

SitOnIt • Seating®

**Price List** December 1, 2021



# TABLE OF CONTENTS

## Intro

Sustainable Design.....	2
Warranty .....	3
Ordering Information .....	6
CAL 133.....	10
Fabric .....	12
COM/COL.....	13
COM/COL Test Request Form .....	14

Custom Upholstery Form .....	15
COM Calculation .....	16
COM/COL Yardage: Task and Conference.....	17
COM/COL Yardage: Multipurpose and Side .....	21
COM/COL Yardage: Lounge .....	24
Custom Finish Program.....	27

## Task, Light Task, Executive and Conference Chairs and Stools

### Amplify

Mesh Back Task Chair.....	33
Mesh Back Task Stool.....	37
Upholstered Back Task Chair.....	41
Upholstered Back Task Stool.....	45

### Anytime

Light Task Chair and Task Stool.....	48
--------------------------------------	----

### Focus

Mesh Back Task Chair.....	51
Mesh Back Task Stool.....	56
Upholstered Back Task Chair.....	60
Upholstered Back Task Stool.....	65

### Focus 2.0

Mesh Back Task Chair.....	69
Mesh Back Task Stool.....	74

### Glove Active

Conference Chair .....	78
------------------------	----

### Glove Executive

Conference Chair .....	82
------------------------	----

### Hexy

Task and Conference Chair .....	85
Mesh Back Task Stool.....	89

### InFlex

Light Task Chair and Task Stool.....	93
--------------------------------------	----

### Ioniq

Collaborative Chair.....	97
--------------------------	----

### Knack

Task Chair.....	100
Task Stool.....	104

### Lumin

Light Task Chair and Task Stool.....	107
--------------------------------------	-----

### Mavic

Collaborative Chair.....	111
--------------------------	-----

### Movi

Light Task Chair and Stool .....	114
----------------------------------	-----

### Non-Stop

Heavy Duty Task Chair .....	117
Heavy Duty Task Stool .....	120

### Novo

Mesh Back Task Chair.....	123
Mesh Back Task Stool.....	128

### OnCall

Light Task Chair and Task Stool.....	132
--------------------------------------	-----

### Orbix

Light Task Chair and Stool .....	136
----------------------------------	-----

### Prava

Conference Chair .....	139
------------------------	-----

### ReAlign

Task Chair.....	143
Task Stool.....	147

### Relay

Light Task Chair and Task Stool.....	150
--------------------------------------	-----

### Rio

Light Task Chair and Task Stool.....	154
--------------------------------------	-----

### Sona

Conference Chair .....	158
------------------------	-----

### Torsa

Task Chair.....	162
-----------------	-----

# TABLE OF CONTENTS

## Task, Light Task, Executive and Conference Chairs and Stools (Cont.)

### TR2

Task and Executive Chair .....	166
Task Stool.....	170

### Vectra

Mesh Back Task Chair.....	174
---------------------------	-----

### Wit

Mesh Back Task Chair.....	178
Mesh Back Task Stool.....	182
Thintex Back Task Chair.....	186
Thintex Back Task Stool.....	190

## Multipurpose, Side and Guest Chairs ; Counter and Bar Stools

### Achieve

Multipurpose Chair.....	198
-------------------------	-----

### Anytime

Multipurpose Chair and Bar Stool.....	201
---------------------------------------	-----

### Baja

Multipurpose Chair and Bar Stool.....	205
---------------------------------------	-----

### Cora

Multipurpose Side Chair.....	210
------------------------------	-----

### Cora

Replacement Seating Parts.....	214
--------------------------------	-----

### Focus Side

Multipurpose Chair, Counter and Bar Stool .....	215
---	-----

### Freelance

Multipurpose Chair, Counter Stool and Bar Stool.....	220
Bariatric Chair.....	226

### InFlex

Multipurpose Chair, Counter Stool and Bar Stool.....	229
--	-----

### Ioniq

Guest Chair .....	233
Multipurpose Chair .....	235

### Kickstand

Stool .....	237
-------------	-----

### Lumin

Multipurpose Chair, Counter Stool and Bar Stool.....	239
--	-----

### Mika

Multipurpose Chair and Bar Stool.....	244
---------------------------------------	-----

### Movi

Nester Chair .....	247
--------------------	-----

### OnCall

Multipurpose Chair and Bar Stool.....	250
---------------------------------------	-----

### Orbix

Multipurpose Chair and Bar Stool.....	254
---------------------------------------	-----

### Qwiz

Nester Chair .....	258
--------------------	-----

### Relay

Multipurpose Chair.....	262
-------------------------	-----

### Relay

Nester Chair .....	265
--------------------	-----

### Rio

Multipurpose Chair, Counter and Bar Stool .....	268
---	-----

### Rowdy

Multipurpose Chair.....	272
-------------------------	-----

### Sprout

Multipurpose Chair.....	275
-------------------------	-----

### Wit Side

Mesh Back Multipurpose Chair.....	278
Thintex Back Multipurpose Chair.....	281

# TABLE OF CONTENTS

## Lounge

### Aviera

Guest and Bariatric Seating .....	291
Hip Chair .....	296
Patient Seating .....	300
Freespan Multiseating .....	305
Preconfigured Tandem Multiseating .....	310
Start/Center/End Tandem Multiseating .....	315
Linking Tables .....	320

### Aviera

Replacement Seating Parts .....	323
---------------------------------	-----

### Cameo

Seating and Benches .....	324
Inline and Coffee Tables .....	329

### Composium

Curve Club Chair, Settee and Sofa .....	331
Flair Club Chair, Settee and Sofa .....	336
Sharp Club Chair, Settee and Sofa .....	341
Ottoman and Benches .....	346

## Tables and Desks

### Mezzanine

Cube End Table, Coffee Table and Corner Table .....	397
Occasional Table .....	400

### Ocala

Flip-Top Tables .....	403
-----------------------	-----

### Parallon

Flip-Top and Fixed Top Training Table .....	406
Café and Occasional Table .....	412

### Switchback

2-Leg Height-Adjustable Table Bundle .....	416
2-Leg Height-Adjustable Table .....	421
3-Leg Height-Adjustable Table Typical .....	425
3-Leg Height-Adjustable Table .....	428

## Benching

### Prise

Benching Typical .....	456
Benching .....	461

### Envoi

Lounge Seating .....	351
----------------------	-----

### Gobi

Lounge Seating .....	355
----------------------	-----

### Nano

Modular Lounge Typical .....	359
------------------------------	-----

### Nano

Modular Lounge .....	365
----------------------	-----

### Paséa

Modular Lounge Typical .....	369
Modular Lounge .....	374
Tables and Ottomans .....	382
Inline Tables .....	386

### Visit Modular

Lounge Seating .....	389
----------------------	-----

### Tensor

Café, Classroom, and Office Typical .....	437
Café Table .....	440
Multipurpose Table .....	443
Desking .....	446

### Uni

Laptop Table .....	453
--------------------	-----

## Power Beam

### eBEAM

Power + Data Beam .....	473
-------------------------	-----

# TABLE OF CONTENTS

## Screens

### Doodle

Markerboard Worksurface Screen .....	481
--------------------------------------	-----

### Modesty

Worksurface Screen .....	484
--------------------------	-----

### Motif

Fabric Worksurface Screen .....	486
Mobile + Freestanding Fabric Screens .....	492

## Monitor Arms

### King Cobra

Monitor Arm .....	512
-------------------	-----

### Mobio

Monitor Arm .....	514
-------------------	-----

## Accessories

Anti-Fatigue Mat.....	520
CPU Storage .....	521
Keyboard Tray .....	522
Laptop Storage .....	523
Lighting: Rhythm .....	524
Mobile Pedestal.....	525

## Appendix

Stand-Alone Tabletops.....	533
Heavy Duty Series Guide .....	536
Stacking Guide.....	538
Glide Guide.....	540
Care and Cleaning.....	541

### Sector

Acrylic Worksurface Screens .....	495
Mobile + Freestanding Acrylic Screen .....	498
Acrylic Seating Screens .....	500
Acrylic Café Screens .....	503
Acrylic Transaction Screen.....	505
Tri-Fold Acrylic Meeting and Single-Table Screen .....	507

### Unity G2

Monitor Arm .....	517
-------------------	-----

Pencil Storage.....	527
Power: Current .....	528
Power: EON.....	529
Sit-to-Stand: High Tide .....	530
Wire Management: Cable Caddy .....	531

Color Program .....	543
Arm Adjustment Guide .....	545
Mechanism Function Guide .....	549
Executive and Conference Chair Options .....	552
Multipurpose Chair Options .....	557

# SitOnIt • Seating®

## CALIFORNIA BORN AND BRED

We're a leading manufacturer of commercial solutions in the U.S.—and #1 in task chairs. From tables and lounge to screens and more, we've been the go-to destination for comprehensive, build-to-order solutions for almost 25 years.

We combine award-winning design with the fastest lead times around (choose from 2-, 5- or 10-day shipping). We can build almost any specification you want, deliver it when you need it and offer a price no one can match. It's all part of our indie California spirit and drive to help you do more.

### DESIGN THAT GETS YOU

Discover seating engineered around you. Experience responsive design, supreme comfort and hyper-customizable features—all at value-driven prices.

### OUR BUILD-TO-ORDER PROMISE

Custom-designed chairs, no waiting. Our nimble size and lean manufacturing operation means we can ship build-to-order chairs in just two days.

### FASTEST SHIPPING IN THE INDUSTRY

Choose from two, five, or 10 day shipping. We cut lead time, sync orders and avoid off-schedule shipments at a rate our competitors just can't match.

### WORLD-CLASS SERVICE

We're proud to announce that the Office Furniture Dealer Alliance voted for us as "Best Customer Service" three times in the past five years.

# SUSTAINABLE DESIGN

We make it easy to go green. Design an eco-friendly room from the ground up or upgrade an existing space to meet the latest environmental standards.



## ANSI/BIFMA Certified

SitOnIt Seating is a member of the Business and Institutional Furniture Manufacturer's Association (BIFMA). Tests developed by BIFMA are approved by the American National Standards Institute (ANSI) to determine the strength and durability of seating. Although testing is not a warranty or guarantee, our task, side and lounge products meet or exceed BIFMA and ANSI standards.



## LEED Certified

Earn points toward LEED certification thanks to our U.S. manufacturing location and our use of recycled materials where possible.



## GREENGUARD Certification

All SitOnIt Seating lounge and seating products met the rigorous criteria required by GREENGUARD in accordance with the Collaborative for High Performance Schools.



## LEVEL Certified

Sustainability matters. That's why we've worked to achieve BIFMA LEVEL® certification for all task chairs, side chairs and lounge products.



## The Take Back Program

SitOnIt Seating helps minimize product waste by connecting our customers and dealers with third-party groups who redirect materials that would be headed for the landfill to local nonprofits and public agencies.



## We Did Our Homework

Download detailed documents that break down the percentage of recycled content, manufacturing processes and indoor air emissions for every chair we make.

# WARRANTY

## Product Warranty Periods

Exemplis LLC, d.b.a. SitOnIt Seating (hereafter referred to as the Company), warrants to the original end user that this product will be free from defects in its material and workmanship when used in a single shift (standard eight-hour day, five days per week) for the following warranty periods:

### LIFETIME WARRANTY COVERAGE:

- All SitOnIt Seating products, except where noted below
- Structural Components: Parallon, Prise, eBEAM, Switchback and Voyager

### 12-YEAR WARRANTY COVERAGE:

- Amplify, Cora Guest, Novo, Torsa, and Wit used in multi-shift (24/7) applications
- Lounge seating and occasional/lounge tables
- Bases: Ocala, Tensor
- Laminate tops
- Monitor arms<sup>1</sup>: King Cobra, Mobio series, Unity G2
- Plastic shells

### 10-YEAR WARRANTY COVERAGE:

- Non-Stop Heavy Duty, Cora Midsize and Bariatric, Freelance Bariatric and chairs purchased with a Heavy Duty (HD) or Large and Tall (LT) option used in multi-shift (24/7) applications
- Electrical Components: Parallon, Prise and eBEAM

### SEVEN-YEAR WARRANTY COVERAGE:

- Electrical Components<sup>2</sup>: Parallon, Switchback and Voyager

### FIVE-YEAR WARRANTY COVERAGE:

- Fabric, foam, knit back, and mesh
- All filing products<sup>3</sup>
- CPU holders
- Screens<sup>4</sup>
- High Tide
- Keyboard trays
- Lighting fixtures
- Power components<sup>5</sup>: EON, Current, Power Strips
- Wire management

### TWO-YEAR WARRANTY COVERAGE:

- Fabric and foam cushioning for Non-Stop Heavy Duty, Freelance Heavy Duty, Cora Midsize and Bariatric and chairs purchased with an HD or LT option
- Multipurpose felt glides
- Half-Moon Pencil Drawer

### ONE-YEAR WARRANTY COVERAGE:

- Lighting power supplies
- Mouse pads
- Wrist rests

*1. Weight capacity of the monitor arms must be followed. If an arm is not functioning properly because of the weight of the monitor is outside of the advertised weight capacity, the monitor arm will not be considered defective under the warranty.*

*2. Please note that electrical components on a height-adjustable table include: hand controls, motors, control boxes and electrical cables.*

*3. This warranty does not cover damage from ordinary wear and tear, including paint finish changes and/or discoloration resulting from aging or exposure to light.*

*4. Warranty limited to finishes, tacking surface of tack boards and writing surface of whiteboards. Standard textiles limited to original manufacturer's warranty.*

*5. Power components are defined as any power unit with electrical outlets and/or USB/data connections, connector jumper cables for daisy chain and infeeds for hardwire applications.*



# WARRANTY

## Freight Warranty

At SitOnIt Seating™, we take pride in crafting one-of-a-kind pieces. Products are thoughtfully inspected prior to being carefully wrapped and packed for shipment. Upon receiving your order, should your order be less than perfect, please follow these steps for an expedited resolution:

### IF DAMAGE IS VISIBLE:

- Please accept shipment and report damages on the freight bill.
- Contact SitOnIt Seating Customer Experience to report the issue **within 10 days** after delivery.

### IF DAMAGE IS CONCEALED:

- Save merchandise and packaging.
- Take a photo to document the damage.
- Contact SitOnIt Seating Customer Experience to report the issue **within 60 days** after delivery.

Either way, we are here to help! SitOnIt Seating Customer Experience Team is on standby to assist Monday through Friday, 5:00 a.m. to 5:00 p.m. PST. Call (888) 274-8664 or email [sitonit@exemplis.com](mailto:sitonit@exemplis.com).

## The Company Does Not Warranty

- COM/COL textiles
- Product abuse or misuse
- Failure resulting from normal wear and tear
- User modification of or attachments to the product
- Products or parts not used, maintained or installed in accordance with the Company's installation, maintenance and/or applicable guidelines
- Products that are exposed to extreme environmental conditions and/or have been subject to improper storage
- Floor samples or display models
- The substitution or use of non-SitOnIt Seating components with SitOnIt Seating products
- Products purchased "as is" and/or secondhand
- Products sold by unauthorized dealers
- Creasing and/or gathering of textiles during upholstery application process
- Minor irregularities of color, surface, grain and texture
- Minor variations of color in textiles
- Variations of texture and natural markings such as neck wrinkles, scratches, backbone marks and stretch marks in leather
- Color matching of textiles exactly to samples, swatches or prior purchases

# WARRANTY

## Applicable Provisions To All Products And Services

The Company will repair or replace with a comparable product, at its option, without charge to the original purchaser, only defective products or parts found defective during the Warranty Period. If requested by the Company, the original purchaser must return the part or product with freight or other shipping charges prepaid.

This warranty shall be effective for the applicable time period beginning from date of purchase as shown on original purchaser's original receipt or other proof of purchase.

For products purchased on or after August 1, 2012, the Company shall pay for all labor costs pre-approved by the Company. The payment of such pre-approved labor costs will be in the form of a credit to an active Company account.

There are no other warranties, expressed or implied, other than those specifically described, including, without limitations, any implied warranty or merchantability or of fitness for a particular purpose. The Company will not be responsible for incidental or consequential damages. Some states do not allow the exclusion or limitation of incidental or consequential damages, so the above limitations or exclusions may not apply to you. This warranty gives you specific legal rights and you may have other rights which vary from state to state.

Warranty claims must be reported within 60 days of any concealed damage. The Company will advise you of the procedure to follow when making warranty claims. Call the Company at the number below to explain the defect. Give your name, address and telephone number. Please be prepared with the model number and sales order number found under the seat of the chair.

SitOnIt Seating: (888) 274-8664

# ORDERING INFORMATION

## Pricing

All prices are suggested retail and are subject to change without notice. Visit our websites or contact Customer Experience for the latest pricing. Prices in effect at the time of shipment will prevail. We reserve the right to make changes in prices, models, fabrics, finishes, materials and specifications and also discontinue models and options at any time without notice.

## Orders

Specify model number, quantity, desired delivery date and all other applicable information. Order templates can be found in the applicable Price Guide. Orders will be accepted with an acknowledgment form governing the transaction. In the event an error is made in the manufacture of the product, the acknowledgment will be used as the resolution document. Submit orders by email or fax:

### SITONIT SEATING:

Email: [purchaseorder@exemplis.com](mailto:purchaseorder@exemplis.com)

Fax: (714) 995-4855

## Minimums

### FREIGHT PROGRAM

The freight program is designed to deliver freight prepaid to the designated consignee. To offset rapidly increasing costs, it requires a minimum quantity (three or more items) for select product categories. Premium freight services and/or guaranteed delivery may result in additional shipping charges.

### NO MINIMUM REQUIREMENT:

- Task/Collaborative/Conference/Executive seating and task stools
- Side, nesting seating and stools
- Plastic seating
- Height adjustable tables (except tops)\*
- Fixed and adjustable benches (except tops)\*
- Power beam
- Training/meeting/Café/Occasional tables (except tops)\*
- Ergonomic accessories (e.g. monitor arms, keyboard trays, wire management, desktop sit-to-stand, anti fatigue mats, power solutions)
- Screens
- Storage
- WFH products

*Note: The tops for these products will have a minimum requirement of four units. Uni table ships in a single packet and the top is not subject to minimum four rule.*

## Minimums (Cont.)

### 3-UNIT MINIMUM:

- Lounge seating
- Tandem seating (Aviera)

*Note: Products that do not require a minimum can be combined with those that require 3-unit minimum to reach the minimum quantity. If the minimum is not met, the order will incur a \$95 net surcharge per order.*

### 4-UNIT MINIMUM:

- Tabletops/worksurfaces

*Note: Tabletop/worksurface orders that don't reach the minimum of 4 tops will incur a \$95 net surcharge per order even if they're part of a larger order.*

### EXAMPLES

- Order A: 1 Rio chair, 1 Wit chair, 1 Gobi – no surcharge
- Order B: 1 Gobi, 1 Envoi - \$95 surcharge because the number of lounges is less than minimum 3 and there are no other products in the order
- Order C: 1 Aviera, 1 Mobio arm, 1 Motif screen – no surcharge
- Order D: 1 eBeam, 1 EON, 1 Switchback base, 1 Switchback top - \$95 surcharge because the number of tops is under the required four tops minimum
- Order E: 3 Switchback tables with tops - \$95 surcharge because the number of tops is under the required four tops minimum

## Quantity Discounts

Quantity discounts for CAL 133 textiles and some shipping methods are available. See the appropriate Price Guide or contact Customer Experience for more information.

## Change Orders

Orders that have been scheduled for production may not be changed. All changes on customer orders previously acknowledged must be requested in writing and are subject to approval. Requests for changes are not deemed accepted until acknowledged. In the event a revision is accepted, change fees may apply.

# ORDERING INFORMATION

## Lead Time

We have thousands of carded textiles—including vinyl and leather—that ship in two, five or 10 days. For a complete listing of textile lead times, see the Carded Textile Program section of the **Textile Reference Guide** or visit the **Materials tab** on our websites. Graded-in, COM and COL orders start production when the textile arrives from the manufacturer. Because of this the lead time on Motif screens or upholstered chairs is two, five or 10 days based on the textile selection.

### TWO-DAY

- Anti-Fatigue Mat
- Corner Sleeve
- CPU Holders
- Current power
- High Tide
- Keyboard Mechanisms (Lift and Lock, Premium Lift and Lock, Sit-to-Stand)
- Keyboard Trays (Longboard, Crescent Board, Mini Platform, Laptop Tray, Adapter)
- Laptop Drawer
- Mobile Pedestals
- Monitor Arms
- Ocala Bases
- Pencil Storage
- Plastic Shells
- Switchback Bases
- Tensor Bases
- Value Lighting
- Voyager 2-Stage/3-Leg Bases
- Wire Management

### THREE-DAY

- Doodle Screens
- Mobile Pedestal Cushions
- Modesty Screens
- Motif Screens
- Parallon Tables
- Prise Benching
- Sector Screens
- Standard Worksurfaces

### 10-DAY

- Lounge

### 15-DAY

- Stain-to-Match

### 21-DAY

- Tablet Arm

### 30-DAY

- Custom Laminate

## Holds

Orders received by 10 a.m. PST begin assembly the next day. Orders that are “On Hold” will begin production only when all holds are released. Customer Experience will notify you of any holds placed on your order.

Types of holds include:

- Credit Hold for issues related to billing and invoicing.
- Incomplete Hold if the purchase order is incomplete or illegible.
- Pricing Hold if the price on the purchase order does not match the pricing shown in the Price Guide or in our computer system.
- New Fabric Hold for nonstandard textile orders without an inventory part number.
- Graded Hold is placed by the Purchasing Department while confirming delivery of graded fabric from the vendor.

## Large Orders

Large orders may require additional lead time:

### 25 UNITS

- Cameo
- Composium
- Envoi
- Gobi
- Nano
- Paséa
- Visit Modular

### 50 UNITS

- Aviera
- Benching
- Screens
- Tabletops
- Tensor Bases
- Parallon Bases

### 150 UNITS

- Accessories
- Height-Adjustable Table Bases
- Lighting
- Monitor Arms
- Ocala Bases
- Power
- Sit-Stand (Desktop)

### 250 UNITS

- Task Chairs/Stools
- Side Chairs/Stools

# ORDERING INFORMATION

## Product Modification

Special requests are available and additional charges will be determined per quotation. Up to five working days are required after the special request is received to prepare a quotation. Contact Customer Experience for details.

## Orders for Parts

Multiple shipments may occur for orders that include parts. Hardware such as casters or cylinders will ship separately from items requiring upholstery or manufacturing labor. Components such as casters or cylinders will ship separately from new chairs.

## Product and Design Changes

We reserve the right to discontinue product lines, models and parts at any time. We also reserve the right to make changes in design and material when such action is deemed to be an improvement in design, function and/or construction.

## Cancellation and Returns

Orders that have entered any stage of production cannot be canceled. Request for cancellations are not accepted until acknowledged. In the event a cancellation is accepted, canceled charges may be imposed for the entire amount of the order. Authorization for return must be requested from and approved by Customer Experience prior to the return of the merchandise. Returns may be subject to a restocking charge equivalent to 40% of the net order plus freight. Unauthorized returns will not be accepted.

## Shipping

Standard shipments are made via common carrier, unless otherwise specified. Special routing requests made by the customer or the consignee may result in additional charges.

Standard deliveries are dock-to-dock and are scheduled to occur Monday through Friday between 8 a.m. and 5 p.m., based on our published transit times. We will not be held responsible for issues or costs arising from carrier transit delays, missed delivery appointments, etc.

We reserve the right to charge for nonstandard customer delivery requirements that may include order deliveries, inside deliveries, etc. For information concerning these charges, contact Customer Experience.

## Freight Terms

Freight terms apply to the continental U.S. only. This excludes Alaska and Hawaii. All standard transportation services and freight costs are included in the price of our products. We ship freight prepaid and allowed, FOB and origin.

Shipments outside the contiguous U.S. are shipped to the point of embarkation free of charge, if the shipment meets the minimum requirement. All subsequent freight charges will be at the customer's expense, shipped collect.

Because of the fluctuation of fuel prices, we reserve the right to impose fuel surcharges for any shipments.

## Freight Damage

We are not responsible for product damage occurring in transit or during storage. Before accepting a shipment from the carrier, carefully review the packing list and inspect the quantity and condition of the items. Promptly document all visible damage on the Bill of Lading and request a carrier inspection of the product. In the event of damage, accept the order and contact Customer Experience for issue resolution. Concealed damage must be reported in writing within 60 days of accepting delivery. We will take all reasonable steps to assist customers in resolving claims for loss or damage.

## Smart Delivery

Smart Delivery provides precise order delivery within a customer-specified date and time window. This special service is available in the contiguous U.S. and includes inside delivery, non-dock delivery, weekend delivery and residential delivery.

Requests must be made prior to an order being scheduled for production. A Smart Delivery fee will be added to the original order invoice. Any changes to a submitted Smart Delivery order will require a new Smart Delivery quote request. Not all change requests can be honored. Changes to an order will result in delays and/or additional costs once the order is in transit.

The Smart Delivery fee will be refunded if the shipment does not arrive within the specified delivery window. We will not be held responsible for costs or damages associated with delayed deliveries.

Please contact Customer Experience to request a Smart Delivery quote or for more information.

## Will Call

Customers with Will Call orders will be notified once orders are ready to be picked up. Customers will have three business days from notification to pick up the order. If the order is not picked up within this time frame, storage charges will start at a rate of \$30 per business day until the order has been claimed.

## Invoicing

Invoicing is triggered when the product ships.

Fire safety is a top priority for us. SitOnIt Seating strongly supports CAL 133 standards and makes it easy for designers and buyers to specify CAL 133 chairs.

## TB 117

Under California law, all upholstered furniture must meet TB 117-2013 by January 1, 2015. At a minimum, all SitOnIt Seating fabrics, vinyl, leathers and resilient filling material (i.e., foam and Dacron) meet TB 117-2013. Unlike TB 117-2013, which tests only the inner upholstery components, with CAL 133 the entire piece of furniture must withstand ignition from a gas burner inside a testing chamber.

## What is CAL 133?

CAL 133 is a standard of furniture flammability started by the California Bureau of Home Furnishings and Thermal Insulation for furniture used in public buildings such as healthcare facilities, convalescent homes, public assembly areas of hotels and motels, hospitals, board and care homes, stadiums, licensed child care facilities, prisons and jails.

Notice: Starting January 1, 2020, the State of California changed regulations to ban flame retardants in upholstered furniture sold in California. We anticipate further regulatory changes in other states. The TB-133 barrier material used in our products is a flame-retardant fabric designed to pass open-flame testing protocols. The cotton/fiberglass knit is infused with a phosphorus flame retardant and coated with a chemical that expands in heat to create a physical flame barrier. The TB-133 barrier material that we use in our products is free of halogenated flame retardants, polybrominated diphenyl ethers (PBDE), formaldehyde, and antimony.

## Choosing CAL 133 Textiles

Consult the individual **SitOnIt Seating fabric cards** to review the specifications for each fabric offered. Because we offer such a vast array of fabrics with varying degrees of flame retardancy, we suggest you consult the published technical data of the fabric supplier when making your fabric selection.

Specify CAL 133 textiles in the Material section of the Final Price Calculation worksheet or on your purchase order.

SitOnIt Seating assumes no responsibility for the flame retardancy of any customer-provided textile.

## CAL 133 Testing

CAL 133 is a full-scale fire test for furniture manufactured for use in public buildings. The standards do not specify how to construct furniture, but only how it should perform when tested. To pass this fire standard test, a fire blocking liner is sandwiched between the foam and the fabric of our chairs. This liner acts as a fire extinguisher by smothering the flame.

COM/COL compliance for the CAL 133 models listed on the following page can be determined by specifying upholstery with the exact characteristics as approved SitOnIt Seating fabrics and leathers or by conducting a full chair burn test. The nondiscountable test fee for each chair-textile combination is listed below. The lead time for testing is four weeks.

Task and Side Chairs/Stools: \$600  
Lounge: \$800

For more information on TB 117-2013 and CAL 133, visit the **State of California Department of Consumer Affairs** website.

## To Order CAL 133

Allow a 10-day lead time. Clearly specify CAL 133 on your order. For each chair, add the appropriate additional charge.

## CAL 133 Materials

- **CAL 133 LEATHER:** All carded leather is CAL 133 approved.
- **CAL 133 PLASTIC:** All our plastic chairs are CAL 133 approved except for our Achieve and Baja collections.
- **CAL 133 TEXTILES:** Over a thousand CAL 133 approved textiles in all grades, colors and styles are listed on the SitOnIt Seating website. Visit [sitonit.net](http://sitonit.net) and search textiles by CAL 133 compliance, manufacturer, grade, lead time and other attributes.

## To Check Seating for CAL 133

To determine whether your current SitOnIt Seating chair meets CAL 133, or to check an order you have recently received, check the bottom of the chair seat pan for the label shown below. If your chair does not have this tag, your chair does not meet CAL 133.

### NOTICE

This Article is manufactured for use in public occupancies and meets the flammability requirement of California Bureau of Home Furnishings technical bulletin 133. Care should be exercised near open flame or with burning cigarettes.

## CAL 133 Approved Models

The following models, when combined with approved textiles and blocker, meet the CAL 133 standard.

### MULTIPURPOSE CHAIRS AND STOOLS

- Achieve: Upholstered
- Anytime: Upholstered and all plastic colors - A48, A49 (arm and armless)
- Focus Side: Upholstered and all mesh colors - A130 (arm and armless)
- Freelance: Upholstered and all plastic colors (arm and armless)
- InFlex: Upholstered and all plastic colors: A121, A122 (arm and armless)
- Lumin: Upholstered and all plastic colors
- Mika: All models
- Movi: All mesh colors
- Non-Stop Heavy Duty: A67, A68, A69, A70, A71, A72 (arm and armless)
- OnCall: Upholstered and all plastic colors - A37FR, A42FR (arm and armless)
- Qwiz: All models
- ReAlign: A73, A74, A75, A76, A77 (arm and armless)
- Relay: Upholstered and all plastic colors - A60, A61 (arm and armless)
- Rio: Upholstered and all plastic colors (arm and armless)
- Rowdy: Upholstered and all plastic colors - A47 (arm and armless)
- Wit Side: All mesh colors (arm and armless)

## CAL 133 Approved Models

### TASK CHAIRS AND STOOLS

- Amplify: Upholstered and all mesh colors
- Focus: A91, A92, A93, A94, A95 (arm and armless)
- Knack: A77, A80, A81 (arm and armless)
- Mavic: All models
- Novo: All mesh colors (arm and armless)
- Prava: A105, A106, A108, A109, A111, A112 (arm and armless)
- Sona: A101, A102, A105, A106, A108, A109 and all knit colors (arm and armless)
- Torsa: All mesh colors (arm and armless)
- TR2: A12FR, A15FR, A17FR, A43FR, A44FR (arm and armless)
- Wit: All mesh colors (arm and armless)

### LOUNGE SEATING

- Aviera: Metal and Wood
- Cameo
- Compositum
- Envoi
- Gobi
- Nano
- Paséa
- Visit Modular



## Unmatched Matching®

Textiles can be everything. With the right fabrics, you can provide atmosphere, create cohesiveness and offer an unforgettable experience across many spaces and places.

Fabric color, alignment, texture, orientation and pattern all play a part—and need to line up or match perfectly (especially with field-replaceable parts). With PatternMatch and pattern orientation, you can rest assured that every part of every chair can be traded out easily without disrupting design.

## PatternMatch®

We ensure that design elements of the back, seat and arms match and/or align between seat and back. The patterns or lines also match unit-to-unit.

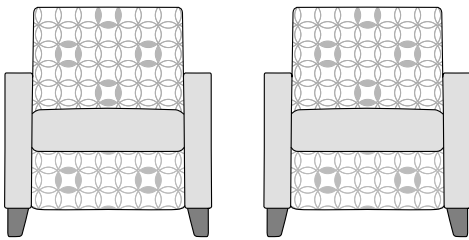

## Pattern Orientation

All fabric (vertical, horizontal or bi-directional pattern) will be applied in the direction shown on the fabric manufacturer's website, unless otherwise specified.

To ensure desired fabric direction, use the Custom Upholstery Order Form on page 15 and check the appropriate box under the "Pattern Orientation" section.

When we apply a textile pattern with lines at a 90-degree angle (vertically and/or horizontally) to the back and seat of a chair, we strive to achieve full alignment. Some small variations can occur due to the shape and size of the product. Pattern Orientation is standard for SitOnIt Seating.

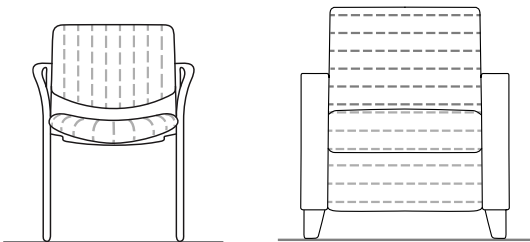

## Multi-Upholstery

The multi-upholstery option allows one fabric to be selected for the back and a different fabric for the seat. Multi-upholstery lounge pricing is different than multi-upholstery pricing for task and side seating.

### TASK AND SIDE

- Upholstery pricing is based on both seat and back being the same textile. If the material is COM/COL or more than one textile is used:

**If two fabrics of the same grade are chosen,**

one grade level will be added to the upholstery price.

Example: grade 4 for the seat and a different grade 4 for the back, the upholstery price will be grade 5 for both.

**If two fabrics of different grades are chosen,**

the final upholstery price will be based on the highest grade.

Example: grade 2 for the seat and grade 3 for the back, the upholstery price will be grade 3 for both.

*The above upcharges only apply to chairs that have both the seat and back upholstered.*

### LOUNGE AND CORA

- A standard upcharge applies to all multi-upholstery orders. Different fabrics and grades may be combined because each back, seat, arm and valance are separately priced.
- Add the single multi-upholstery upcharge to the cost of the components. Example: upcharge + any grade price for the seat + any grade price for the back + any grade price for the arm.

## Moisture Barrier

Accidents happen. To help protect your investment, moisture barrier for seats and backs is an option on all lounge seating products.

Specify moisture barrier seats and/or backs in the Material section of the Final Price Calculation worksheet or on your purchase order. Note that specification and pricing are separate for seat and back and apply to each single seat or back position.

## COM/COL Warranty

Any textiles applied to furniture orders through the COM/COL process will not be covered under warranty by SitOnIt Seating. Any warranty claims for these upholstery materials will fall to the original vendor of the fabric. With a broad spectrum of harsh cleaning agents used by facilities, SitOnIt Seating recommends that the owner test each fabric selection with their specific cleaning methods before using. Additionally, SitOnIt Seating is not held responsible for receipt of defective fabrics, as we apply all COM as first-quality goods.

## CAL 117 Policy

SitOnIt Seating assumes no responsibility for the fire retardancy of any COM/COL. Customers are solely responsible for making sure that their COM/COL complies with all applicable codes and regulations. For information on CAL 133, refer to page .

## COM/COM Excess Yardage

SitOnIt Seating is not responsible for yardage submitted to us beyond the required amount. Excess COM/COL materials will be discarded at the discretion of SitOnIt Seating unless otherwise instructed by the customer at the time the order is placed. If a customer requires the COM/COL excess yardage returned, they must contact Customer Experience to make arrangements. The customer will be responsible for delivery charges.

## COM/COL Process

1. Visit the **SitOnIt Seating Textile Compatibility** tab on our website to see if your COM/COL textile has already been approved.

(If your textile is already approved, skip to step 3. If it hasn't been previously approved, go to step 2.)

2. Send a 12" × 12" textile swatch to be tested for approval along with a completed COM/COL Test Request Form found on the next page.

Note: Freelance back, InFlex back, Focus Side back and Achieve back require 0.75 yards of fabric to be sent for testing.

Allow two business days once your textile is received for the test results to be available on the **SitOnIt Seating Textile Compatibility** tab on our website.

Send the textile swatch and form to:

**SITONIT SEATING**

Attn: COM Engineer  
6280 Artesia Blvd.  
Buena Park, CA 90620

3. If the COM/COL swatch is approved, fill out the Customer Upholstery Form located on page page 15. and attach with your order.
4. Ship the necessary amount of COM or COL material and the purchase order number to:

**SITONIT SEATING**

Attn: COM Engineer  
6280 Artesia Blvd.  
Buena Park, CA 90620

# COM/COL TEST REQUEST FORM

Please complete one form for each model and/or textile that needs to be tested.

## Contact Information

Dealer \_\_\_\_\_ Contact Name \_\_\_\_\_

Address \_\_\_\_\_ City \_\_\_\_\_ State \_\_\_\_\_ Zip \_\_\_\_\_

Phone \_\_\_\_\_ Fax \_\_\_\_\_ Email \_\_\_\_\_

## Product Information

Product Name \_\_\_\_\_ Model Number \_\_\_\_\_

## Textile Information

Manufacturer \_\_\_\_\_ Pattern \_\_\_\_\_ Colorway \_\_\_\_\_

## Shipping Information

The 12" x 12" textile swatch and this form can be sent to:

**SITONIT SEATING**  
Attention: COM Engineer  
6280 Artesia Blvd.  
Buena Park, CA 90620

Please allow five business days once the fabric is delivered for your test results to be available on the **SitOnIt Seating Textile Compatibility** tab of our website. If you need further assistance, please contact Customer Experience at (888) 274-8664.

*Note: Freelance back, InFlex back, Focus Side back and Achieve back require 0.75 yards of fabric to be sent for testing.*

# CUSTOM UPHOLSTERY FORM

For all COM/COL orders or standard orders with custom textile upholstery directions, please complete one form for each model and/or textile.

## Contact Information

Dealer \_\_\_\_\_  
 Address \_\_\_\_\_  
 Phone \_\_\_\_\_ Fax \_\_\_\_\_

Contact Name \_\_\_\_\_  
 City \_\_\_\_\_ State \_\_\_\_\_ Zip \_\_\_\_\_  
 Email \_\_\_\_\_

## Order Information

Purchase Order Number \_\_\_\_\_ Sales Order Number \_\_\_\_\_

## Product Information

Product Name \_\_\_\_\_ Model Number \_\_\_\_\_ Quantity \_\_\_\_\_

## Textile Information

Manufacturer \_\_\_\_\_ Pattern \_\_\_\_\_ Colorway \_\_\_\_\_

Total Yardage Shipped (for COM/COL) \_\_\_\_\_  
 (To calculate, reference COM Calculation and COM Yardage Requirement beginning on page 16.)

Contains flame retardants: Yes No Prop 65 compliant: Yes No  
 Per California Proposition 65, we are required to note that select textiles may contain chemicals known to cause cancer or reproductive toxicity. To learn more, please visit the Prop 65 web page.

## Fabric Direction

To avoid confusion, you may wish to attach a sample textile with the desired face and direction indicated. Is there a desired top and bottom to the fabric application?

Yes No

Is the fabric either a stripe or two-color plaid?

Yes No

Please refer to our standard and rotated fabric directions to the right. Indicate the desired fabric direction for each applicable component below.

<b>Seat (Ottoman Chassis):</b>	Vertical	Horizontal
<b>Back (Ottoman Top):</b>	Vertical	Horizontal
<b>Arm:</b>	Vertical	Horizontal
<b>Valance:</b>	Vertical	Horizontal

Please attach this form with your order submission.  
 If you are submitting a COM/COL order, make sure to include your PO# with the textile that you mail to our factory:

### SITONIT SEATING

Attn: COM Engineer  
 6280 Artesia Blvd.,  
 Buena Park, CA 90620

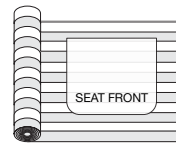
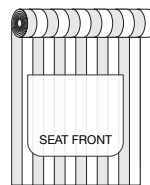

Vertical or Off the Roll Horizontal or Railroaded

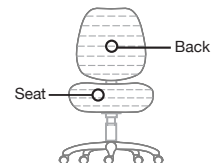
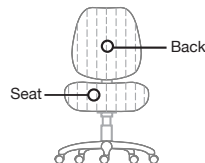
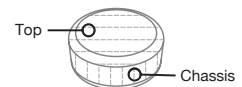
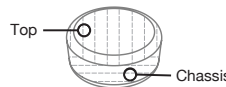
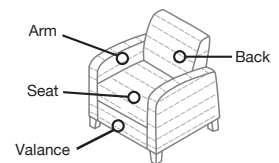
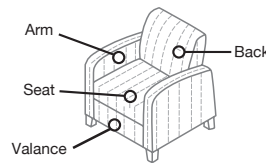

# COM CALCULATION

## Steps to Calculate COM Yardage.

1. Determine which products are being ordered as COM.
2. Find the yardage needed to upholster those products from the COM Yardage Requirement charts.
3. Adjust the yardage requirement total based on the repeat of the fabric roll using the COM Repeat Calculation table.
4. Take the final calculation and round up to the nearest half-yard to get final yardage.

For orders of 10 or more seats, contact Customer Experience for further quoting.

## COM Repeat Calculation.

Use the guide below to calculate the percentage of extra upholstery required to cover large repeats.

Repeat	Railroaded/Horizontal OR Vertical/Off The Roll
5.1"– 7"	10%
7.1"–10"	15%
10.1"–14"	20%
14.1"–20"	30%
20.1"–27"	45%

*Yardage requirements listed in this document are based on textile bolts/rolls that are 54" wide. Please contact Customer Experience if goods are a width other than 54".*

## COM Calculation Example

Below is a hypothetical scenario for how total COM yardage should be determined. This example is for a patterned textile that has a repeat.

### STEP 1: DETERMINE WHICH PRODUCTS ARE BEING ORDERED AS COM

For this example order, we'll assume we need to order: 20 units of Freelance 4-leg—backs only.

### STEP 2: DETERMINE THE COM YARDAGE REQUIREMENT

Looking at the COM Yardage Requirements chart that begins on page 17, we see that the following yardage amounts are needed for each product:

Freelance 4-leg chair back = 0.94 yards.

Now we multiply 0.94 yards by the 20 chair backs and we get a total of 18.8 yards.

### STEP 3: ADJUST THE YARDAGE REQUIREMENT TOTAL BASED ON REPEAT

Since the textile we've chosen is a pattern with a repeat, we should look at the COM Repeat Calculation table to determine our multiplier. For this example, let's assume our repeat is 11" and we're upholstering the fabric vertical/off-the-roll. Based on the table, the multiplier is 20%. Now, we need to take the 18.8 yards from step two and increase it by 20%. An easy way to calculate this is by multiplying 18.8 by 1.2, which gives us 22.6 yards.

### STEP 4: ROUND TO GET THE FINAL AMOUNT NEEDED

To determine how much yardage is needed to complete this order, we take the amount from step three and round it to the nearest half-yard. In this case, that means the customer needs to send SitOnIt Seating 23 yards to complete this order.

# COM/COL YARDAGE: TASK AND CONFERENCE

Combining upholstery is an option on all SitOnIt Seating upholstered products. Below are tables outlining the fabric or vinyl requirements for the entire chair as well as individual pieces. All yardage requirements are quoted in terms of yards for fabric or vinyl and square feet for leather. Please contact Customer Experience for order quantities greater than 10 seats.

	Fabric or Vinyl (In Yardage)			Leather (In Square Feet)		
	Seat and Back	Seat Only	Back Only	Seat and Back	Seat Only	Back Only
<b>Amplify</b>						
Midback Mesh	—	1	—	—	17	—
Highback Mesh	—	1	—	—	17	—
Highback Mesh Large and Tall	—	1.15	—	—	18	—
Highback Upholstered	1.25	1	0.9	23	17	15
Highback Upholstered Large and Tall	1.25	1.15	—	20	18	—
Midback Mesh Task Stool	—	1	—	—	17	—
Highback Upholstered Task Stool	1.25	1	0.9	23	17	15

<b>Anytime</b>						
Light Task and Task Stool	1	0.8	0.75	15	10	8

<b>Focus</b>						
Midback Mesh	—	1	—	—	17	—
Highback Mesh	—	1	—	—	17	—
Midback Upholstered	1.15	1	0.75	23	17	15
Highback Upholstered	1.25	1	0.9	25	17	15
Highback Upholstered Large and Tall	1.25	1.15	—	31	25	—
Midback and Highback Mesh Task Stool	—	1	—	—	17	—
Midback and Highback Upholstered Task Stool	1.15	1	0.75	23	17	15

<b>Focus 2.0</b>						
High Back Mesh	—	1	—	—	14	—

# COM/COL YARDAGE: TASK AND CONFERENCE

	Fabric or Vinyl (In Yardage)			Leather (In Square Feet)		
	Seat and Back	Seat Only	Back Only	Seat and Back	Seat Only	Back Only
<b>Glove</b>						
Active Midback	2.4	1.16	1.18	50	20	25
Active Midback Ballistic Nylon	1.25	1.1	1.15	36	20	20
Active Highback	2.5	1.22	1.28	55	22	32
Active Highback Ballistic Nylon	1.4	1.15	1.2	42	21	22
Executive Midback	3.25	—	—	56	—	—
Executive Midback Ballistic Nylon	2.15	—	—	44	—	—
Executive Highback	3.5	—	—	70	—	—
Executive Highback Ballistic Nylon	2.35	—	—	57	—	—
<b>Hexy</b>						
Task and Conference Chair	—	1	—	—	17	—
<b>Inflex</b>						
Light Task and Task Stool	1	0.85	0.65	15	10	7
<b>Ioniq</b>						
Light Task	—	0.75	—	—	7	—
<b>Knack</b>						
Midback	1.85	1	1.1	32	21	23
Midback Ballistic Nylon	1.55	1	1	27	21	15
Midback Task Stool	1.85	1	1.1	32	21	23
Midback Task Stool Ballistic Nylon	1.55	1	1	27	21	15
<b>Lumin</b>						
Light Task and Task Stool	1	0.85	0.65	15	10	7
<b>Mavic</b>						
Midback Mesh	—	0.8	—	—	14	—
<b>Movi</b>						
Light Task and Task Stool	—	0.75	—	—	10	—

# COM/COL YARDAGE: TASK AND CONFERENCE

	Fabric or Vinyl (In Yardage)			Leather (In Square Feet)		
	Seat and Back	Seat Only	Back Only	Seat and Back	Seat Only	Back Only

## Non-Stop Heavy Duty

Size 1 Stool	1.75	1	1	30	18	20
Size 1 Stool Ballistic Nylon	1.3	1	1	22	18	12
Size 3	2.5	1	1.75	44	17	29
Size 3 Ballistic Nylon	2	1	1.25	35	17	20

## Novo

Midback and Highback Mesh	—	1	—	—	17	—
Highback Mesh Large and Tall	—	1.15	—	—	18	—
Midback and Highback Mesh Stool	—	1	—	—	17	—

## OnCall

Light Task and Task Stool	0.85	0.8	0.6	14	10	8
---------------------------	------	-----	-----	----	----	---

## Orbix

Light Task and Task Stool	—	0.75	—	—	—	—
---------------------------	---	------	---	---	---	---

## Prava

Midback	2	0.75	1.5	35	17	28
Highback	2.25	0.75	1.75	40	17	30

## ReAlign

Midback	2	1	1.6	34	17	28
Midback Ballistic Nylon	1.7	1	1.25	30	17	21
Highback	2.2	1	1.65	40	17	25
Highback Ballistic Nylon	1.75	1	1.35	32	17	25
Midback Task Stool	2	1	1.6	34	17	28
Midback Task Stool Ballistic Nylon	1.7	1	1.25	30	17	21
Highback Task Stool	2.2	1	1.65	40	17	25
Highback Task Stool Ballistic Nylon	1.75	1	1.35	32	17	25

## Relay

Light Task and Task Stool	1	0.75	0.6	15	12	10
---------------------------	---	------	-----	----	----	----



# COM/COL YARDAGE: TASK AND CONFERENCE

	Fabric or Vinyl (In Yardage)			Leather (In Square Feet)		
	Seat and Back	Seat Only	Back Only	Seat and Back	Seat Only	Back Only
<b>Rio</b>						
Light Task and Task Stool	1	0.85	0.65	15	10	7
<b>Sona</b>						
Midback Knit	–	1	–	–	17	–
Midback Upholstered	1.75	1	1.25	32	17	21
<b>Torsa</b>						
Highback Mesh	–	1	–	–	17	–
<b>TR2</b>						
Midback	1.5	1	0.9	25	18	18
Midback Ballistic Nylon	1.25	1	0.9	20	18	10
Executive	2	1.25	1.1	36	20	20
Executive Ballistic Nylon	1.7	1.25	1	30	20	15
Midback Task Stool	1.5	1	0.9	25	18	18
Midback Task Stool Ballistic Nylon	1.25	1	0.9	20	18	10
<b>Vetra</b>						
Highback Mesh	–	1.1	–	–	20	–
<b>Wit</b>						
Midback/Highback	N/A	1	N/A	N/A	17	N/A
Midback/Highback Task Stool	N/A	1	N/A	N/A	17	N/A

## COM/COL YARDAGE: MULTIPURPOSE AND SIDE

Combining upholstery is an option on all SitOnIt Seating upholstered products. Below are tables outlining the fabric or vinyl requirements for the entire chair as well as individual pieces. All yardage requirements are quoted in terms of yards for fabric or vinyl and square feet for leather. Please contact Customer Experience for order quantities greater than 10 seats.

	Fabric or Vinyl (In Yardage)			Leather (In Square Feet)		
	Seat and Back	Seat Only	Back Only	Seat and Back	Seat Only	Back Only
<b>Achieve</b>						
Plastic Back	—	1	—	—	17	—
Upholstered Back	1.75	1	1	30	17	15
<b>Anytime</b>						
Multipurpose	1	0.8	0.75	15	10	8
Bar Stool	1	0.8	0.75	15	10	8
<b>Barja</b>						
Multipurpose	1	0.75	—	—	—	—
Bar Stool (Standard Back)	1	0.75	—	—	—	—
Bar Stool (Low Back)	0.75	0.75	—	—	—	—
<b>Cora</b>						
Guest	1.25 yd	0.9 yd	0.75 yd	21 sq ft	14 sq ft	12 sq ft
Midsized	1.75 yd	1 yd	0.95 yd	27 sq ft	17 sq ft	15 sq ft
Bariatric	2 yd	1.25 yd	1.25 yd	30 sq ft	21 sq ft	18 sq ft
<b>Focus Side</b>						
Multipurpose Mesh/Wood	—	1	—	—	17	—
Multipurpose Upholstered	1.25	1	0.75	20	12	10
Counter and Bar Stool Mesh/Wood	—	1	—	—	17	—
Counter and Bar Stool Upholstered	1.25	1	0.75	20	12	10

# COM/COL YARDAGE: MULTIPURPOSE AND SIDE

## Fabric or Vinyl (In Yardage)

## Leather (In Square Feet)

	Seat and Back	Seat Only	Back Only	Seat and Back	Seat Only	Back Only
<b>Freelance</b>						
Multipurpose/Sled	1.25	0.99	1	25	15	—
Multipurpose/Sled Ballistic Nylon	1.15	0.99	0.9	21	15	—
Bariatric (30")	2.25	1	1.35	40	20	—
Bariatric (30") Ballistic Nylon	1.67	1	1	30	20	—
Bariatric (42")	2.5	1.25	1.5	42	25	—
Bariatric (42") Ballistic Nylon	1.75	1.25	1.25	40	25	—
Counter and Bar Stool	1.25	0.99	1	25	15	—
Counter and Bar Stool Ballistic Nylon	1.15	0.9	1	21	15	—
<b>Inflex</b>						
Multipurpose	1	0.85	0.65	15	10	7
Counter and Bar Stool	1	0.85	0.65	15	10	7
<b>Ioniq</b>						
Multipurpose Chair	—	0.75	—	—	7	—
Guest Chair	—	0.75	—	—	7	—
<b>Lumin</b>						
Multipurpose	1	0.85	0.65	15	10	7
Wire Rod	1	0.85	0.65	15	10	7
Counter and Bar Stool	1	0.85	0.65	15	10	7
<b>Mika</b>						
4-Leg	—	0.85	—	—	—	—
Wire Rod	—	0.85	—	—	—	—
<b>Movi</b>						
Nester	—	0.75	—	—	10	—
<b>OnCall</b>						
Multipurpose	0.85	0.8	0.6	14	10	8
Bar Stool	0.85	0.8	0.6	14	10	8

# COM/COL YARDAGE: MULTIPURPOSE AND SIDE

	Fabric or Vinyl (In Yardage)			Leather (In Square Feet)		
	Seat and Back	Seat Only	Back Only	Seat and Back	Seat Only	Back Only
<b>Orbix</b>						
Multipurpose	–	0.75	–	–	–	–
Bar Stool	–	0.75	–	–	–	–
<b>Qwiz</b>						
Nester	1	0.75	–	–	–	–
<b>Relay</b>						
Multipurpose	1	0.75	0.6	15	12	10
Nester	1	0.75	0.6	15	12	10
<b>Rio</b>						
Multipurpose	1	0.85	0.65	15	10	7
Wire Rod	1	0.85	0.65	15	10	7
Counter and Bar Stool	1	0.85	0.65	15	10	7
<b>Rowdy</b>						
Wire Rod	–	0.75	–	–	13	–
<b>Wit Side</b>						
Multipurpose	–	0.75	–	–	10	–

## COM/COL YARDAGE: LOUNGE

Combining upholstery is an option on all SitOnIt Seating upholstered products. Below are tables outlining the fabric or vinyl requirements for the entire chair as well as individual pieces. All yardage requirements are quoted in terms of yards for fabric or vinyl and feet for leather. Please contact Customer Experience for order quantities greater than 10 seats.

	Fabric or Vinyl (In Yardage)			Leather (In Square Feet)		
	Fully Upholstered	Seat Only	Back Only	Fully Upholstered	Seat Only	Back Only
<b>Aviera</b>						
Guest 21"	1.9	1.2	1.1	29.4	—	—
Guest 24"	1.9	1.2	1.6	43.4	—	—
Guest 30"	3.1	1.2	1.9	47.6	—	—
Guest 44"	3.4	1.6	1.9	50.4	—	—
Hip Chair	1.9	1.2	1.1	29.4	—	—
Patient 21"	2.8	1.2	1.9	35	—	—
Patient 24"	2.8	1.2	2.2	43.4	—	—
Patient 30"	3.8	1.2	2.5	50	—	—
Freespan 2-Seat 21"	3.8	1.9	2.1	58	—	—
Freespan 2-Seat 24"	4.3	2.2	3.1	86	—	—
Freespan 3-Seat 21"	5.6	3	3.1	88.2	—	—
Freespan 3-Seat 24"	5.9	3	4.7	93	—	—
Pre-Configured 2-Seat 21"	3.8	1.9	2.1	58	—	—
Pre-Configured 2-Seat 24"	4.3	2.2	3.1	86	—	—
Pre-Configured 3-Seat 21"	5.6	3	3.1	88.2	—	—
Pre-Configured 3-Seat 24"	5.9	3	4.7	93	—	—
Start/Center/End 21"	2.8	1.2	1.9	35	—	—
Start/Center/End 24"	2.8	1.2	2.2	43.4	—	—
Start/Center/End 30"	3.8	1.2	2.5	47.6	—	—
Start/Center/End 44"	3.4	1.6	1.9	50.4	—	—

# COM/COL YARDAGE: LOUNGE

## Fabric or Vinyl (In Yardage)

## Leather (In Square Feet)

	Fully Upholstered	Seat Only	Back Only	Fully Upholstered	Seat Only	Back Only
<b>Cameo</b>						
Single Seat, Dual Arms	5	1.75	1.6	2.25	—	99
Single Seat, Right or Left Arm	4	1.75	1.6	1.25	—	78
Single Seat, Armless	3.25	1.75	1.6	—	—	63
Single Seat, Bench	2	2	—	—	—	36
2-Seater, Dual Arms	7.5	3.25	3	2.25	—	147
2-Seater, Right or Left Arm	6.5	3.25	3	1.25	—	126
2-Seater, Armless	5.75	3.25	3	—	—	115
2-Seater, Bench	3.75	3.75	—	—	—	68
3-Seater, Dual Arms	10.5	5	4.75	2.25	—	170
3-Seater, Right or Left Arm	9	5	4.75	1.25	—	150
3-Seater, Armless	8	5	4.75	—	—	130
3-Seater, Bench	5	5	—	—	—	84

## Composium

Club Chair	5.3	1.9	2.2	3.8	1	83.3
Settee	7.9	3.2	4.1	3.8	1.3	122.5
Sofa	10.5	3.8	5.8	3.8	1.3	163.7
Ottoman	3.2	1.9	—	—	1.9	49
Bench, Single Seat	3.2	1.9	—	—	1.9	49
Bench, Double Seat	3.8	2.9	—	—	2.9	58.8
Bench, Triple Seat	4.4	2.9	—	—	2.9	68.6

## Envoi

Midback Club Chair	3	1	2.5	—	—	50
Highback Club Chair	3.25	1	2.75	—	—	55

*Envoi back yardage includes yardage for arms.*

## Gobi

Club Chair	3.5	2.8	1	—	—	55
------------	-----	-----	---	---	---	----

*Gobi back yardage includes yardage for arms.*

## COM/COL YARDAGE: LOUNGE

	Fabric or Vinyl (In Yardage)			Leather (In Square Feet)		
	Fully Upholstered	Seat Only	Back Only	Fully Upholstered	Seat Only	Back Only
<b>Nano</b>						
Triangle	2	1	—	—	2	—
Diamond	3	1.5	—	—	2	—
Trapezoid	3.5	1.5	—	—	3	—
Boomerang	6.5	3	—	—	4	—
<b>Paséa</b>						
Seat, Single	3	2	1.56	—	—	—
Seat, 1½	4	2.5	1.75	—	—	—
Seat, 90-Degree	5.25	2.75	3	—	—	—
Seat, 120-Degree Inner or Outer	4.38	2.75	2.5	—	—	—
Bench, Single	2	2	—	—	—	—
Bench, 1½	2.5	2.5	—	—	—	—
Bench, Right-Angled or Left-Angled	2.5	2.5	—	—	—	—
Bench, 90° Corner	2.5	2.5	—	—	—	—
Bench, 120° Bench	2.5	2.5	—	—	—	—
Ottoman, Mini Round	1.75	1	—	—	—	—
Ottoman, Mini Square	1.88	1	—	—	—	—
Ottoman, Mini With Table Top	1.25	—	—	—	—	—
Ottoman, Large Round	3.35	1.56	—	—	—	—
Ottoman, Large Square	3.44	1.56	—	—	—	—
Ottoman, Large With Table Top	2	—	—	—	—	—
<b>Visit Modular</b>						
Ottoman	1.88	1.88	—	—	0.94	29.4
Club Chair, Armless	3.5	1.9	2.2	—	—	54.5
Club Chair, Upholstered Left or Right Arm	4.4	1.9	2.2	1.88	—	83.3
Club Chair, Upholstered Left and Right Arms	5.4	1.9	2.2	2.9	—	83.3
Club Chair, Wood Left or Right Arm	3.5	1.9	2.2	—	—	54.5
Club Chair, Wood Left and Right Arms	3.5	1.9	2.2	—	—	54.5

## Pricing

First-time custom stains must be approved before acceptance of an order. A one-time net fee applies if stains are not in our library. Thereafter, a stain-to-match upcharge is applied to each chair.

### TASK AND SIDE CHAIRS

Stain not in our library: \$350 Net

Stain-to-match upcharge: \$55 List

### LOUNGE

Stain not in our library: \$275 Net

Stain-to-match upcharge: \$70 List

## Ordering

When ordering, enter the approved STAIN ID# in the Material section of the Final Price Calculation worksheet or on your purchase order.

## Custom Finish Terms and Conditions

Wood is inherently beautiful because of natural variations in color, grain and texture. There may be minor differences from one chair to the next, even though they are finished at the same time. We cannot guarantee exact matches of grain or natural wood color.

## Approval Process

Since all new stains must be approved before they can be applied to seating or tables, allow extra time for custom finishes. Custom finishes generally require at least one to two weeks to create a matched sample. We will need a signed Approval Form before we can accept your order. We reserve the right to decline the opportunity to match a finish color.

1. Send a 3" x 4" or 4" x 6" sample of the stain, along with the model numbers and options to which the finish will be applied, to:

Customer Experience  
Custom Finish Program  
6415 Katella Avenue  
Cypress, CA 90630

Include dealer name, contact and project reference.

2. Once approved, we will send a finish sample to you along with any caveats that may apply. We will keep an identical sample in our files for future orders. Custom finishes generally require at least a week to create a matched sample.
3. Carefully review the sample. Note the STAIN ID# (example: SM#070214-1); this will be needed for your order. Return the signed approval form to Customer Experience along with your order. We need your approval before we can accept the order, schedule it for production or acknowledge a ship date.
4. Lounge orders using our stain-to-match program will have a lead time of 15 days.



# Chairs and Stools

TASK | LIGHT TASK | EXECUTIVE  
CONFERENCE | COLLABORATIVE

# Statement of Line

TASK | LIGHT TASK | EXECUTIVE CONFERENCE | COLLABORATIVE



**Amplify Mesh**  
Midback Task Chair  
2722 B1 ..... 33



**Amplify Mesh**  
Highback Task Chair  
2723 B1 ..... 33



**Amplify Mesh**  
Midback Task Stool  
2723 B3 S1/S2 ..... 37

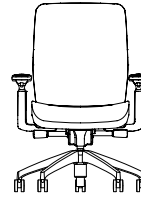

**Amplify Upholstered**  
Highback Task Chair  
2722 B1 ..... 41

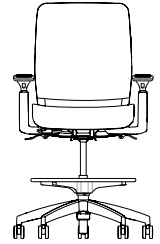

**Amplify Upholstered**  
Highback Task Stool  
2723 B3 S1/S2 ..... 43



**Anytime**  
Light Task Chair  
93T ..... 48



**Anytime**  
Light Task Stool  
93T S1 ..... 48

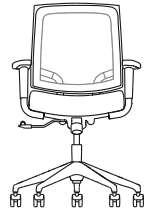

**Focus Mesh**  
Midback Task Chair  
5622 B1 ..... 51

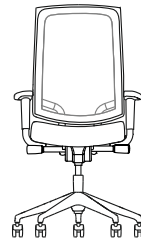

**Focus Mesh**  
Highback Task Chair  
5623 B1 ..... 51

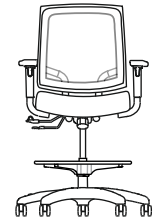

**Focus Mesh**  
Midback Stool  
5622 B1 S1/S2 ..... 56

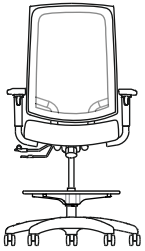

**Focus Mesh**  
Highback Stool  
5623 B1 S1/S2 ..... 56

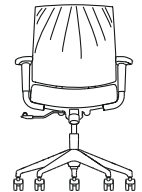

**Focus Upholstered**  
Midback Task Chair  
5622 B4 ..... 60

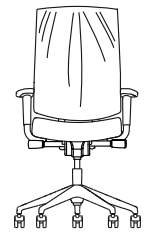

**Focus Upholstered**  
Highback Task Chair  
5623 B4 ..... 60

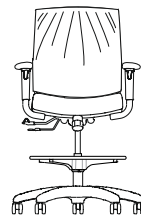

**Focus Upholstered**  
Midback Task Stool  
5622 B4 S1/S2 ..... 65

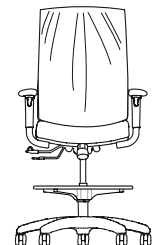

**Focus Upholstered**  
Highback Task Stool  
5623 B4 S1/S2 ..... 65



**Focus 2.0**  
Midback Mesh Task Chair  
1123 BK1 MB ..... 69

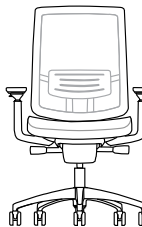

**Focus 2.0**  
Meshback Task Chair  
1123 BK2 MB ..... 69



**Focus 2.0**  
Midback Mesh Task Stool  
1123 BK1 MB S1/S2 ..... 74

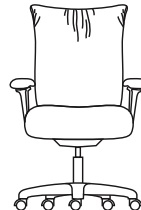

**Glove Active**  
Midback Conference Chair  
7531 ..... 78

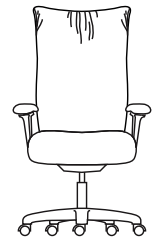

**Glove Active**  
Highback Conference Chair  
7532 ..... 78

# Statement of Line

TASK | LIGHT TASK | EXECUTIVE CONFERENCE | COLLABORATIVE

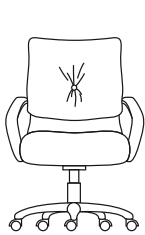

**Glove Executive**  
Midback Conference Chair  
7541..... 82

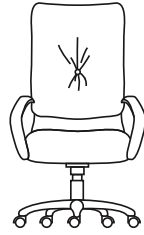

**Glove Executive**  
Highback Executive Chair  
7542..... 82

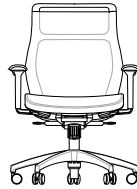

**Hexy**  
Midback Mesh Task Chair  
1203 BK1 MB ..... 85



**Hexy**  
Highback Mesh Task Chair  
1203 BK2 MB ..... 85



**Hexy**  
Midback Mesh Task Stool  
1203 BK1 MB S1/S2..... 89



**InFlex**  
Light Task Chair  
973..... 93

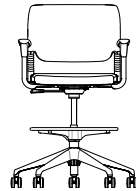

**InFlex**  
Light Task Stool  
973B S1/S2 ..... 93

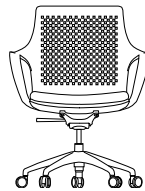

**Ioniq**  
Collaborative Chair  
1152 FT3..... 97



**Knack**  
Midback Task Chair  
3323..... 100



**Knack**  
Midback Task Stool  
3323 S1/S2..... 104

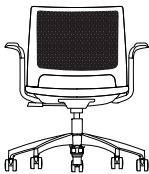

**Lumin**  
Light Task Chair  
1012 FT3..... 107



**Lumin**  
Light Task Stool  
1012 FT3 S21/S22..... 107



**Mavic**  
Collaborative Chair  
1113 ..... 111



**Movu**  
Light Task Chair  
1062 FT3..... 114



**Movu**  
Light Task Stool  
1062 FT3 S21/S22..... 114



**Non-Stop**  
Heavy Duty Task Chair  
673..... 117



**Non-Stop**  
Heavy Duty Task Stool  
671 B2 ..... 120



**Novo**  
Midback Mesh Task Chair  
1033 BK1 ..... 123

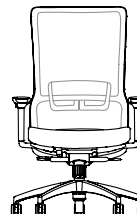

**Novo**  
Highback Mesh Task Chair  
1033 BK2..... 123

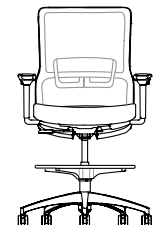

**Novo**  
Midback Mesh Task Stool  
1033 BK1 S1..... 128

# Statement of Line

TASK | LIGHT TASK | EXECUTIVE CONFERENCE | COLLABORATIVE

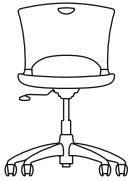

**OnCall**  
Light Task Chair  
90T..... 132



**OnCall**  
Light Task Stool  
90TB S1/S2 ..... 132



**Orbix**  
Light Task Chair  
1132 FT3 CH1..... 136



**Orbix**  
Light Task Stool  
1132 FT3 S21/S22..... 136

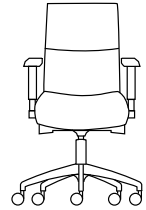

**Prava**  
Midback Conference Chair  
6422..... 139

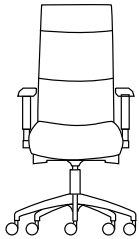

**Prava**  
Highback Conference Chair  
6423..... 139

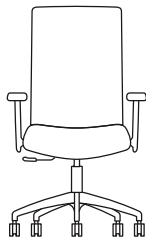

**ReAlign**  
Midback Task Chair  
681..... 143



**ReAlign**  
Highback Task Chair  
682..... 143

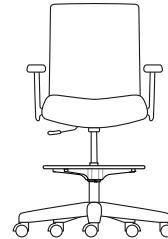

**ReAlign**  
Midback Task Stool  
681B ..... 147

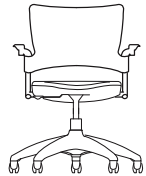

**Relay**  
Light Task Chair  
94T..... 150

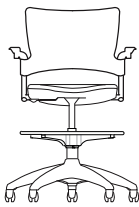

**Relay**  
Light Task Stool  
94B S1/S2 ..... 150

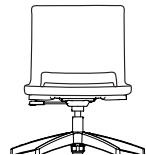

**Rio**  
Light Task Chair  
1052 FT3..... 154

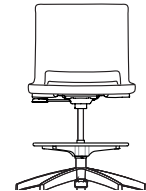

**Rio**  
Light Task Chair  
1052 FT3 S21/S22..... 154

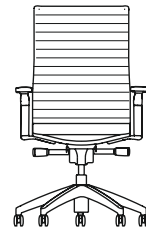

**Sona**  
Knit Back Conference Chair  
5723 B7 ..... 158

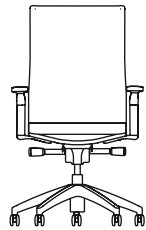

**Sona**  
Upholstered Conference Chair  
5723 B8 ..... 158

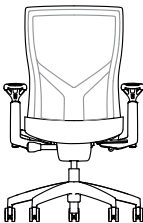

**Torsa**  
Mesh Back Conference Chair  
5723 B8 ..... 162



**TR2**  
Midback Task Chair  
40..... 166



**TR2**  
Highback Executive Chair  
40E ..... 166



**TR2**  
Midback Task Stool  
40 S1/S2 ..... 170

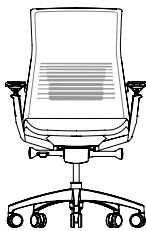

**Vectra**  
Highback Mesh Task Chair  
1073 BK2 MB ..... 174

# Statement of Line

TASK | LIGHT TASK | EXECUTIVE CONFERENCE | COLLABORATIVE

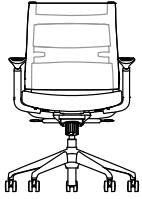

**Wit Mesh**  
Midback Task Chair  
2222 B1 ..... 178

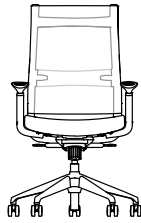

**Wit Mesh**  
Highback Task Chair  
2223 B1 ..... 178

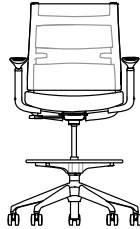

**Wit Mesh**  
Midback Task Stool  
2222 B1 S1/S2 ..... 182

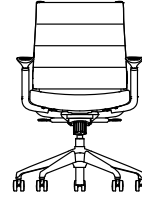

**Wit Thintex**  
Midback Task Chair  
2222 B9 ..... 186

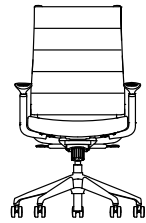

**Wit Thintex**  
Highback Task Chair  
2223 B9 ..... 186

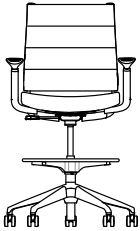

**Wit Thintex**  
Midback Task Stool  
2222 B9 S1/S2 ..... 190

# Amplify

## MESH BACK TASK CHAIR

### *The power of more.*

The sleek, aerodynamic design gives Amplify™ power with the appearance of smart, no-nonsense efficiency and comfort. The supportive mesh back with adjustable lumbar support, three application-specific arm types and waterfall seat add great ergonomics and comfort to the equation. The eye-catching lumbar bands, curvaceous profile and soft, textured arm pads make this a chair that delivers style as well as substance.



*Best*

**EFFECTIVE DECEMBER 1, 2021**

### Featured Models

#### **GOOD :: \$673**

Midback, black frame, swivel-tilt mechanism, fixed arms, black nylon base, carpet casters, grade 1 textile

#### **BETTER :: \$761**

Highback, black frame, enhanced synchro mechanism, height-adjustable arms, black nylon base, carpet casters, grade 1 textile

#### **BEST :: \$905**

Highback, fog frame, enhanced synchro mechanism with seat-depth adjustment, multi-adjustable arms, fog nylon base, carpet casters, grade 1 textile

## MESH BACK TASK CHAIR

### Features

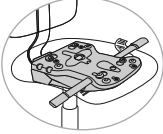
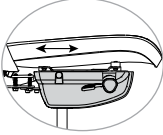

- Midback or highback task chair
- Aerodynamic design
- Multiple frame, back support and arm color choices
- Adjustable lumbar support
- 10 bleach-cleanable mesh back colors
- Contrast stitching in 10 thread colors
- Enhanced synchro or swivel-tilt
- Waterfall seat
- Three arm styles with textured arm pads
- Black, fog or polished aluminum base
- Optional seat-depth adjustment
- Standard 300 lb weight capacity warranty;  
Heavy Duty Series 400 lb weight capacity warranty

### 3. Mechanism

Mechanism Style	Code	Price	
Swivel-Tilt	T	-\$50	
Enhanced Synchro	Y	+\$0	
Enhanced Synchro With Seat-Depth Adjustment	Y E3	+\$79	

Seat-depth adjustment (E3) available with enhanced synchro (Y) mechanism only.

### 1. Back

Back Size and Style	Code	Price	
Midback Mesh With Adjustable Lumbar Support	2722 B1	\$733	
Highback Mesh With Adjustable Lumbar Support	2723 B1	\$761	

### 2. Heavy Duty

Heavy Duty Series	Code	Price	
Large and Tall (Black Highback Frame With Enhanced Synchro Y Mechanism and Sport Height-Adjustable Arms)	LT	+\$250	

See the Heavy Duty Guide on page 536 for additional LT and HD options.





Better

## 4. Frame

Frame Color	Code	Price	
Black	FC1	+ \$0	
Fog	FC13	+ \$35	

Frame color includes base, lumbar support band and arms.

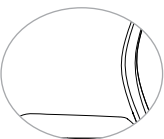
## 5. Arms

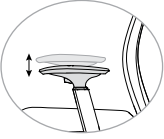
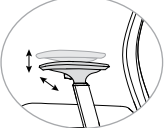
Arm Style	Code	Price	
Armless	A0	- \$48	
Fixed Polyurethane	A140	- \$10	
Height-Adjustable	A141	+ \$0	
Multi-Adjustable (Height/Width)	A142	+ \$30	

Arm color will match the frame. Arm pads are black except fixed polyurethane arm (A140) which matches frame color.

## 6. Base

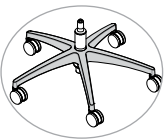
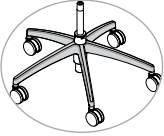
Base Color and Material	Code	Price	
Black Nylon Base (For Black Frame FC1)	B17	+ \$0	
Fog Nylon Base (For Fog Frame FC13)	B21	+ \$0	
Polished Aluminum Base	B18	+ \$113	

## MESH BACK TASK CHAIR

## 6. Base (Cont.)

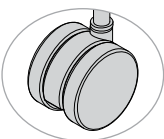
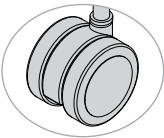
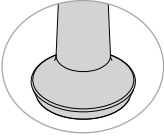
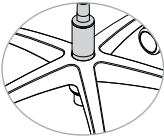
Casters or Glides	Code	Price	
<b>Casters</b>			
Black Carpet Casters	C16	+ \$0	
Black Hard Floor and Carpet Casters	C17	+ \$40	
<b>Glides</b>			
Glides for Task Chairs	C3	+ \$30	
<b>Cylinder Height</b>			
Standard Cylinder	S0	+ \$0	
Higher Cylinder	S13	+ \$0	

Nylon bases pair only with their corresponding frame color. Polished aluminum base (B18) can be used with all frame colors.

## 7. Material

Protection	Code	Price	
<b>Fire Retardency</b>			
CAL 133, Fabric, Quantities 1-49	133F	+ \$99	
CAL 133, Fabric, Quantities 50+	133F5	+ \$55	
CAL 133, Leather, Any Quantity	133L	+ \$119	
<b>Mesh Color</b>			
Apple	MC31	+ \$0	
Aqua	MC30	+ \$0	
Desert	MC9	+ \$0	
Electric Blue	MC24	+ \$0	
Fire	MC10	+ \$0	
Fog	MC7	+ \$0	
Navy	MC8	+ \$0	
Nickel	MC6	+ \$0	
Onyx	MC5	+ \$0	
Tangerine	MC28	+ \$0	



## MESH BACK TASK CHAIR

### 7. Material (Cont.)

Seat Textile	Code	Price	
Fabric/Vinyl Grade 1	FG1/VG1	+ \$0	
COM	COM	+ \$26	
Fabric/Vinyl Grade 2	FG2/VG2	+ \$26	
Fabric/Vinyl Grade 3	FG3/VG3	+ \$60	
Fabric/Vinyl Grade 4	FG4/VG4	+ \$116	
Fabric/Vinyl Grade 5	FG5/VG5	+ \$172	
Fabric/Vinyl Grade 6	FG6/VG6	+ \$213	
Fabric/Vinyl Grade 7	FG7/VG7	+ \$254	
Leather Grade 1	LG1	+ \$300	
COL	COL	+ \$380	
Leather Grade 2	LG2	+ \$380	
Leather Grade 3	LG3	+ \$480	
Contrast Stitching	Code	Price	
No Contrast Stitching	TC0	+ \$0	
Apple Thread	TC3	+ \$0	
Desert Thread	TC9	+ \$0	
Electric Blue Thread	TC4	+ \$0	
Fire Thread	TC10	+ \$0	
Fog Thread	TC7	+ \$0	
Lemon Thread	TC2	+ \$0	
Navy Thread	TC8	+ \$0	
Nickel Thread	TC6	+ \$0	
Onyx Thread	TC5	+ \$0	
White Thread	TC1	+ \$0	

Contrast stitching available only for SitOnIt Seating carded fabrics in solid colors.

Please reference the Textile Reference Guide for pricing on fabric over grade 7 and leather over grade 3. Additional CAL 133 information can be found on page 10.

### 8. Packaging

Packaging	Code	Price	
Knocked Down	KD	+ \$0	
Back Attached to Seat, Base Separate	UC	+ \$80	
Fully Assembled in Carton	AC	+ \$200	

### SPECIFICATIONS

	2722 Midback Mesh Task Chair	2723 Highback Mesh Task Chair	2723 LT Large and Tall Task Chair
<b>Dimensions</b>			
Overall Width Without Arms	26"	26"	26"
Overall Width With Arms	27.75"-28.25"	27.75"-28.25"	29"
Overall Depth	24.5"	24.5"	27.75"
Overall Height	40"	43"	42"
Seat Width	19.25"	19.25"	22"
Seat Depth	17.5"-19.75"	17.5"-19.75"	17.5"
Seat Height With Standard Base	16.5"-20.12" (T) 16.5"-20.35" (Y)	16.5"-20.12" (T) 16.5"-20.35" (Y)	N/A 17.5"-21.5" (Y)
Seat Height With Higher Cylinder	17.5"-21.87" (T) 18"-22.5" (Y)	18"-23" (T) 18"-22.5" (Y)	N/A 18"-22.5" (Y)
Back Width	19.5"	19.5"	19.5"
Back Height	20.37"	23.37"	22"
<b>Materials</b>			
COM	1 yd	1 yd	1.15 yd
COL	17 sq ft	17 sq ft	18 sq ft
<b>Weight and Capacity</b>			
Weight Armless	32 lb	34 lb	44 lb
Weight With Arms	37 lb	39 lb	50 lb
Weight Capacity Warranty	300 lb	300 lb	400 lb

Swivel-tilt mechanism (T). Enhanced synchro mechanism (Y).

# Amplify

## MESH BACK TASK STOOL

### *The power of more.*

The sleek, aerodynamic design gives Amplify™ power with the appearance of smart, no-nonsense efficiency and comfort. The supportive mesh back with adjustable lumbar support, three application-specific arm types and waterfall seat add great ergonomics and comfort to the equation. The eye-catching lumbar bands, curvaceous profile and soft, textured arm pads make this a stool that delivers style as well as substance.



EFFECTIVE DECEMBER 1, 2021

### Featured Models

#### **GOOD :: \$762**

Midback mesh, basic mechanism, black frame, armless, black nylon base, carpet casters, grade 1 textile

#### **BETTER :: \$810**

Midback mesh, basic mechanism, black frame, height-adjustable arms, black nylon base, carpet casters, grade 1 textile

#### **BEST :: \$899**

Midback mesh, basic mechanism, fog frame, multi-adjustable arms, extended stool kit, fog nylon base, carpet casters, grade 1 textile

## Features

- Midback task stool
- Aerodynamic design
- Multiple frame, back support and arm color choices
- Adjustable lumbar support
- 10 bleach-cleanable mesh back colors
- Contrast stitching in 10 thread colors
- Waterfall seat
- Three arm styles with textured arm pads
- Black, fog or polished aluminum base
- Standard 300 lb weight capacity warranty

### 1. Back

Back Size and Style	Code	Price	
Midback Mesh Task Stool With Adjustable Lumbar Support	2722 B1	\$810	

### 2. Mechanism

Mechanism Style	Code	Price	
Basic (Swivel Only)	B	+ \$0	



### 3. Frame

Frame Color	Code	Price	
Black	FC1	+ \$0	
Fog	FC13	+ \$35	

Frame color includes base, lumbar support band and arms.

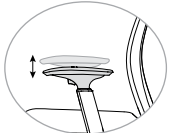
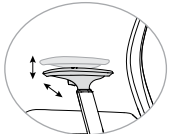

## MESH BACK TASK STOOL

### 4. Arms

Arm Style	Code	Price	
Armless	A0	- \$48	
Fixed Polyurethane	A140	- \$10	
Height-Adjustable	A141	+ \$0	
Multi-Adjustable (Height/Width)	A142	+ \$30	

Arm color will match the frame. Arm pads are black except fixed polyurethane arm which matches frame color.

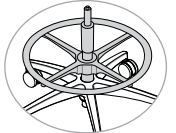
### 5. Base

Base	Code	Price	
Stool Kit	S1	+ \$0	
Extended Stool Kit	S2	+ \$24	
Base Color and Material	Code	Price	
Black Nylon Base (For Black Frame – FC1)	B17	+ \$0	
Fog Nylon Base (For Fog Frame – FC13)	B21	+ \$0	
Polished Aluminum Base	B18	+ \$113	

Nylon bases pair only with their corresponding frame color. Polished aluminum base (B18) can be used with all frame colors.

## 5. Base (Cont.)

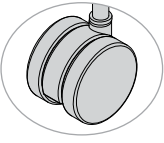
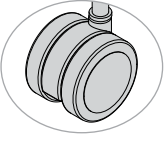
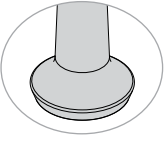
Casters or Glides	Code	Price	
<b>Casters</b>			
Black Carpet Casters	C16	+ \$0	
Black Hard Floor and Carpet Casters	C17	+ \$40	
<b>Glides</b>			
Glides for Task Chairs	C3	+ \$30	

## 6. Material

Protection	Code	Price	
<b>Fire Retardency</b>			
CAL 133, Fabric, Quantities 1-49	133F	+ \$99	
CAL 133, Fabric, Quantities 50+	133F5	+ \$55	
CAL 133, Leather, Any Quantity	133L	+ \$119	
Mesh Color	Code	Price	
Apple	MC31	+ \$0	
Aqua	MC30	+ \$0	
Desert	MC9	+ \$0	
Electric Blue	MC24	+ \$0	
Fire	MC10	+ \$0	
Fog	MC7	+ \$0	
Navy	MC8	+ \$0	
Nickel	MC6	+ \$0	
Onyx	MC5	+ \$0	
Tangerine	MC28	+ \$0	

## MESH BACK TASK STOOL

## 6. Material (Cont.)

Seat Textile	Code	Price	
Fabric/Vinyl Grade 1	FG1/VG1	+ \$0	
COM	COM	+ \$26	
Fabric/Vinyl Grade 2	FG2/VG2	+ \$26	
Fabric/Vinyl Grade 3	FG3/VG3	+ \$60	
Fabric/Vinyl Grade 4	FG4/VG4	+ \$116	
Fabric/Vinyl Grade 5	FG5/VG5	+ \$172	
Fabric/Vinyl Grade 6	FG6/VG6	+ \$213	
Fabric/Vinyl Grade 7	FG7/VG7	+ \$254	
Leather Grade 1	LG1	+ \$300	
COL	COL	+ \$380	
Leather Grade 2	LG2	+ \$380	
Leather Grade 3	LG3	+ \$480	
Contrast Stitching	Code	Price	
No Contrast Stitching	TC0	+ \$0	
Apple Thread	TC3	+ \$0	
Desert Thread	TC9	+ \$0	
Electric Blue Thread	TC4	+ \$0	
Fire Thread	TC10	+ \$0	
Fog Thread	TC7	+ \$0	
Lemon Thread	TC2	+ \$0	
Navy Thread	TC8	+ \$0	
Nickel Thread	TC6	+ \$0	
Onyx Thread	TC5	+ \$0	
White Thread	TC1	+ \$0	

Contrast stitching available only for SitOnIt Seating carded fabrics in solid colors. Please reference the *Textile Reference Guide* for pricing on fabric over grade 7 and leather over grade 3. Additional CAL 133 information can be found on page 10.

## 7. Packaging

Packaging	Code	Price	
Knocked Down	KD	+ \$0	
Back Attached to Seat, Base Separate	UC	+ \$80	
Fully Assembled in Carton	AC	+ \$200	

## MESH BACK TASK STOOL

### SPECIFICATIONS

	2722 B1 S1 Task Stool	2722 B1 S2 Extended Task Stool
<b>Dimensions</b>		
Overall Width Armless	24.5"	24.5"
Overall Width With Arms	27.75"-28.25"	27.75"-28.25"
Overall Depth	24.5"	24.5"
Overall Height	39"-46.5"	43.75"-53.38"
Seat Width	19.25"	19.25"
Seat Depth	17.75"	17.75"
Seat Height	21.5"-29.5"	25"-35"
Back Width	19.5"	19.5"
Back Height	20.37"	20.37"
<b>Materials</b>		
COM	1 yd	1 yd
COL	17 sq ft	17 sq ft
<b>Weight and Capacity</b>		
Weight Armless	34 lb	35 lb
Weight With Arms	39.5 lb	40 lb
Weight Capacity	300 lb	300 lb



# Amplify

UPHOLSTERED BACK TASK CHAIR

## *The power of more.*

In keeping with the aerodynamic design of the well-regarded Amplify™ mesh model, the Amplify upholstered chair's sleek and slender profile proves that this is a chair that delivers style as well as substance.



EFFECTIVE DECEMBER 1, 2021

## Featured Models

### **GOOD :: \$756**

Highback upholstered, black frame, swivel-tilt mechanism, fixed arms, black nylon base, carpet casters, grade 1 textile

### **BETTER :: \$816**

Highback upholstered, black frame, enhanced synchro mechanism, height-adjustable arms, black nylon base, carpet casters, grade 1 textile

### **BEST :: \$960**

Highback upholstered, fog frame, enhanced synchro mechanism with seat-depth adjustment, multi-adjustable arms, fog nylon base, carpet casters, grade 1 textile

### Features

- Highback task chair
- Aerodynamic design
- Multiple frame, back support and arm color choices
- Adjustable lumbar support
- Enhanced synchro or swivel-tilt
- Waterfall seat
- Three arm styles with textured arm pads
- Black, fog, silver or polished aluminum base
- Optional seat-depth adjustment
- Standard 300 lb weight capacity warranty;  
Heavy Duty Series 400 lb weight capacity warranty

### 3. Mechanism

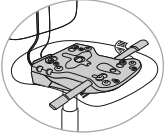
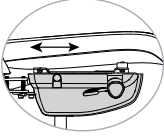
Mechanism Style	Code	Price	
Swivel-Tilt	T	- \$50	
Enhanced Synchro	Y	+ \$0	
Enhanced Synchro With Seat-Depth Adjustment	Y E3	+ \$79	

Seat-depth adjustment (E3) is not available on swivel-tilt (T) mechanism.

### 1. Back

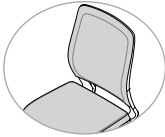
Back Size and Style	Code	Price	
Highback Upholstered With Dynamic Lumbar	2723 B3	\$816	

### 2. Heavy Duty

Heavy Duty Series	Code	Price	
Large and Tall (Black Highback Frame With Enhanced Synchro Y Mechanism and Sport Height-Adjustable Arms)	LT	+ \$250	

See page 536 for additional LT and HD options.





## 4. Frame

Frame Color	Code	Price	
Black, Single-Color Nylon Frame	FC1	+ \$0	
Fog, Single-Color Nylon Frame	FC13	+ \$35	
Fog With Silver, Two-Color Nylon Frame	FC14	+ \$35	

Single-color nylon frame includes base, back support and arms.

Two-color nylon frame includes fog frame with silver back support and silver base. Adjustable arms are silver. Fixed arms are fog.

## 5. Arms

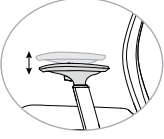
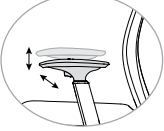
Arm Style	Code	Price	
Armless	A0	- \$48	
Fixed Polyurethane	A140	- \$10	
Height-Adjustable	A141	+ \$0	
Multi-Adjustable (Height/Width)	A142	+ \$30	

Arm color will match the frame. Arm pads are black except fixed polyurethane arm which matches frame color.

## 6. Base

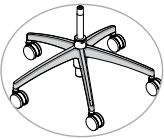
Base Color and Material	Code	Price	
Black Nylon Base (For Black Frame FC1)	B17	+ \$0	
Fog Nylon Base (For Fog Frame FC13)	B21	+ \$0	
Silver Nylon Base (For Fog Frame With Silver FC14)	B22	+ \$0	
Polished Aluminum Base	B18	+ \$113	

Nylon bases pair only with their corresponding frame color. Polished aluminum base (B18) can be used with all frame colors.

## UPHOLSTERED BACK TASK CHAIR

## 6. Base (Cont.)

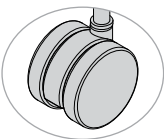
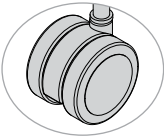
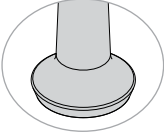
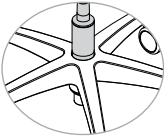
Casters or Glides	Code	Price	
<b>Casters</b>			
Black Carpet Casters	C16	+ \$0	
Black Hard Floor and Carpet Casters	C17	+ \$40	
<b>Glides</b>			
Glides for Task Chairs	C3	+ \$30	
<b>Cylinder Height</b>			
Standard Cylinder	S0	+ \$0	
Higher Cylinder	S13	+ \$0	
<b>7. Material</b>			
<b>Protection</b>			
<b>Fire Retardency</b>			
CAL 133, Fabric, Quantities 1-49	133F	+ \$99	
CAL 133, Fabric, Quantities 50+	133F5	+ \$55	
CAL 133, Leather, Any Quantity	133L	+ \$119	



## UPHOLSTERED BACK TASK CHAIR

### 7. Material (Cont.)

Seat and Back Textile	Code	Price
Fabric/Vinyl Grade 1	FG1/VG1	+ \$0
COM	COM	+ \$34
Fabric/Vinyl Grade 2	FG2/VG2	+ \$34
Fabric/Vinyl Grade 3	FG3/VG3	+ \$74
Fabric/Vinyl Grade 4	FG4/VG4	+ \$121
Fabric/Vinyl Grade 5	FG5/VG5	+ \$174
Fabric/Vinyl Grade 6	FG6/VG6	+ \$235
Fabric/Vinyl Grade 7	FG7/VG7	+ \$296
Leather Grade 1	LG1	+ \$320
COL	COL	+ \$420
Leather Grade 2	LG2	+ \$420
Leather Grade 3	LG3	+ \$540

Please reference the *Textile Reference Guide* for pricing on fabric over grade 7 and leather over grade 3. Additional CAL 133 information can be found on page 10.



Good

### 8. Packaging

Packaging	Code	Price
Knocked Down	KD	+ \$0
Back Attached to Seat, Base Separate	UC	+ \$80
Fully Assembled in Carton	AC	+ \$200

### SPECIFICATIONS

	2723 B3 Highback Upholstered Task Chair	2723 B3 LT Large and Tall Upholstered Task Chair
<b>Dimensions</b>		
Overall Width Armless	26"	26"
Overall Width With Arms	27.75"	27.75"
Overall Depth	24.5"	27.75"
Overall Height	42"	42"
Seat Width	19.25"	22"
Seat Depth	17.5"-19.75"	17.5"-19.75"
Seat Height With Standard Cylinder (S0)	16.5"-20.12" (T) 16.5"-20.35" (Y)	N/A 17.5"-21.5" (Y)
Seat Height With Higher Cylinder (S13)	17.5"-21.87" (T) 18"-22.5" (Y)	N/A 18"-23" (Y)
Back Width	18.5"	18.5"
Back Height	22"	22"
<b>Materials</b>		
COM	1.25 yd	1.25 yd
COL	23 sq ft	23 sq ft
<b>Weight and Capacity</b>		
Weight Armless	35 lb	45 lb
Weight With Arms	40 lb	51 lb
Weight Capacity	300 lb	400 lb

Swivel tilt mechanism (T). Enhanced synchro mechanism (Y).

# Amplify

## UPHOLSTERED BACK TASK STOOL

### *The power of more.*

In keeping with the aerodynamic design of the well-regarded Amplify™ mesh model, the Amplify upholstered chair's sleek and slender profile proves that this is a stool that delivers style as well as substance.



EFFECTIVE DECEMBER 1, 2021

### Featured Models

#### **GOOD :: \$817**

Highback upholstered, basic mechanism, black frame, armless, black nylon base, carpet casters, grade 1 textile

#### **BETTER :: \$865**

Highback upholstered, basic mechanism, black frame, height-adjustable arms, black nylon base, black carpet casters, grade 1 textile

#### **BEST :: \$954**

Highback upholstered, basic mechanism, fog frame, multi-adjustable arms, extended stool kit, fog nylon base, carpet casters, grade 1 textile

## Features

- Highback task stool
- Aerodynamic design
- Multiple frame, back support and arm color choices
- Adjustable lumbar support
- Waterfall seat
- Three arm styles with textured arm pads
- Black, fog or polished aluminum base
- Standard 300 lb weight capacity warranty

### 1. Back

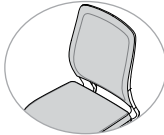
Back Size and Style	Code	Price	
Highback Upholstered Task Stool With Dynamic Lumbar	2723 B3	\$865	

### 2. Mechanism

Mechanism Style	Code	Price	
Basic (Swivel Only)	B	+ \$0	

### 3. Frame



Frame Color	Code	Price	
Black, Single-Color Nylon Frame	FC1	+ \$0	
Fog, Single-Color Nylon Frame	FC13	+ \$35	
Fog With Silver, Two-Color Nylon Frame	FC14	+ \$35	

Single-color frame includes base, lumbar support band and arms.

Two-color frame includes fog frame with silver back support and silver base. Adjustable arms are silver. Fixed arms are fog.

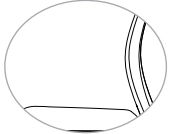

## UPHOLSTERED BACK TASK STOOL

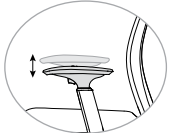
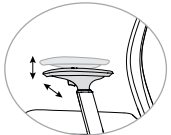
### 4. Arms

Arm Style	Code	Price	
Armless	A0	- \$48	
Fixed Polyurethane	A140	- \$10	
Height-Adjustable	A141	+ \$0	
Multi-Adjustable (Height/Width)	A142	+ \$30	

Arm color will match the frame. Arm pads are black except fixed polyurethane arm (A140) which matches frame color.

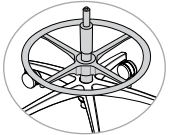
### 5. Base

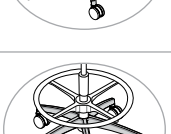
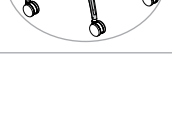
Base	Code	Price	
Stool Kit	S1	+ \$0	
Extended Stool Kit	S2	+ \$24	
Base Color and Material	Code	Price	
Black Nylon Base (For Black Frame FC1)	B17	+ \$0	
Fog Nylon Base (For Fog Frame FC13)	B21	+ \$0	
Silver Nylon Base (For Fog Frame With Silver FC14)	B22	+ \$0	
Polished Aluminum Base	B18	+ \$113	

## 5. Base (Cont.)

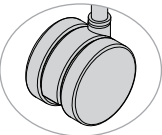
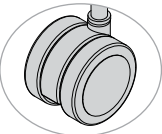
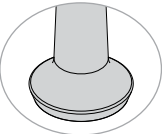
Casters or Glides	Code	Price	
<b>Casters</b>			
Black Carpet Casters	C16	+ \$0	
Black Hard Floor and Carpet Casters	C17	+ \$40	
<b>Glides</b>			
Glides for Task Chairs	C3	+ \$30	

Nylon bases pair only with their corresponding frame color. Polished aluminum base (B18) can be used with all frame colors.

## 6. Material

Protection	Code	Price	
CAL 133, Fabric, Quantities 1-49	133F	+ \$99	
CAL 133, Fabric, Quantities 50+	133F5	+ \$55	
CAL 133, Leather, Any Quantity	133L	+ \$119	
Seat and Back Textile	Code	Price	
Fabric/Vinyl Grade 1	FG1/VG1	+ \$0	
COM	COM	+ \$34	
Fabric/Vinyl Grade 2	FG2/VG2	+ \$34	
Fabric/Vinyl Grade 3	FG3/VG3	+ \$74	
Fabric/Vinyl Grade 4	FG4/VG4	+ \$121	
Fabric/Vinyl Grade 5	FG5/VG5	+ \$174	
Fabric/Vinyl Grade 6	FG6/VG6	+ \$235	
Fabric/Vinyl Grade 7	FG7/VG7	+ \$296	
Leather Grade 1	LG1	+ \$320	
COL	COL	+ \$420	
Leather Grade 2	LG2	+ \$420	
Leather Grade 3	LG3	+ \$540	

Please reference the Textile Reference Guide for pricing on fabric over grade 7 and leather over grade 3. Additional CAL 133 information can be found on page 10.

## UPHOLSTERED BACK TASK STOOL

## 7. Packaging

Protection	Code	Price	
Knocked Down	KD	+ \$0	
Back Attached to Seat, Base Separate	UC	+ \$80	
Fully Assembled in Carton	AC	+ \$200	

## SPECIFICATIONS

	2723 B3 S1 Task Stool	2723 B3 S2 Extended Task Stool
<b>Dimensions</b>		
Overall Width Armless	24.5"	24.5"
Overall Width With Arms	27.75"-28.25"	27.75"-28.25"
Overall Depth	24.5"	24.5"
Overall Height	40.75"-48.25"	45.5"-55.13"
Seat Width	19.25"	19.25"
Seat Depth	17.75"	17.75"
Seat Height	21.5"-29.5"	25"-35"
Back Width	18.5"	18.5"
Back Height	22"	22"
<b>Materials</b>		
COM	1.25 yd	1.25 yd
COL	23 sq ft	23 sq ft
<b>Weight and Capacity</b>		
Weight Armless	35.5 lb	36 lb
Weight With Arms	40.5 lb	41 lb
Weight Capacity Warranty	300 lb	300 lb

# Anytime

LIGHT TASK CHAIR AND TASK STOOL

*Grab and go.  
Anywhere.*

The Anytime™ light task chair and stool pair perfectly with the Anytime side chair to make a complete set. Featuring the versatility that is the signature of the collection along with a perforated shell and a built-in pull handle, Anytime makes any office, meeting or training room a work space.



**EFFECTIVE DECEMBER 1, 2021**

## Featured Models

### **GOOD :: \$434**

All plastic, basic mechanism, armless, carpet casters

### **BETTER :: \$542**

Plastic back and upholstered seat, swivel-tilt mechanism, armless, carpet casters



### **BEST :: \$658**

Fully upholstered, swivel-tilt mechanism, fixed arms, carpet casters

## Features

- Light task chair and light task stool
- Fully upholstered, upholstered seat only or plastic
- Nine plastic colors
- Perforated shell provides ventilation
- Built-in pull handle
- Black or silver tubular frame
- 250 lb weight capacity
- Complements Anytime multipurpose chair and bar stool; see page 190

### 1. Back

Seat and Back Style	Code	Price	
Plastic	No Code	\$484	
Upholstered Seat Only	US	\$542	
Upholstered Seat and Back	UP	\$600	

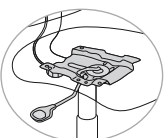
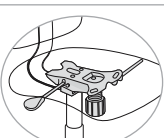

### 2. Mechanism

Mechanism Style	Code	Price	
Basic (Swivel Only)	B	- \$50	
Swivel-Tilt	T	+ \$0	



Swivel-tilt mechanism (T) is not available for task stool (S1) or extended task stool (S2).

## LIGHT TASK CHAIR AND TASK STOOL

### 3. Frame

Frame Type	Code	Price	
Task Chair	93T	+ \$0	
Task Stool	93T S1	+ \$132	
Extended Task Stool	93T S2	+ \$156	

### 4. Arms

Arm Style	Code	Price	
Armless	A0	+ \$0	
Fixed Loop Arms	A48	+ \$58	

### 5. Base

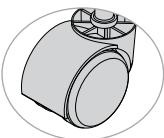
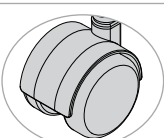
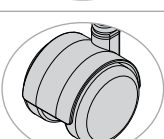
Casters and Glides	Code	Price	
<b>Casters</b>			
Carpet Casters	C6	+ \$0	
Hard Floor and Carpet Casters	C1	+ \$40	
Self-Locking Carpet Casters	C2	+ \$30	
Self-Locking Hard Floor and Carpet Casters	C7	+ \$61	

## 5. Base

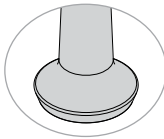
Casters and Glides	Code	Price	
Glides			
Glides for Task Chairs	C3	+ \$30	

Self-locking casters (C2/C7) lock only when not in use.

## 6. Material

Protection	Code	Price	
Fire Retardancy			
CAL 133, Fabric, Quantities 1-49	133F	+ \$99	
CAL 133, Fabric, Quantities 50+	133F5	+ \$55	
CAL 133, Plastic, Any Quantity	133P	+ \$45	
Shell Color	Code	Price	
Arctic	SC21	+ \$0	
Black	SC1	+ \$0	
Chocolate	SC4	+ \$0	
Lagoon	SC15	+ \$0	
Latte	SC20	+ \$0	
Navy	SC5	+ \$0	
Red	SC19	+ \$0	
Slate	SC8	+ \$0	
Sterling	SC18	+ \$0	
Textile	Code	Price	
Seat Textile Only (For US)			
Fabric/Vinyl Grade 1	FG1/VG1	+ \$0	
COM	COM	+ \$22	
Fabric/Vinyl Grade 2	FG2/VG2	+ \$22	
Fabric/Vinyl Grade 3	FG3/VG3	+ \$45	
Fabric/Vinyl Grade 4	FG4/VG4	+ \$77	
Fabric/Vinyl Grade 5	FG5/VG5	+ \$116	
Fabric/Vinyl Grade 6	FG6/VG6	+ \$159	
Fabric/Vinyl Grade 7	FG7/VG7	+ \$200	

## LIGHT TASK CHAIR AND TASK STOOL

## 6. Material

Textile	Code	Price	
Seat and Back Textile (For UP)			
Fabric/Vinyl Grade 1	FG1/VG1	+ \$0	
COM	COM	+ \$34	
Fabric/Vinyl Grade 2	FG2/VG2	+ \$34	
Fabric/Vinyl Grade 3	FG3/VG3	+ \$74	
Fabric/Vinyl Grade 4	FG4/VG4	+ \$121	
Fabric/Vinyl Grade 5	FG5/VG5	+ \$174	
Fabric/Vinyl Grade 6	FG6/VG6	+ \$235	
Fabric/Vinyl Grade 7	FG7/VG7	+ \$296	

Please reference the Textile Reference Guide for pricing on fabric over grade 7. Additional CAL 133 information can be found on page 10.

## 7. Packaging

Packaging	Code	Price	
Back Attached to Seat, Base Separate	UC	+ \$0	
Fully Assembled in a Carton	AC	+ \$120	

## SPECIFICATIONS

	93T Task	93T S1 Task Stool	93T S2 Extended Task Stool
Dimensions			
Overall Width Armless	26"	26"	26"
Overall Width With Arms	26.5"	26.5"	26.5"
Overall Depth	26"	26"	26"
Overall Height	35.5"	39"	43"
Seat Width	19"	19"	19"
Seat Depth	18"	18"	18"
Seat Height	16"-21"	16.6"-27"	23.5"-33.5"
Back Width	21.5"	21.5"	21.5"
Back Height	14.5"	14.5"	14.5"
Materials			
COM	0.8 yd (US) 1 yd (UP)	0.8 yd (US) 1 yd (UP)	0.8 yd (US) 1 yd (UP)
Weight and Capacity			
Weight Armless	29.5 lb	39.5 lb	39.5 lb
Weight With Arms	33.4 lb	44.4 lb	44.4 lb
Weight Capacity Warranty	250 lb	250 lb	250 lb

# Focus

## MESH BACK TASK CHAIR

*Where comfort, style and ergonomics converge.*

Experience something so comfortable it hardly ever crosses your mind—from the moment you sit down until it's time to head home. Our best-selling seating solution works just about anywhere you need thanks to a wider back frame, extra-deep seat and almost endless options to customize.

Our signature dual-curve frame takes its cues from modern, industrial design while also reinforcing key points of contact, so your back is optimally supported throughout the day.



*Best*

**EFFECTIVE DECEMBER 1, 2021**

### Featured Models

#### **GOOD :: \$708**

Midback, swivel-tilt mechanism, height-adjustable arms, nylon base, grade 1 textile

#### **BETTER :: \$810**

Highback, enhanced synchro mechanism, height-adjustable arms, nylon base, grade 1 textile

#### **BEST :: \$1,005**

Highback, adjustable lumbar, enhanced synchro mechanism with seat-depth adjustment, fully multi-adjustable (10-way) sport arms, nylon base, grade 1 textile





## MESH BACK TASK CHAIR



### Features

- Ergonomic back support and comfort
- Midback and highback
- Looser-weave mesh for extra breathability
- Five bleach-cleanable mesh colors
- Adjustable lumbar option
- Nine ergonomic arm styles with standard or sport arm pads
- Black or silver accents
- Waterfall seat
- Optional sport casters
- Complements Focus 2.0 task chair and Focus Side chair, counter and bar stool; see page 69 and page 215
- Standard 300 lb weight capacity warranty; Heavy Duty Series - 350 lb and 400 lb weight capacity options

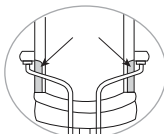
#### 1. Back



Back Size and Style	Code	Price	
Midback Mesh	5622 B1	\$778	
Highback Mesh	5623 B1	\$810	
Back Options	Code	Price	
Adjustable Lumbar Support	LB1	+ \$50	

#### 2. Heavy Duty

Heavy Duty Series	Code	Price	
Heavy Duty	HD	+ \$126	
Large and Tall (Black Highback Frame With Enhanced Synchro Y Mechanism and Sport Height-Adjustable A152 Arms)	LT	+ \$250	

Heavy duty model (HD) is only available with enhanced synchro (Y) mechanism. Heavy Duty model (HD) is not available with fixed arms (A91). See the Heavy Duty Guide on page 536 for additional LT and HD options.

#### 3. Mechanism

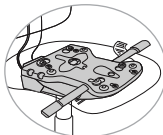
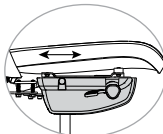
Mechanism Style	Code	Price	
Swivel-Tilt	T	- \$70	
Knee-Tilt	K	- \$57	
Enhanced Synchro	Y	+ \$0	
Enhanced Synchro Seat-Depth Adjustment	Y E3	+ \$79	

#### 4. Frame

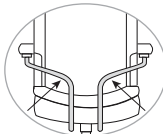
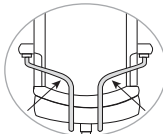
Back Support Color	Code	Price	
Black	Z1	+ \$0	
Silver	Z2	+ \$0	

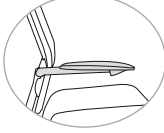
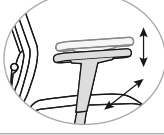
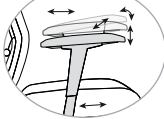

## 5. Arms

Arm Style	Code	Price	
Armless	A0	- \$90	
Fixed Arms	A91	- \$15	
Height-Adjustable	A92	+ \$0	
Height-Adjustable With Sport Arm Pads	A152	+ \$0	
Height-/Width-Adjustable	A93	+ \$25	
Height-/Width-Adjustable With Sport Arm Pads	A153	+ \$25	
Fully Adjustable (6-Way)	A94	+ \$56	
Fully Adjustable (6-Way) With Sport Arm Pads	A154	+ \$56	
Fully Multi-Adjustable (10-Way)	A95	+ \$66	
Fully Multi-Adjustable (10-Way) With Sport Arm Pads	A155	+ \$66	

Fixed arms (A91) not available with enhanced synchro (Y) mechanism.

## MESH BACK TASK CHAIR

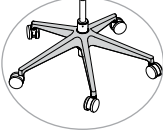
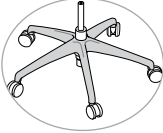
## 6. Base

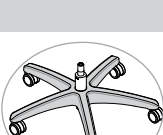
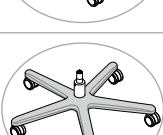
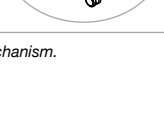
Base Color and Style	Code	Price	
Black Nylon	B0	+ \$0	
High Profile Polished Aluminum Base	B3	+ \$113	
High Profile Brushed Aluminum Base	B8	+ \$113	
Low Profile Base With Higher Cylinder	S8	+ \$0	
<b>Heavy Duty Bases (For HD/LT)</b>			
Black Nylon Base, 26"	B7	+ \$0	
Polished Aluminum Base	B5	+ \$167	

Low profile base (S8) only available with enhanced synchro (Y) mechanism.

**6. Base (Cont.)**

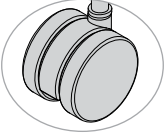
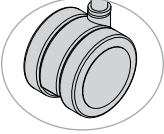
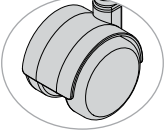
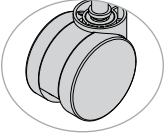
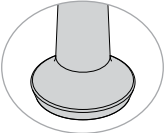
Casters or Glides	Code	Price	
<b>Casters</b>			
Carpet Casters	C15	+ \$0	
Sport Carpet Casters	C31	+ \$0	
Sport Hard Floor and Carpet Casters	C32	+ \$40	
Hard Floor and Carpet Casters	C14	+ \$40	
Self-Locking Carpet Casters	C20	+ \$30	
Self-Locking Hard Floor and Carpet Casters	C19	+ \$64	
<b>Heavy Duty Casters (For HD and LT)</b>			
Heavy Duty Carpet Casters	C11	+ \$0	
Heavy Duty Hard Floor and Carpet Casters	C9	+ \$61	
<b>Glides</b>			
Glides for Task Chairs	C3	+ \$30	

Self-locking casters (C19/C20) lock only when not in use.

**MESH BACK TASK CHAIR**

**7. Material**

Protection	Code	Price	
<b>Fire Retardancy</b>			
CAL 133, Fabric, Quantities 1-49	133F	+ \$99	
CAL 133, Fabric, Quantities 50+	133F5	+ \$55	
CAL 133, Leather, Any Quantity	133L	+ \$119	
<b>Mesh Color</b>			
Black	MC1	+ \$0	
Sand	MC3	+ \$0	
Slate	MC2	+ \$0	
Freeway Sport Stripe (Black/Slate)	MC33	+ \$0	
Impress Sport Stripe (Slate/Black)	MC34	+ \$0	
<b>Seat Textile</b>			
Fabric/Vinyl Grade 1	FG1/VG1	+ \$0	
COM	COM	+ \$26	
Fabric/Vinyl Grade 2	FG2/VG2	+ \$26	
Fabric/Vinyl Grade 3	FG3/VG3	+ \$60	
Fabric/Vinyl Grade 4	FG4/VG4	+ \$116	
Fabric/Vinyl Grade 5	FG5/VG5	+ \$172	
Fabric/Vinyl Grade 6	FG6/VG6	+ \$213	
Fabric/Vinyl Grade 7	FG7/VG7	+ \$254	
Leather Grade 1	LG1	+ \$300	
COL	COL	+ \$380	
Leather Grade 2	LG2	+ \$380	
Leather Grade 3	LG3	+ \$480	

Sport striped meshes list the predominant color first.

Please reference the Textile Reference Guide for pricing on fabric over grade 7 and leather over grade 3. Additional CAL 133 information can be found on page 10.

**8. Packaging**

Packaging	Code	Price	
Knocked Down	KD	+ \$0	
Back Attached to Seat, Base Separate	UC	+ \$80	
Fully Assembled in Carton	AC	+ \$200	

### SPECIFICATIONS

	5622 B1 Midback Mesh Task Chair	5623 B1 Highback Mesh Task Chair	5623 B1 LT Highback Mesh Large and Tall Task Chair
<b>Dimensions</b>			
Overall Width Armless	26"	26"	26"
Overall Width With Arms	27.3"	27.5"	29"
Overall Depth	25"	26"	27.75"
Overall Height	35" 35.5" (B3/B8)	39" 39.5" (B3/B8)	38" (B7), 39" (B5)
Seat Width	19"	19"	22"
Seat Depth	18.5"-20.75"	18.5"-20.75"	17.5"
Seat Height	16.5"-20.125" (T) 17.5"-20.5" (K) 16.75"-20.75" (Y)  16.88"-20.25" (Y) (B3/B8)	16.5"-20.125" (T) 17.5"-20.5" (K) 16.75"-20.75" (Y)  16.88"-20.25" (Y) (B3/B8)	17.5"-21.5" (Y/B7) 16.88"-20.25" (Y/B5)
Back Width	18.25"	18.3"	18.3"
Back Height	20"	23.5"	21.5"
<b>Materials</b>			
COM	1 yd	1 yd	1.15 yd
COL	17 sq ft	17 sq ft	25 sq ft
<b>Weight and Capacity</b>			
Weight Armless	35.5 lb	36.5 lb	47 lb
Weight With Arms	41.5 lb	42.5 lb	53 lb
Weight Capacity Warranty	300 lb 350 lb (HD)	300 lb 350 lb (HD)	400 lb

Swivel-tilt mechanism (T). Knee-tilt mechanism (K). Enhanced synchro mechanism (Y).  
High profile polished aluminum base (B3). High profile brushed aluminum base (B8).  
Heavy Duty (HD). Heavy Duty black nylon base (B7). Heavy duty polished aluminum  
base (B5).



Better

# Focus

## MESH BACK TASK STOOL

*Where comfort, style and ergonomics converge.*

Experience something so comfortable it hardly ever crosses your mind—from the moment you sit down until it's time to head home. Our best-selling seating solution works just about anywhere you need thanks to a wider back frame, extra-deep seat and almost endless options to customize.

Our signature dual-curve frame takes its cues from modern, industrial design while also reinforcing key points of contact, so your back is optimally supported throughout the day.



**EFFECTIVE DECEMBER 1, 2021**

### Featured Models

**GOOD :: \$737**

Midback mesh task stool, basic mechanism, armless, nylon base, grade 1 textile

**BETTER :: \$859**

Highback mesh task stool, basic mechanism, height-adjustable arms, nylon base, grade 1 textile



**BEST :: \$999**

Highback mesh task stool with adjustable lumbar support, basic mechanism, 10-way arms with sport pads, extended stool kit, nylon base, grade 1 textile

## Features

- Ergonomic back support and comfort
- Midback and highback
- Looser-weave mesh for extra breathability
- Five bleach-cleanable mesh colors
- Adjustable lumbar option
- Nine ergonomic arm styles with standard or Sport arm pads
- Black or silver accents
- Waterfall seat
- Optional Sport casters
- Complements Focus 2.0 task chair and Focus Side chair, counter and bar stool; see page 69 and page 215
- Standard 300 lb weight capacity warranty

### 1. Back

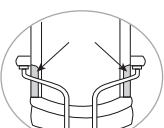
Back Size and Style	Code	Price	
Midback Mesh	5622 B1	\$827	
Highback Mesh	5623 B1	\$859	
Back Options	Code	Price	
Adjustable Lumbar Support	LB1	+ \$50	

## MESH BACK TASK STOOL

### 2. Mechanism

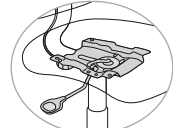
Mechanism Style	Code	Price	
Basic (Swivel Only)	B	+\$0	



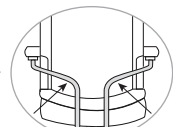

### 3. Frame

Back Support Color	Code	Price	
Black	Z1	+ \$0	
Silver	Z2	+ \$0	



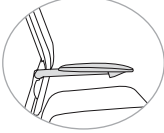
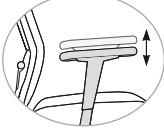
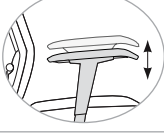
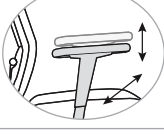
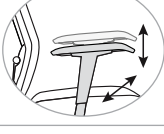
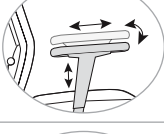

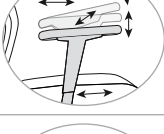
Good

## 4. Arms

Arm Style	Code	Price	
Armless	A0	- \$90	
Fixed Arms	A91	- \$15	
Height-Adjustable	A92	+ \$0	
Height-Adjustable With Sport Arm Pads	A152	+ \$0	
Height-/Width-Adjustable	A93	+ \$25	
Height-/Width-Adjustable With Sport Arm Pads	A153	+ \$25	
Fully Adjustable (6-Way)	A94	+ \$56	
Fully Adjustable (6-Way) With Sport Arm Pads	A154	+ \$56	
Fully Multi-Adjustable (10-Way)	A95	+ \$66	
Fully Multi-Adjustable (10-Way) With Sport Arm Pads	A155	+ \$66	

## MESH BACK TASK STOOL

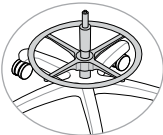
## 5. Base

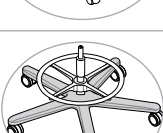
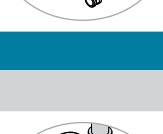
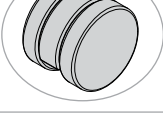
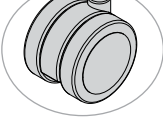
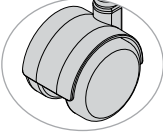
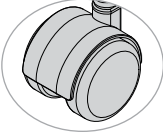
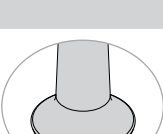
Base	Code	Price	
Stool Kit	S1	+ \$0	
Extended Stool Kit	S2	+ \$24	
Base Color and Material	Code	Price	
Black Nylon Base	B6	+ \$0	
Polished Aluminum Base	B5	+ \$167	
Casters or Glides	Code	Price	
<b>Casters</b>			
Carpet Casters	C5	+ \$0	
Carpet Casters (For Higher Cylinder)	C21	+ \$0	
Sport Carpet Casters	C31	+ \$0	
Sport Hard Floor and Carpet Casters	C32	+ \$40	
Hard Floor and Carpet Casters	C1	+ \$40	
Hard Floor and Carpet Casters (For Higher Cylinder)	C22	+ \$40	
Self-Locking Carpet Casters	C2	+ \$30	
Self-Locking Hard Floor and Carpet Casters	C7	+ \$61	
<b>Glides</b>			
Glides for Task Chairs	C3	+ \$30	

Self-locking casters (C2/C7) lock only when not in use.

**6. Material**

Protection	Code	Price	
<b>Fire Retardancy</b>			
CAL 133, Fabric, Quantities 1-49	133F	+ \$99	
CAL 133, Fabric, Quantities 50+	133F5	+ \$55	
CAL 133, Leather, Any Quantity	133L	+ \$119	
Mesh Color	Code	Price	
Black	MC1	+ \$0	
Sand	MC3	+ \$0	
Slate	MC2	+ \$0	
Freeway Sport Stripe (Black/Slate)	MC33	+ \$0	
Impress Sport Stripe (Slate/Black)	MC34	+ \$0	
Seat Textile	Code	Price	
Fabric/Vinyl Grade 1	FG1/VG1	+ \$0	
COM	COM	+ \$26	
Fabric/Vinyl Grade 2	FG2/VG2	+ \$26	
Fabric/Vinyl Grade 3	FG3/VG3	+ \$60	
Fabric/Vinyl Grade 4	FG4/VG4	+ \$116	
Fabric/Vinyl Grade 5	FG5/VG5	+ \$172	
Fabric/Vinyl Grade 6	FG6/VG6	+ \$213	
Fabric/Vinyl Grade 7	FG7/VG7	+ \$254	
Leather Grade 1	LG1	+ \$300	
COL	COL	+ \$380	
Leather Grade 2	LG2	+ \$380	
Leather Grade 3	LG3	+ \$480	

*Sport striped meshes list the predominant color first.*

*Please reference the Textile Reference Guide for pricing on fabric over grade 7 and leather over grade 3. Additional CAL 133 information can be found on page 10.*

**7. Packaging**

Packaging	Code	Price	
Knocked Down	KD	+ \$0	
Back Attached to Seat, Base Separate	UC	+ \$80	
Fully Assembled in a Carton	AC	+ \$200	

**MESH BACK TASK STOOL**

**MIDBACK SPECIFICATIONS**

	5622 B1 S1 Midback Task Stool	5622 B1 S2 Midback Extended Task Stool
<b>Dimensions</b>		
Overall Width Armless	27.3"	27.3"
Overall Width With Arms	27.3"	27.3"
Overall Depth	25"	25"
Overall Height	41.6"	46"
Seat Width	19"	19"
Seat Depth	18.5"	18.5"
Seat Height	21"-29"	24"-34"
Back Width	18.25"	18.25"
Back Height	20"	20"
<b>Materials</b>		
COM	1 yd	1 yd
COL	17 sq ft	17 sq ft
<b>Weight and Capacity</b>		
Weight Armless	39.5 lb	40.5 lb
Weight With Arms	45.5 lb	46.5 lb
Weight Capacity Warranty	300 lb	300 lb

**HIGHBACK SPECIFICATIONS**

	5623 B1 S1 Highback Task Stool	5623 B1 S2 Highback Extended Task Stool
<b>Dimensions</b>		
Overall Width Armless	20"	20"
Overall Width With Arms	27.5"	27.5"
Overall Depth	26"	26"
Overall Height	45"	50"
Seat Width	20"	20"
Seat Depth	18.5"	18.5"
Seat Height	21"-29"	24"-34"
Back Width	18.3"	18.3"
Back Height	23.5"	23.5"
<b>Materials</b>		
COM	1 yd	1 yd
COL	17 sq ft	17 sq ft
<b>Weight and Capacity</b>		
Weight Armless	40.5 lb	41.5 lb
Weight With Arms	46.5 lb	47.5 lb
Weight Capacity Warranty	300 lb	300 lb



# Focus

## UPHOLSTERED BACK TASK CHAIR

*Where comfort, style and ergonomics converge.*

Experience something so comfortable it hardly ever crosses your mind—from the moment you sit down until it's time to head home. Our best-selling seating solution works just about anywhere you need thanks to a wider back frame, extra-deep seat and almost endless options to customize.

Our signature dual-curve frame takes its cues from modern, industrial design while also reinforcing key points of contact, so your back is optimally supported throughout the day.



**EFFECTIVE DECEMBER 1, 2021**

### Featured Models

#### **GOOD :: \$834**

Midback upholstered pad, swivel-tilt mechanism, height-adjustable arms, nylon base, carpet casters, grade 1 textile

#### **BETTER :: \$936**

Highback upholstered pad, enhanced synchro mechanism, sport height-adjustable arms, nylon base, carpet casters grade 1 textile

#### **BEST :: \$1,131**

Highback upholstered pad, adjustable lumbar, enhanced synchro mechanism with seat depth adjustment, fully multi-adjustable (10-way) sport arms, nylon base, carpet casters, grade 1 textile

## Features

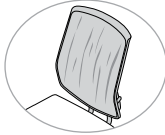
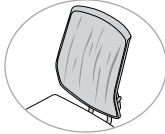
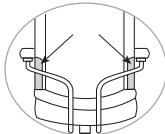

- Ergonomic back support and comfort
- Midback and highback
- Relaxed-fit upholstered pad
- Adjustable lumbar option
- Nine ergonomic arm styles with standard or Sport arm pads
- Black or silver accents
- Waterfall seat
- Optional Sport casters
- Complements Focus 2.0 task chair and Focus Side chair, counter and bar stool; see page 69 and page 215
- Standard 300 lb weight capacity warranty;  
Heavy Duty Series - 350 lb and 400 lb weight capacities

### 1. Back

Back Size and Style	Code	Price	
Midback Relaxed-Fit Upholstered Pad	5622 B4	\$904	
Highback Relaxed-Fit Upholstered Pad	5623 B4	\$936	
Back Options	Code	Price	
Adjustable Lumbar Support	LB1	+ \$50	



## UPHOLSTERED BACK TASK CHAIR

### 2. Heavy Duty

Heavy Duty Series	Code	Price	
Heavy Duty	HD	+ \$126	
Large and Tall (Black Highback Frame With Enhanced Synchro Y Mechanism and Sport Height-Adjustable A152 Arms)	LT	+ \$250	

Heavy Duty model (HD) only available with enhanced synchro (Y) mechanism. See page 536 for additional options Heavy Duty and Large and Tall options.

### 3. Mechanism

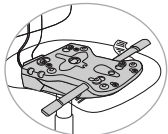
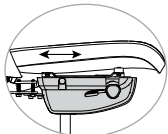
Mechanism	Code	Price	
Swivel-Tilt	T	- \$70	
Knee-Tilt	K	- \$57	
Enhanced Synchro	Y	+ \$0	
Enhanced Synchro With Seat-Depth Adjustment	Y E3	+ \$79	

### 4. Frame

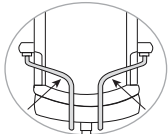
Back Support Color	Code	Price	
Black	Z1	+ \$0	
Silver	Z2	+ \$0	





## UPHOLSTERED BACK TASK CHAIR

### 5. Arms

Arm Style	Code	Price	
Armless	A0	- \$90	
Fixed Arms	A91	- \$15	
Height-Adjustable	A92	+ \$0	
Height-Adjustable With Sport Arm Pads	A152	+ \$0	
Height-/Width-Adjustable	A93	+ \$25	
Height-/Width-Adjustable With Sport Arm Pads	A153	+ \$25	
Fully Adjustable (6-Way)	A94	+ \$56	
Fully Adjustable (6-Way) With Sport Arm Pads	A154	+ \$56	
Fully Multi-Adjustable (10-Way)	A95	+ \$66	
Fully Multi-Adjustable (10-Way) With Sport Arm Pads	A155	+ \$66	

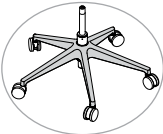
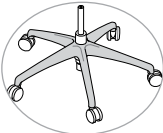
Fixed arms (A91) are not available with the enhanced synchro (Y) mechanism.

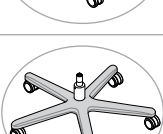
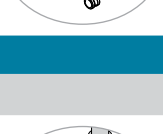
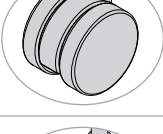
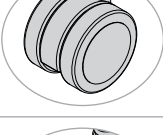
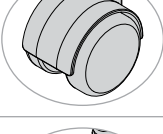
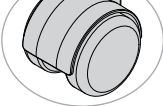
### 6. Base

Base and Color	Code	Price	
Black Nylon Base	B0	+ \$0	
High Profile Polished Aluminum Base	B3	+ \$113	
High Profile Brushed Aluminum Base	B8	+ \$113	
Low Profile Nylon Base With Higher Cylinder	S8	+ \$0	
<b>Heavy Duty Bases (For HD/LT)</b>			
Black Nylon Base, 26"	B7	+ \$0	
Polished Aluminum	B5	+ \$167	
Casters or Glides	Code	Price	
<b>Casters</b>			
Carpet Casters	C15	+ \$0	
Sport Carpet Casters	C31	+ \$0	
Sport Hard Floor and Carpet Casters	C32	+ \$40	
Hard Floor and Carpet Casters	C14	+ \$40	
Self-Locking Carpet Casters	C20	+ \$30	
Self-Locking Hard Floor and Carpet Casters	C19	+ \$64	

Low profile base (S8) only available with enhanced synchro (Y) mechanism.  
Heavy Duty bases (B5/B7) are for use with the HD and LT models.

## 6. Base (Cont.)

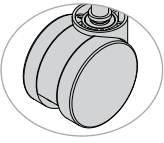
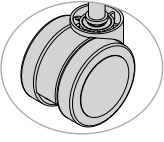
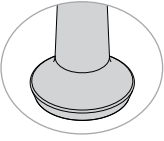
Casters or Glides	Code	Price	
<b>Heavy Duty Casters (For HD and LT)</b>			
Heavy Duty Carpet Casters	C11	+ \$0	
Heavy Duty Hard Floor and Carpet Casters	C9	+ \$61	
<b>Glides</b>			
Glides for Task Chairs	C3	+ \$30	

Self-locking casters (C20/C19) lock only when not in use.

## 7. Material

Protection	Code	Price	
<b>Fire Retardancy</b>			
CAL 133, Fabric, Quantities 1-49	133F	+ \$99	
CAL 133, Fabric, Quantities 50+	133F5	+ \$55	
CAL 133, Leather, Any Quantity	133L	+ \$119	
Seat and Back Textile	Code	Price	
Fabric/Vinyl Grade 1	FG1/VG1	+ \$0	
COM	COM	+ \$34	
Fabric/Vinyl Grade 2	FG2/VG2	+ \$34	
Fabric/Vinyl Grade 3	FG3/VG3	+ \$74	
Fabric/Vinyl Grade 4	FG4/VG4	+ \$121	
Fabric/Vinyl Grade 5	FG5/VG5	+ \$174	
Fabric/Vinyl Grade 6	FG6/VG6	+ \$235	
Fabric/Vinyl Grade 7	FG7/VG7	+ \$296	
Leather Grade 1	LG1	+ \$260	
COL	COL	+ \$320	
Leather Grade 2	LG2	+ \$320	
Leather Grade 3	LG3	+ \$400	

Please reference the *Textile Reference Guide* for pricing on fabric over grade 7 and leather over grade 3. Additional CAL 133 information can be found on page 10.

## UPHOLSTERED BACK TASK CHAIR

## 8. Packaging

Base and Color and Material	Code	Price	
Knocked Down	KD	+ \$0	
Back Attached to Seat, Base Separate	UC	+ \$80	
Fully Assembled in a Carton	AC	+ \$200	



Better

### SPECIFICATIONS

	5622 B4 Midback Task Chair	5623 B4 Highback Task Chair	5623 B1 LT Large and Tall Task Chair
<b>Dimensions</b>			
Overall Width Armless	26"	26"	26"
Overall Width With Arms	27.3"	27.5"	29"
Overall Depth	25"	26"	27.75"
Overall Height	35" (B0), 35.5" (B3/B8)	39" (B0), 39.5" (B3/B8)	38.5" (B7), 39.75" (B5)
Seat Width	19"	19"	22"
Seat Depth	18.5"-20.75"	18.5"-20.75"	17.5"
Seat Height	16.5"-20.125" (T) 17.5"-20.5" (K) 16.75"-20.75" (Y)	16.5"-20.125" (T) 17.5"-20.5" (K) 16.75"-20.75" (Y)	17.5"-21.5" (Y) (B7)
	16.88"-20.25" (Y) (B3/B8)	16.88"-20.25" (Y) (B3/B8)	16.88"-20.25" (Y) (B5)
Back Width	18.25"	18.3"	18.3"
Back Height	20"	23.5"	21.5"
<b>Materials</b>			
COM	1.15 yd	1.25 yd	1.25 yd
COL	23 sq ft	25 sq ft	31 sq ft
<b>Weight and Capacity</b>			
Weight Armless	35.5 lb	36.5 lb	47 lb
Weight With Arms	41.5 lb	42.5 lb	53 lb
Weight Capacity	300 lb	300 lb	400 lb
Warranty	350 lb (HD)	350 (HD)	

Swivel tilt mechanism (T). Knee tilt mechanism (K). Enhanced synchro mechanism (Y). High profile polished aluminum base (B3). High profile brushed aluminum base (B8). Heavy Duty (HD). Heavy Duty black nylon base (B7). Heavy Duty polished aluminum base (B5).



Good

# Focus

## UPHOLSTERED BACK TASK STOOL

*Where comfort, style and ergonomics converge.*

Experience something so comfortable it hardly ever crosses your mind—from the moment you sit down until it's time to head home. Our best-selling seating solution works just about anywhere you need thanks to a wider back frame, extra-deep seat and almost endless options to customize.

Our signature dual-curve frame takes its cues from modern, industrial design while also reinforcing key points of contact, so your back is optimally supported throughout the day. Plus, a built-in lumbar system helps promote correct posture so that you spend more time working and less time (re)adjusting your seat.



**EFFECTIVE DECEMBER 1, 2021**

### Featured Models

#### **GOOD :: \$863**

Midback upholstered, task stool, basic mechanism, armless, black nylon base, grade 1 textile

#### **BETTER :: \$985**

Highback upholstered, task stool, basic mechanism, height-adjustable arms, black nylon base, grade 1 textile

#### **BEST :: \$1,125**



Highback upholstered, task stool, adjustable lumbar support, basic mechanism, 10-way arms with sport pads, extended stool kit, black nylon base, grade 1 textile

## UPHOLSTERED BACK TASK STOOL

### Features

- Ergonomic back support and comfort
- Midback and highback
- Relaxed-fit upholstered pad
- Adjustable lumbar option
- Nine ergonomic arm styles with standard or Sport arm pads
- Black or silver accents
- Waterfall seat
- Optional Sport casters
- Complements Focus 2.0 task chair and Focus Side chair, counter and bar stool; see page 69 and page 215
- Standard 300 lb weight capacity warranty

#### 1. Back

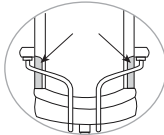
Back Size and Style	Code	Price	
Midback Relaxed-Fit Upholstered Pad	5622 B4	\$953	
Highback Relaxed-Fit Upholstered Pad	5623 B4	\$985	
Back Options	Code	Price	
Adjustable Lumbar Support	LB1	+ \$50	

#### 2. Mechanism

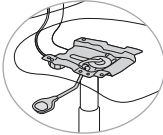
Mechanism	Code	Price	
Basic (Swivel Only)	B	+\$0	

#### 3. Frame

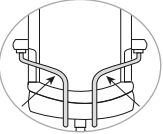
Back Support Color	Code	Price	
Black	Z1	+ \$0	
Silver	Z2	+ \$0	







## 4. Arms

Arm Style	Code	Price	
Armless	A0	- \$90	
Fixed Arms	A91	- \$15	
Height-Adjustable	A92	+ \$0	
Height-Adjustable With Sport Arm Pads	A152	+ \$0	
Height-/Width-Adjustable	A93	+ \$25	
Height-/Width-Adjustable With Sport Arm Pads	A153	+ \$25	
Fully Adjustable (6-Way)	A94	+ \$56	
Fully Adjustable (6-Way) With Sport Arm Pads	A154	+ \$56	
Fully Multi-Adjustable (10-Way)	A95	+ \$66	
Fully Multi-Adjustable (10-Way) With Sport Arm Pads	A155	+ \$66	

Fixed arms (A91) are not available with the enhanced synchro (Y) mechanism.

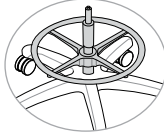
## UPHOLSTERED BACK TASK STOOL

## 5. Base

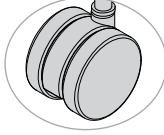
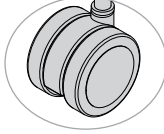
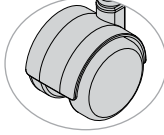
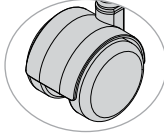
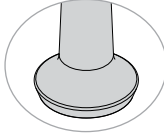
Base	Code	Price	
Stool Kit	S1	+ \$0	
Extended Stool Kit	S2	+ \$24	
Base Color and Material	Code	Price	
Black Nylon Base	B6	+ \$0	
Polished Aluminum Base	B5	+ \$167	
Casters or Glides	Code	Price	
<b>Casters</b>			
Carpet Casters	C5	+ \$0	
Carpet Casters (For Higher Cylinder Only)	C21	+ \$0	
Sport Carpet Casters	C31	+ \$0	
Sport Hard Floor and Carpet Casters	C32	+ \$40	
Hard Floor and Carpet Casters	C1	+ \$40	
Hard Floor and Carpet Casters (For Higher Cylinder Only)	C22	+ \$40	
Self-Locking Carpet Casters	C2	+ \$30	
Self-Locking Hard Floor and Carpet Casters	C7	+ \$61	
<b>Glides</b>			
Glides for Task Chairs	C3	+ \$30	

Self-locking casters (C2/C7) lock only when not in use.



## 6. Material

Protection	Code	Price	
<b>Fire Retardancy</b>			
CAL 133, Fabric, Quantities 1-49	133F	+ \$99	
CAL 133, Fabric, Quantities 50+	133F5	+ \$55	
CAL 133, Leather, Any Quantity	133L	+ \$119	
Seat and Back Textile	Code	Price	
COM	FG1/VG1	+ \$0	
Fabric/Vinyl Grade 1	COM	+ \$34	
Fabric/Vinyl Grade 2	FG2/VG2	+ \$34	
Fabric/Vinyl Grade 3	FG3/VG3	+ \$74	
Fabric/Vinyl Grade 4	FG4/VG4	+ \$121	
Fabric/Vinyl Grade 5	FG5/VG5	+ \$174	
Fabric/Vinyl Grade 6	FG6/VG6	+ \$235	
Fabric/Vinyl Grade 7	FG7/VG7	+ \$296	
Leather Grade 1	LG1	+ \$260	
COL	COL	+ \$320	
Leather Grade 2	LG2	+ \$320	
Leather Grade 3	LG3	+ \$400	

Please reference the *Textile Reference Guide* for pricing on fabric over grade 7 and leather over grade 3. Additional CAL 133 information can be found on page 10.

## 7. Packaging

Packaging	Code	Price	
Knocked Down	KD	+ \$0	
Back Attached to Seat, Base Separate	UC	+ \$80	
Fully Assembled in a Carton	AC	+ \$200	

## UPHOLSTERED BACK TASK STOOL

### MIDBACK SPECIFICATIONS

	5622 B4 S1 Upholstered Task Stool	5622 B4 S2 Upholstered Extended Task Stool
<b>Dimensions</b>		
Overall Width Armless	27.3"	27.3"
Overall Width With Arms	27.3"	27.3"
Overall Depth	25"	25"
Overall Height	41.6"	46"
Seat Width	19"	19"
Seat Depth	18.5"	18.5"
Seat Height	21"-29"	24"-34"
Back Width	18.25"	18.25"
Back Height	20"	20"
<b>Materials</b>		
COM	1.15 yd	1.15 yd
COL	23 sq ft	23 sq ft
<b>Weight and Capacity</b>		
Weight Armless	39.5 lb	40.5 lb
Weight With Arms	45.5 lb	46.5 lb
Weight Capacity	300 lb	300 lb

### HIGHBACK SPECIFICATIONS

	5623 B4 S1 Upholstered Task Stool	5623 B4 S2 Upholstered Extended Task Stool
<b>Dimensions</b>		
Overall Width Armless	20"	20"
Overall Width With Arms	27.5"	27.5"
Overall Depth	26"	26"
Overall Height	45"	50"
Seat Width	20"	20"
Seat Depth	18.5"	18.5"
Seat Height	21"-29"	24"-34"
Back Width	18.3"	18.3"
Back Height	23.5"	23.5"
<b>Materials</b>		
COM	1.15 yd	1.15 yd
COL	23 sq ft	23 sq ft
<b>Weight and Capacity</b>		
Weight Armless	40.5 lb	41.5 lb
Weight With Arms	46.5 lb	47.5 lb
Weight Capacity	300 lb	300 lb

# Focus 2.0

## MESH BACK TASK CHAIR

### *Focus reimagined.*

Focus™ 2.0 is more than a makeover. It's a modernization. It's driving dependable design forward with innovative mesh, enhanced (and expanded) customization, advanced functionality and a slimmer silhouette that offers superior comfort from integrated lumbar support and cutting-edge ergonomics. Focus 2.0 is everything you loved in the first generation and more.



Best

EFFECTIVE DECEMBER 1, 2021

### Featured Models

#### **GOOD :: \$629**

Midback mesh with adjustable lumbar support, swivel-tilt mechanism, height-adjustable arms, black frame, black nylon Y-support, black nylon base, accent color, carpet casters, grade 1 textile

#### **BETTER :: \$752**

Highback mesh back with adjustable lumbar support, enhanced synchro mechanism, height-/width-adjustable (4-way) arms, black frame, black nylon Y-support, black nylon base, accent color, carpet casters, grade 1 textile

#### **BEST :: \$926**

Highback mesh with adjustable lumbar support, enhanced synchro mechanism with seat-depth adjustment, fully adjustable (8-way) arms, white frame, piano black Y-support, white nylon base, accent color, carpet casters, grade 1 textile



# FOCUS 2.0

EFFECTIVE DECEMBER 1, 2021 | GSA SIN #: 33721

## Features

- Slimmer, refined design
- Swivel-tilt and enhanced synchro mechanism
- Modernized Y-support customizable in four colors, including piano black
- Three frame and four base colors
- Armless, height-adjustable, height-/width-adjustable or fully adjustable arms
- 12 accent colors for pull handle stripe, lumbar casing, arm adjustment and caster rings
- Three exclusive mesh options in Focus mesh, Focus 2.0 mesh and Focus Uptown mesh
- Adjustable lumbar support included
- Performance casters color coordinate with frame and base
- Complements Focus task chair and Focus Side chair, counter and bar stool; see page 51 page 215
- 300 lb weight capacity warranty

### 1. Back

Back Size and Style	Code	Price	
Midback Mesh With Adjustable Lumbar	1123 BK1 MB	\$699	
Highback Mesh With Adjustable Lumbar	1123 BK2 MB	\$727	

## MESH BACK TASK CHAIR

### 2. Mechanism

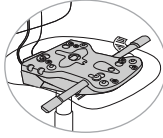
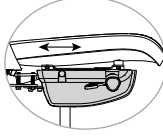
Mechanism Style	Code	Price	
Swivel-Tilt	T	- \$70	
Enhanced Synchro	Y	+ \$0	
Enhanced Synchro With Seat-Depth Adjustment	Y/E3	+ \$79	

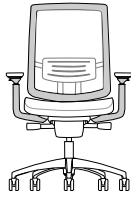
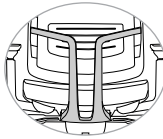

### 3. Frame

Frame Color	Code	Price	
Black	FC1	+ \$0	
Fog	FC13	+ \$35	
White	FC12	+ \$35	
Y-Support Color	Code	Price	
Black	YCC01	+ \$0	
White	YCC02	+ \$0	
Fog	YCC03	+ \$0	
Piano Black	YCC04	+ \$25	

# FOCUS 2.0

EFFECTIVE DECEMBER 1, 2021 | GSA SIN #: 33721

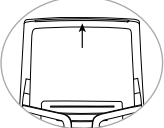
## 3. Frame (Cont.)

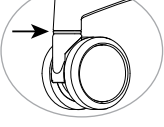



Accent Color	Code	Price	
Apple	LA12	+ \$0	
Desert	LA3	+ \$0	
Electric Blue	LA5	+ \$0	
Fire	LA6	+ \$0	
Fog	LA4	+ \$0	
Graphite	LA14	+ \$0	
Navy	LA15	+ \$0	
Nickel	LA2	+ \$0	
Ocean	LA10	+ \$0	
Onyx	LA1	+ \$0	
Tangerine	LA9	+ \$0	
White	LA13	+ \$0	

Due to the high-gloss material, the piano black Y-support (YCC04) is more susceptible to scratches and scuffs in a workstation environment and requires more care when removing protective packaging. Scratches and scuffs may not be covered under warranty.

Accent color is applied to pull handle stripe, lumbar casing, arm adjustment and caster rings.

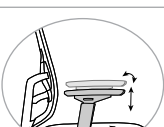

## MESH BACK TASK CHAIR

## 4. Arms

Arm Style	Code	Price	
Armless	AR0	- \$48	
Fixed Arms	AR2	- \$10	
Height-Adjustable	AR4	+ \$0	
Height-/Width-Adjustable (4-Way)	AR6	+ \$25	
Fully Adjustable (8-Way)	AR9	+ \$60	

Arms, if specified, come with fog arm pads for the white (FC12) and fog (FC13) frames and black arm pads for the black frame (FC1).

## 5. Base

Base Style	Code	Price	
5-Star Nylon	BT1	+ \$0	
5-Star Polished Aluminum	BT2	+ \$113	

Nylon Base Color	Code	Price	
Black Nylon Base	BC1	+ \$0	
Fog Nylon Base	BC4	+ \$0	
White Nylon Base	BC3	+ \$0	

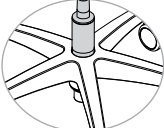
Cylinder Height	Code	Price	
Higher Cylinder	CH3	+ \$0	
Standard Cylinder	CH1	+ \$0	

# FOCUS 2.0

EFFECTIVE DECEMBER 1, 2021 | GSA SIN #: 33721

## 5. Base (Cont.)

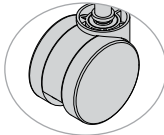
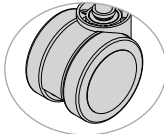
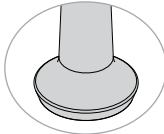
Casters or Glides	Code	Price	
<b>Casters</b>			
Carpet Casters	CS5	+ \$0	
Hard Floor and Carpet Casters	CS6	+ \$40	
<b>Glides</b>			
Glides for Task Chairs	CS3	+ \$30	

## 6. Material

Mesh	Code	Price	
<b>Focus 2.0 Mesh</b>			
Apple	MC31	+ \$0	
Desert	MC9	+ \$0	
Electric Blue	MC13	+ \$0	
Fire	MC10	+ \$0	
Fog	MC7	+ \$0	
Navy	MC8	+ \$0	
Nickel	MC6	+ \$0	
Ocean	MC29	+ \$0	
Onyx	MC5	+ \$0	
Tangerine	MC28	+ \$0	
<b>Focus 2.0 Uptown Mesh</b>			
Midnight	MC43	+ \$0	
Charcoal	MC44	+ \$0	
Ash	MC45	+ \$0	
Dune	MC46	+ \$0	
<b>Focus Mesh</b>			
Black	MC1	+ \$0	
Sand	MC3	+ \$0	
Slate	MC2	+ \$0	
Freeway Sport Stripe (Black/Slate)	MC33	+ \$0	
Impress Sport Stripe (Slate/Black)	MC34	+ \$0	

Sport striped meshes list the predominant color first.

## MESH BACK TASK CHAIR

## 6. Material (Cont.)

Seat Textile	Code	Price	
Fabric/Vinyl Grade 1	FG1/VG1	+ \$0	
COM	COM	+ \$26	
Fabric/Vinyl Grade 2	FG2/VG2	+ \$26	
Fabric/Vinyl Grade 3	FG3/VG3	+ \$60	
Fabric/Vinyl Grade 4	FG4/VG4	+ \$116	
Fabric/Vinyl Grade 5	FG5/VG5	+ \$172	
Fabric/Vinyl Grade 6	FG6/VG6	+ \$213	
Fabric/Vinyl Grade 7	FG7/VG7	+ \$254	
Leather Grade 1	LG1	+ \$300	
COL	COL	+ \$380	
Leather Grade 2	LG2	+ \$380	
Leather Grade 3	LG3	+ \$480	

Please reference the *Textile Reference Guide* for pricing on fabric over grade 7 and leather over grade 3.

## 7. Packaging

Mesh	Code	Price	
Knocked Down	KD	+ \$0	
Back Attached to Seat, Base Separate	UC	+ \$80	
Fully Assembled in a Carton	AC	+ \$200	

# FOCUS 2.0

EFFECTIVE DECEMBER 1, 2021 | GSA SIN #: 33721

## MESH BACK TASK CHAIR

### SPECIFICATIONS

	1123 BK1 MB Midback Mesh Task Chair	1123 BK2 MB Highback Mesh Task Chair
<b>Dimensions</b>		
Overall Width Without Arms	26"	26"
Overall Width With Arms	28"	26"
Overall Depth	27"	26"
Overall Height	35.25"-39"	38.8"-42.6"
Seat Width	19.6"	19.6"
Seat Depth	17.7"-19.6"	17.7"-19.6"
Seat Height	16.6"-20.1" (T) 16.9"-20.4" (Y)	16.6"-20.1" (T) 16.9"-20.4" (Y)
Seat Height With Higher Cylinder	17.1"-22.3" (T) 17.4"-22.6" (Y)	17.1"-22.3" (T) 17.4"-22.6" (Y)
Back Width	18.25"	18.25"
Back Height	19.5"	23.6"
<b>Materials</b>		
COM	1 yd	1 yd
COL	14 sq ft	14 sq ft
<b>Weight and Capacity</b>		
Weight Armless	38.2 lb	38.7 lb
Weight With Arms	43 lb	43.5 lb
Weight Capacity Warranty	300 lb	300 lb

Swivel-tilt mechanism (T). Enhanced synchro mechanism (Y).



# Focus 2.0

## MESH BACK TASK STOOL



### *Focus reimaged.*

Focus™ 2.0 is more than a makeover. It's a modernization. It's driving dependable design forward with innovative mesh, enhanced (and expanded) customization, advanced functionality and a slimmer silhouette that offers superior comfort from integrated lumbar support and cutting-edge ergonomics. Focus 2.0 is everything you loved in the first generation and more.

**EFFECTIVE DECEMBER 1, 2021**

### Featured Models

#### **GOOD :: \$728**

Midback mesh with adjustable lumbar support, basic mechanism, black frame, black Y-support, armless, standard stool kit, nylon base, carpet casters, grade 1 textile

#### **BETTER :: \$752**

Midback mesh with adjustable lumbar support, basic mechanism, white frame, white Y-support, height-adjustable arms, standard stool kit, nylon base, carpet casters, grade 1 textile

#### **BEST :: \$926**

Midback mesh with adjustable lumbar support, basic mechanism, fully adjustable (8-way) arms, black frame, piano black Y-support, polished aluminum base, carpet casters, grade 1 textile

# FOCUS 2.0

EFFECTIVE DECEMBER 1, 2021 | GSA SIN #: 33721

## Features

- Slimmer, refined design
- Swivel-tilt and enhanced synchro mechanism
- Modernized Y-support customizable in four colors, including piano black
- Three frame and four base colors
- Armless, height-adjustable, height-/width-adjustable or fully adjustable arms
- 12 accent colors for pull handle stripe, lumbar casing, arm adjustment and caster rings
- Three exclusive mesh options in Focus mesh, Focus 2.0 mesh and Focus Uptown mesh
- Adjustable lumbar support included
- Performance casters color coordinate with frame and base
- Complements Focus task chair and task stool and Focus Side chair, counter and bar stool; see page 51 and page 215
- 300 lb weight capacity warranty

### 1. Back



Back Size and Style	Code	Price	
Midback Mesh With Adjustable Lumbar	1123 BK1 MB	\$776	

### 2. Mechanism

Mechanism Style	Code	Price	
Basic (Swivel Only)	B	+ \$0	

## MESH BACK TASK STOOL

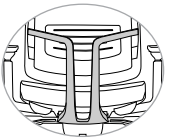
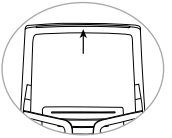
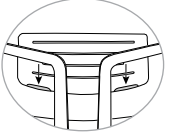
### 3. Frame

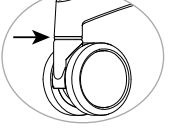
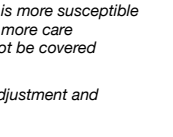
Frame Color	Code	Price	
Black	FC1	+ \$0	
Fog	FC13	+ \$35	
White	FC12	+ \$35	
Y-Support Color	Code	Price	
Black	YCC01	+ \$0	
White	YCC02	+ \$0	
Fog	YCC03	+ \$0	
Piano Black	YCC04	+ \$25	
Accent Color	Code	Price	
Apple	LA12	+ \$0	
Desert	LA3	+ \$0	
Electric Blue	LA5	+ \$0	
Fire	LA6	+ \$0	
Fog	LA4	+ \$0	
Graphite	LA14	+ \$0	
Navy	LA15	+ \$0	
Nickel	LA2	+ \$0	
Ocean	LA10	+ \$0	
Onyx	LA1	+ \$0	
Tangerine	LA9	+ \$0	
White	LA13	+ \$0	

Due to the high-gloss material, the piano black Y-support (YCC04) is more susceptible to scratches and scuffs in a workstation environment and requires more care when removing protective packaging. Scratches and scuffs may not be covered under warranty.



Accent color is applied to pull handle stripe, lumbar casing, arm adjustment and caster rings.



# FOCUS 2.0

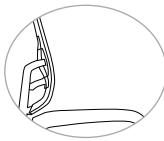

EFFECTIVE DECEMBER 1, 2021 | GSA SIN #: 33721

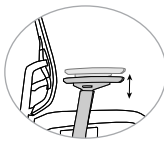
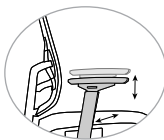
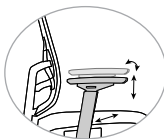
## 4. Arms

Arm Style	Code	Price	
Armless	AR0	- \$48	
Fixed Arms	AR2	- \$10	
Height-Adjustable	AR4	+ \$0	
Height-/Width-Adjustable (4-Way)	AR6	+ \$25	
Fully Adjustable (8-Way)	AR9	+ \$60	

Arms, if specified, come with fog arm pads for the white (FC12) and fog (FC13) frames and black arm pads for the black frame (FC1).

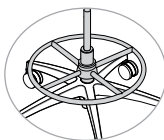
## 5. Base

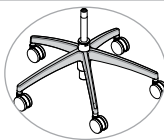
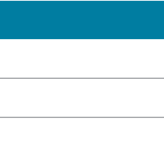
Base	Code	Price	
Stool Kit	S1	+ \$0	
Extended Stool Kit	S2	+ \$24	
Base Style	Code	Price	
5-Star Nylon	BT1	+ \$0	
5-Star Polished Aluminum	BT2	+ \$113	
Nylon Base Color	Code	Price	
Black Nylon Base	BC1	+ \$0	
Fog Nylon Base	BC4	+ \$0	
White Nylon Base	BC3	+ \$0	

## MESH BACK TASK STOOL

## 5. Base (Cont.)

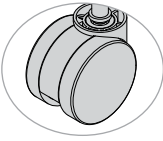
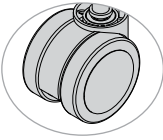
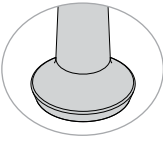
Casters or Glides	Code	Price	
<b>Casters</b>			
Carpet Casters	CS5	+ \$0	
Hard Floor and Carpet Casters	CS6	+ \$40	
<b>Glides</b>			
Glides for Task Chairs	CS3	+ \$30	

## 6. Material

Mesh	Code	Price	
<b>Focus 2.0 Mesh</b>			
Apple	MC31	+ \$0	
Desert	MC9	+ \$0	
Electric Blue	MC13	+ \$0	
Fire	MC10	+ \$0	
Fog	MC7	+ \$0	
Navy	MC8	+ \$0	
Nickel	MC6	+ \$0	
Ocean	MC29	+ \$0	
Onyx	MC5	+ \$0	
Tangerine	MC28	+ \$0	
<b>Focus 2.0 Uptown Mesh</b>			
Midnight	MC43	+ \$0	
Charcoal	MC44	+ \$0	
Ash	MC45	+ \$0	
Dune	MC46	+ \$0	
<b>Focus Mesh</b>			
Black	MC1	+ \$0	
Sand	MC3	+ \$0	
Slate	MC2	+ \$0	
Freeway Sport Stripe (Black/Slate)	MC33	+ \$0	
Impress Sport Stripe (Slate/Black)	MC34	+ \$0	

*Sport striped meshes list the predominant color first.*

## 6. Material (Cont.)

Seat Textile	Code	Price
Fabric/Vinyl Grade 1	FG1/VG1	+ \$0
COM	COM	+ \$26
Fabric/Vinyl Grade 2	FG2/VG2	+ \$26
Fabric/Vinyl Grade 3	FG3/VG3	+ \$60
Fabric/Vinyl Grade 4	FG4/VG4	+ \$116
Fabric/Vinyl Grade 5	FG5/VG5	+ \$172
Fabric/Vinyl Grade 6	FG6/VG6	+ \$213
Fabric/Vinyl Grade 7	FG7/VG7	+ \$254
Leather Grade 1	LG1	+ \$300
COL	COL	+ \$380
Leather Grade 2	LG2	+ \$380
Leather Grade 3	LG3	+ \$480

Please reference the *Textile Reference Guide* for pricing on fabric over grade 7 and leather over grade 3.

## 7. Packaging

Mesh	Code	Price
Knocked Down	KD	+ \$0
Back Attached to Seat, Base Separate	UC	+ \$80
Fully Assembled in a Carton	AC	+ \$200

## MESH BACK TASK STOOL

### SPECIFICATIONS

	1123 BK1 MB S1 Task Stool	1123 BK1 MB S2 Extended Task Stool
<b>Dimensions</b>		
Overall Width Without Arms	26"	26"
Overall Width With Arms	28.75"	28.75"
Overall Depth	28"	28"
Overall Height	40"-49.5"	43"-52.5"
Seat Width	19.6"	19.6"
Seat Depth	18.25"	18.25"
Seat Height	22.5"-32"	25.5"-35"
Back Width	18.25"	18.25"
Back Height	19.5"	19.5"
<b>Materials</b>		
COM	1 yd	1 yd
COL	14 sq ft	14 sq ft
<b>Weight and Capacity</b>		
Weight Armless	32.2 lb	33.2 lb
Weight With Arms	37 lb	38 lb
Weight Capacity Warranty	300 lb	300 lb

Swivel-tilt mechanism (T). Enhanced synchro mechanism (Y).

# Glove Active

## CONFERENCE CHAIR

### *The lap of luxury.*

The Glove™ Active is a luxurious leadership chair that combines pillow-top padding with classic tufted leather seating. It boasts an abundance of foam padding and folds of leather. Available with four mechanism choices, four adjustable arm styles, and optional seat-depth adjustment, Glove Active raises the bar for flexibility and control. It's a luxurious choice for guest and task seating in an executive suite, boardroom or behind a manager's desk.



EFFECTIVE DECEMBER 1, 2021

## Featured Models

### **GOOD :: \$1,457**

Midback, swivel-tilt mechanism, loop arms, nylon base, grade 1 leather

### **BETTER :: \$1,894**

Highback, enhanced synchro mechanism, height-adjustable arms, nylon base, grade 2 leather

### **BEST :: \$2,167**

Highback, multi-function mechanism with seat depth adjustment, height-/width-adjustable arms with pivot, brushed aluminum base, grade 2 leather

# GLOVE ACTIVE

EFFECTIVE DECEMBER 1, 2021 | GSA SIN #: 33721

## Features

- Pillow top
- Midback or highback
- Waterfall seat
- 250 lb weight capacity warranty;  
350 lb Heavy Duty weight capacity warranty

### 1. Back

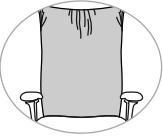
Back Size and Style	Code	Price	
Midback	7531	\$1,322	
Highback	7532	\$1,354	

### 2. Heavy Duty

Heavy Duty Series	Code	Price	
Heavy Duty	HD	+ \$126	

Heavy duty option not available with swivel-tilt (T) mechanism. See page 536 for additional LT and HD options.

## CONFERENCE CHAIR

### 3. Mechanism

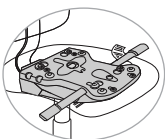
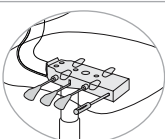
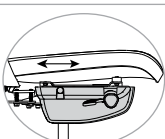
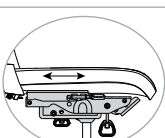
Mechanism	Code	Price	
Swivel-Tilt	T	- \$90	
Enhanced Synchro	Y	+ \$0	
Multi-Function	M	+ \$36	
Enhanced Synchro With Seat-Depth Adjustment	Y E3	+ \$79	
Multi-Function With Seat-Depth Adjustment	M E3	+ \$115	



Good

# GLOVE ACTIVE



EFFECTIVE DECEMBER 1, 2021 | GSA SIN #: 33721

## 4. Arms

Arm Style	Code	Price	
Armless	A0	- \$90	
Fixed Loop	A26	- \$15	
Height-Adjustable	A27-L	+ \$0	
Height-Adjustable With Pivot	A27	+ \$10	
Height-/Width-Adjustable	A28-L	+ \$25	
Height-/Width-Adjustable With Pivot	A28	+ \$45	
Upholstered Cap Loop	A41	+ \$93	

Heavy Duty (HD) option not available with fixed loop arms (A26) or upholstered cap loop arms (A41).

## 5. Base

Base Color and Material	Code	Price	
Black Nylon Base	B0	+ \$0	
Heavy Duty Black Nylon Base, 26" (For HD)	B7	+ \$0	
Brushed Aluminum Base	B2	+ \$113	

Aluminum base (B2) not available with seat-depth adjustment (E3).

## CONFERENCE CHAIR

### 5. Base (Cont.)

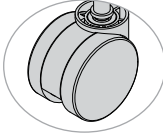
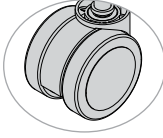
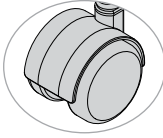
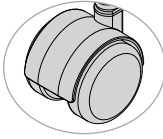
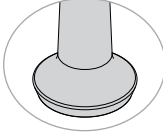
Casters or Glides	Code	Price	
<b>Casters</b>			
Black Carpet Casters	C11	+ \$0	
Black Hard Floor and Carpet Casters	C9	+ \$40	
Self-Locking Carpet Casters	C2	+ \$30	
Self-Locking Hard Floor and Carpet Casters	C7	+ \$61	
<b>Glides</b>			
Glides for Task Chairs	C3	+ \$30	

Self-locking casters (C2/C7) lock only when not in use. Self-locking casters not available for Heavy Duty series.

## 6. Material

Ballistic Nylon	Code	Price	
Ballistic Nylon Back	BN	+ \$0	
None	N	+ \$0	
Seat and Back Textile	Code	Price	
Fabric/Vinyl Grade 1	FG1/VG1	+ \$0	
COM	COM	+ \$40	
Fabric/Vinyl Grade 2	FG2/VG2	+ \$40	
Fabric/Vinyl Grade 3	FG3/VG3	+ \$84	
Fabric/Vinyl Grade 4	FG4/VG4	+ \$156	
Fabric/Vinyl Grade 5	FG5/VG5	+ \$228	
Fabric/Vinyl Grade 6	FG6/VG6	+ \$304	
Fabric/Vinyl Grade 7	FG7/VG7	+ \$378	
Leather Grade 1	LG1	+ \$240	
COL	COL	+ \$540	
Leather Grade 2	LG2	+ \$540	
Leather Grade 3	LG3	+ \$820	
Leather/Ballistic Grade 2	BN2	+ \$379	
Leather/Ballistic Grade 3	BN3	+ \$631	

Please reference the *Textile Reference Guide* for pricing on fabric over grade 7 and leather over grade 3.

Note: Due to the alignment between chair panels, the chairs ordered in a textile will ship with a black spacer mesh outer back. Chairs ordered in vinyl or leather ship fully upholstered in the finish selected.

## 7. Packaging

Packaging	Code	Price	
Back Attached to Seat, Base Separate	UC	+ \$0	
Fully Assembled in a Carton	AC	+ \$120	

## CONFERENCE CHAIR

### SPECIFICATIONS

	7531 Midback Chair	7532 Highback Chair
<b>Dimensions</b>		
Overall Width	27.75"	27.75"
Overall Depth	25"	25"
Overall Height	40" (T) 40.5 (Y/M)	43" (T) 43.5 (Y/M)
With Aluminum Base	40.5" (T/B2) 41" (Y/M/B2)	43.5" (T/B2) 44" (Y/M/B2)
Seat Width	19.75"	19.75"
Seat Depth	17"	18"
Seat Height	16.25"-20.75" (T) 16.5"-20" (Y) 16.5"-21" (M)	16.25"-20.75" (T) 16.5"-20" (Y) 16.5"-21" (M)
With Aluminum Base	16.75"-21.25" (T) (B2) 17"-20.5" (Y) (B2) 17"-21.5" (M) (B2)	16.75"-21.25" (T) (B2) 17"-20.5" (Y) (B2) 17"-21.5" (M) (B2)
Back Width	23"	23"
Back Height	19.5"	22.5"
<b>Materials</b>		
COM	2.4 yd 1.25 yd (BN)	2.5 yd 1.4 yd (BN)
COL	50 sq ft 36 sq ft (BN)	55 sq ft 42 sq ft (BN)
<b>Weight and Capacity</b>		
Weight	56 lb (T) 63 lb (Y) 64 lb (M)	59 lb (T) 66 lb (Y) 67 lb (M)
Weight Capacity Warranty	250 lb 350 lb (HD)	250 lb 350 lb (HD)

Swivel-tilt mechanism (T). Enhanced synchro mechanism (Y). Heavy duty (HD). Multi-function mechanism (M). Ballistic nylon back (BN). Brushed aluminum base (B2)

# Glove Executive

## CONFERENCE CHAIR

### *The lap of luxury.*

The Glove™ Executive is a luxurious leadership chair that combines pillow-top padding with classic tufted leather seating. Boasting an abundance of foam padding and folds of leather, Glove is the seat of comfort for the head of a boardroom conference table or the corner office.



Best

EFFECTIVE DECEMBER 1, 2021

### Featured Models

#### **GOOD :: \$1,613**

Midback, swivel-tilt mechanism, loop arms, nylon base, grade 1 leather

#### **BETTER :: \$1,646**

Midback, knee-tilt mechanism, loop arms, nylon base, grade 1 leather

#### **BEST :: \$2,091**

Highback, knee-tilt mechanism, loop arms, brushed aluminum base, grade 2 leather

# GLOVE EXECUTIVE

EFFECTIVE DECEMBER 1, 2021 | GSA SIN #: 33721

## Features

- Pillow top
- Midback or highback
- Optional button detail
- Waterfall seat
- 250 lb weight capacity warranty;  
350 lb Heavy Duty weight capacity warranty

### 1. Back

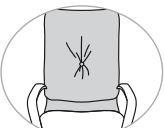
Back Size and Style	Code	Price	
Midback	7541	\$1,406	
Highback	7542	\$1,438	

Back Options	Code	Price	
Remove Button	RB	+ \$0	

### 2. Mechanism

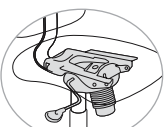

Mechanism	Code	Price	
Swivel-Tilt	T	- \$33	
Knee-Tilt	K	+ \$0	



## CONFERENCE CHAIR

### 3. Arms

Arm Style	Code	Price	
Fixed Loop	A26	+ \$0	

### 4. Base

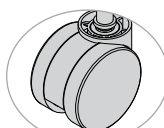
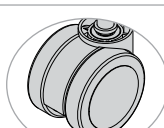
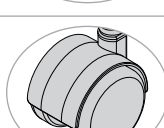
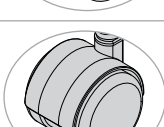
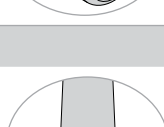
Base Color and Material	Code	Price	
Black Nylon Base	B0	+ \$0	
Brushed Aluminum Base	B2	+ \$113	

Casters or Glides	Code	Price	
<b>Casters</b>			
Carpet Casters	C5	+ \$0	
Black Carpet Casters (For Brushed Aluminum Base B2)	C11	+ \$0	
Hard Floor and Carpet Casters	C1	+ \$40	
Black Hard Floor and Carpet Casters (For Brushed Aluminum Base B2)	C9	+ \$61	
Self-Locking Carpet Casters	C2	+ \$30	
Self-Locking Hard Floor and Carpet Casters	C7	+ \$61	
<b>Glides</b>			
Glides for Task Chairs	C3	+ \$30	

*Self-locking casters (C2/C7) lock only when not in use.*



# GLOVE EXECUTIVE

EFFECTIVE DECEMBER 1, 2021 | GSA SIN #: 33721

## 5. Material

Ballistic Nylon Back	Code	Price
Ballistic Nylon Back	BN	+ \$0
None	N	+ \$0
Seat and Back Textile	Code	Price
Fabric/Vinyl Grade 1	FG1/VG1	+ \$0
COM	COM	+ \$40
Fabric/Vinyl Grade 2	FG2/VG2	+ \$40
Fabric/Vinyl Grade 3	FG3/VG3	+ \$84
Fabric/Vinyl Grade 4	FG4/VG4	+ \$156
Fabric/Vinyl Grade 5	FG5/VG5	+ \$228
Fabric/Vinyl Grade 6	FG6/VG6	+ \$304
Fabric/Vinyl Grade 7	FG7/VG7	+ \$378
Leather Grade 1	LG1	+ \$240
COL	COL	+ \$540
Leather Grade 2	LG2	+ \$540
Leather Grade 3	LG3	+ \$820
Leather/Ballistic Grade 2	BN2	+ \$379
Leather/Ballistic Grade 3	BN3	+ \$631

Please reference the *Textile Reference Guide* for pricing on fabric over grade 7 and leather over grade 3.

Note: Due to the alignment between chair panels, the chairs ordered in a textile will ship with a black spacer mesh outer back. Chairs ordered in vinyl or leather ship fully upholstered in the finish selected.



Good

## CONFERENCE CHAIR

### 6. Packaging

Packaging	Code	Price
Back Attached to Seat, Base Separate	UC	+ \$0

### SPECIFICATIONS

	7541 Midback Conference	7542 Highback Conference
<b>Dimensions</b>		
Overall Width	24.5"	24.5"
Overall Depth	27"	27"
Overall Height	42" (B0) 42.5" (B2)	48" (B0) 48.5" (B2)
Seat Width	20.5"	20.5"
Seat Depth	20"	20"
Seat Height With Aluminum Base	16.5"-21" (B0) 17"-21.5" (B2)	16.5"-21" (B0) 17"-21.5" (B2)
Back Width	22.75"	22.75"
Back Height	21"	27"
<b>Materials</b>		
COM	3.25 yd 2.15 yd (BN)	3.5 yd 2.35 yd (BN)
COL	56 sq ft 44 sq ft (BN)	70 sq ft 57 sq ft (BN)
<b>Weight and Capacity</b>		
Weight	61 lb (T) 64 lb (K)	69 lb (T) 72 lb (K)
Weight Capacity	250 lb	250 lb

Swivel-tilt mechanism (T). Knee-tilt mechanism (K). Ballistic nylon back (BN). Black nylon base (B0) Brushed aluminum base (B2)

# Hexy

## TASK AND CONFERENCE CHAIR

### *Powered by fusion.*

Hexy is what happens when you let inspiration drive innovation—and engineer ergonomics right into the frame. Its hexagon core creates natural support so there's no need for external lumbar controls, and the high-performing mesh fuses with the extra-wide backrest seamlessly. It's the ultimate seat for action-packed (and comfort-backed) environments.



EFFECTIVE DECEMBER 1, 2021

### Featured Models

#### **GOOD :: \$451**

Midback task chair, black frame, swivel-tilt mechanism, fixed arms, nylon base, standard cylinder, carpet casters, grade 1 textile

#### **BETTER :: \$497**

Highback task chair, black frame, standard synchro mechanism, height-adjustable arms, standard cylinder, carpet casters, grade 1 textile



#### **BEST :: \$641**

Highback task chair, white frame, standard synchro mechanism with seat-depth adjustment, height-/width-adjustable (4-way) arms, standard cylinder, carpet casters, grade 1 textile

## Features

- Extra-wide backrest with innovative hexagon core provides integrated ergonomics
- Ultra-supportive performance mesh seamlessly fuses with a lightweight frame
- Aerodynamic arms and pull-handle offer active comfort and convenience
- Multiple mesh, frame arm and mechanism option let you customize endlessly

### 1. Back and Seat

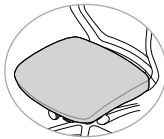

Back Size and Style	Code	Price	
Midback Mesh	1203 BK1 MB	\$469	
Highback Mesh	1203 BK2 MB	\$497	

Seat	Code	Price	
Upholstered Seat	US	+\$0	

## TASK AND CONFERENCE CHAIR

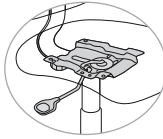

### 2. Mechanism

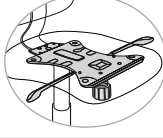
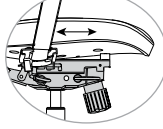
Back Size and Style	Code	Price	
Basic	B	-\$33	
Swivel Tilt	T	-\$18	
Standard Synchro	F	+\$0	
Standard Synchro With Seat-Depth Adjustment	F/E3	+\$79	

### 3. Frame

Frame Color	Code	Price	
Black	FC1	+\$0	
Fog	FC13	+\$35	
White	FC12	+\$35	

### 4. Arms

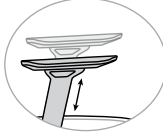
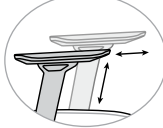
Arm Style	Code	Price	
Armless	AR0	-\$48	
Fixed Arm	AR2	-\$10	
Height-Adjustable	AR4	+\$0	
Height/Width Adjustable (4-Way)	AR6	+\$30	

## 5. Base

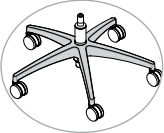
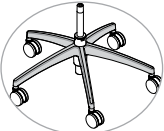
Base Style	Code	Price	
5-Star Nylon	BT1	+ \$0	
5-Star Polished Aluminum	BT2	+ \$113	

Base Color	Code	Price	
Black Nylon Base	BC1	+ \$0	
Fog Nylon Base	BC4	+ \$0	
White Nylon Base	BC3	+ \$0	

Cylinder Height	Code	Price	
Standard Cylinder	CH1	+ \$0	
Higher Cylinder	CH3	+ \$0	

Casters or Glides	Code	Price	
<b>Casters</b>			

Carpet Casters	CS5	+ \$0	
Hard Floor and Carpet Casters	CS6	+ \$40	

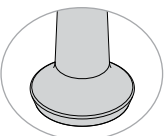
<b>Glides</b>			
Glides for Task Chairs	CS3	+ \$30	

The higher cylinder (CH3) is only available with the black base regardless of frame color.

## TASK AND CONFERENCE CHAIR

## 6. Material

Mesh Color	Code	Price	
Apple	MC31	+ \$0	
Desert	MC22	+ \$0	
Electric Blue	MC24	+ \$0	
Fire	MC25	+ \$0	
Fog	MC23	+ \$0	
Navy	MC8	+ \$0	
Nickel	MC21	+ \$0	
Ocean	MC29	+ \$0	
Onyx	MC20	+ \$0	
Tangerine	MC28	+ \$0	

Seat Textile	Code	Price	
Fabric/Vinyl Grade 1	FG1/VG1	+ \$0	
COM	COM	+ \$26	
Fabric/Vinyl Grade 2	FG2/VG2	+ \$26	
Fabric/Vinyl Grade 3	FG3/VG3	+ \$60	
Fabric/Vinyl Grade 4	FG4/VG4	+ \$116	
Fabric/Vinyl Grade 5	FG5/VG5	+ \$172	
Fabric/Vinyl Grade 6	FG6/VG6	+ \$213	
Fabric/Vinyl Grade 7	FG7/VG7	+ \$254	
Leather Grade 1	LG1	+ \$300	
COL	COL	+ \$380	
Leather Grade 2	LG2	+ \$380	
Leather Grade 3	LG3	+ \$480	

Please reference the *Textile Reference Guide* for pricing on fabric over grade 7 and leather over grade 3.

## 7. Packaging

Packaging	Code	Price	
Knocked Down	KD	+ \$0	
Back Attached to Seat, Base Separate	UC	+ \$80	
Fully Assembled in a Carton	AC	+ \$200	

### SPECIFICATIONS

	1203 BK1 MB Midback Mesh	1203 BK2 MB Highback Mesh
<b>Dimensions</b>		
Overall Width Without Arms	26.25"	26.25"
Overall Width With Arms	26.25"	26.25"
Overall Depth	27"	27"
Overall Height	36.5"	39.5"
Seat Width	20"	20"
Seat Depth	17"-19"	17"-19"
Seat Height	16"-19.75" (B, CH1)	16"-19.75" (B, CH1)
	16.25"-20" (T, CH1)	16.25"-20" (T, CH1)
	16.75"-20.25" (F, CH1)	16.75"-20.25" (F, CH1)
	17"-20.625" (F/E3, CH1)	17"-20.625" (F/E3, CH1)
	16.25"-21.25" (B, CH3)	16.25"-21.25" (B, CH3)
	16.5"-21.5" (T, CH3)	16.5"-21.5" (T, CH3)
	17"-22" (F, CH3)	17"-22" (F, CH3)
	17.25"-22.25" (F/E3, CH3)	17.25"-22.25" (F/E3, CH3)
Back Width	19.25"	19.5"
Back Height	19.25"	22.25"
<b>Materials</b>		
COM	1 yd	1 yd
COL	17 sq ft	17 sq ft
<b>Weight and Capacity</b>		
Weight Armless	32 lb	33 lb
Weight With Arms	38 lb	39 lb
Weight Capacity	300 lb	300 lb

*Basic mechanism (B). Swivel-tilt mechanism (T). Standard synchro mechanism (F). Standard synchro mechanism with seat-depth adjustment (F/E3). Standard cylinder (CH1). Higher cylinder (CH3).*



Best

# Hexy

## MESH BACK TASK STOOL

### *Powered by fusion.*

Hexy is what happens when you let inspiration drive innovation—and engineer ergonomics right into the frame. Its hexagon core creates natural support so there's no need for external lumbar controls, and the high-performing mesh fuses with the extra-wide backrest seamlessly. It's the ultimate seat for action-packed (and comfort-backed) environments.



**EFFECTIVE DECEMBER 1, 2021**

### Featured Models

#### **GOOD :: \$536**

Midback task stool, basic mechanism, black frame, armless, standard stool kit, nylon base, carpet casters, grade 1 textile

#### **BETTER :: \$581**

Midback task stool, basic mechanism, fog frame, height-adjustable arms, standard stool kit, nylon base, carpet casters, grade 1 textile,

#### **BEST :: \$748**

Midback task stool, basic mechanism, white frame, height-/width-adjustable (4-way) arms, extended stool kit, polished aluminum base, carpet casters, grade 1 textile,

## Features

- Extra-wide backrest with innovative hexagon core provides integrated ergonomics
- Ultra-supportive performance mesh seamlessly fuses with a lightweight frame
- Aerodynamic arms and pull-handle offer active comfort and convenience
- Multiple mesh, frame arm and mechanism option let you customize endlessly

### 1. Back and Seat

Back Size and Style	Code	Price	
Midback Mesh	1203 BK1 MB	\$546	

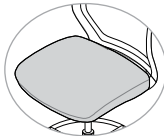
Seat	Code	Price	
Upholstered Seat	US	+\$0	

### 2. Mechanism

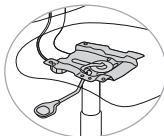
Back Size and Style	Code	Price	
Basic	B	+\$0	

### 3. Frame

Frame Color	Code	Price	
Black	FC1	+\$0	
Fog	FC13	+\$35	
White	FC12	+\$35	

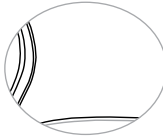
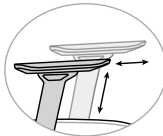

## TASK STOOL

### 4. Arms

Arm Style	Code	Price	
Armless	AR0	-\$48	
Fixed Arm	AR2	-\$10	
Height-Adjustable	AR4	+\$0	
Height/Width Adjustable (4-Way)	AR6	+\$30	

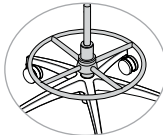
### 5. Base

Base	Code	Price	
Stool Kit	S1	+\$0	
Extended Stool Kit	S2	+\$24	

Base Style	Code	Price	
5-Star Nylon	BT1	+\$0	
5-Star Polished Aluminum	BT2	+\$113	

Base Color	Code	Price	
Black Nylon Base	BC1	+\$0	
Fog Nylon Base	BC4	+\$0	
White Nylon Base	BC3	+\$0	

## 5. Base Cont.)

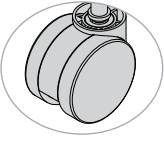
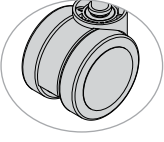
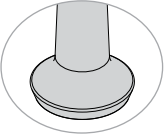
Casters or Glides	Code	Price	
<b>Casters</b>			
Carpet Casters	CS5	+ \$0	
Hard Floor and Carpet Casters	CS6	+ \$40	
<b>Glides</b>			
Glides for Task Chairs	CS3	+ \$30	

The higher cylinder (CH3) is only available with the black base regardless of frame color.

## 6. Material

Mesh Color	Code	Price	
Apple	MC31	+ \$0	
Desert	MC22	+ \$0	
Electric Blue	MC24	+ \$0	
Fire	MC25	+ \$0	
Fog	MC23	+ \$0	
Navy	MC8	+ \$0	
Nickel	MC21	+ \$0	
Ocean	MC29	+ \$0	
Onyx	MC20	+ \$0	
Tangerine	MC28	+ \$0	

## TASK STOOL

## 6. Material (Cont.)

Seat Textile	Code	Price	
Fabric/Vinyl Grade 1	FG1/VG1	+ \$0	
COM	COM	+ \$26	
Fabric/Vinyl Grade 2	FG2/VG2	+ \$26	
Fabric/Vinyl Grade 3	FG3/VG3	+ \$60	
Fabric/Vinyl Grade 4	FG4/VG4	+ \$116	
Fabric/Vinyl Grade 5	FG5/VG5	+ \$172	
Fabric/Vinyl Grade 6	FG6/VG6	+ \$213	
Fabric/Vinyl Grade 7	FG7/VG7	+ \$254	
Leather Grade 1	LG1	+ \$300	
COL	COL	+ \$380	
Leather Grade 2	LG2	+ \$380	
Leather Grade 3	LG3	+ \$480	

Please reference the *Textile Reference Guide* for pricing on fabric over grade 7 and leather over grade 3.

## 7. Packaging

Packaging	Code	Price	
Knocked Down	KD	+ \$0	
Back Attached to Seat, Base Separate	UC	+ \$80	
Fully Assembled in a Carton	AC	+ \$200	



## TASK STOOL

### SPECIFICATIONS

	1203 BK1 MB S1 Task Stool	1203 BK1 MB S2 Extended Task Stool
<b>Dimensions</b>		
Overall Width Without Arms	26.25"	26.25"
Overall Width With Arms	26.25"	26.25"
Overall Depth	27"	27"
Overall Height	41.875"	44.75"
Seat Width	20"	20"
Seat Depth	17"	17"
Seat Height	21.375"-29"	24.25"- 34.25"
Back Width	19.25"	19.25"
Back Height	19.25"	19.25"
<b>Materials</b>		
COM	1 yd	1 yd
COL	17 sq ft	17 sq ft
<b>Weight and Capacity</b>		
Weight Armless	30 lb	31 lb
Weight With Arms	36 lb	37 lb
Weight Capacity	300 lb	300 lb



# InFlex

## LIGHT TASK CHAIR AND TASK STOOL

### *Geometry in motion.*

The InFlex™ light task chair and stool deliver task functionality with fun styling. Designer Giancarlo Piretti fused design and engineering to create the flexback disc system that follows the spine's natural curve. A stylish, comfortable and affordable standout in a creative office space or anywhere collaboration is called for.



**EFFECTIVE DECEMBER 1, 2021**

### Featured Models

**GOOD :: \$471**

All plastic seat and back, basic mechanism, armless, carpet casters

**BETTER :: \$529**

Plastic back, upholstered seat, basic mechanism, armless, carpet casters, grade 1 textile



**BEST :: \$645**

Upholstered seat and back, basic mechanism, fixed task arms, carpet casters, grade 1 textile

## Features



- Giancarlo Piretti design
- Innovative disc system emulates the human spine
- Fully upholstered, upholstered seat or plastic
- Nine plastic colors
- Two frame finishes
- CAL 133 approved models
- 300 lb weight capacity warranty
- Complements InFlex multipurpose chair, counter and bar stool; see page 218

### 1. Back

Back and Seat Style	Code	Price	
Plastic	No Code	\$471	
Upholstered Seat	US	\$529	
Upholstered Seat and Back	UP	\$587	

## LIGHT TASK CHAIR AND TASK STOOL

### 2. Frame



Frame Type	Code	Price	
Task Chair	973B	+ \$0	
Task Stool	973B S1	+ \$132	
Extended Task Stool	973B S2	+ \$156	

Frame Finish	Code	Price	
Black	FC1	+ \$0	
Silver	FC2	+ \$0	

*InFlex task models come with basic mechanism (swivel only).*

### 3. Arms

Arm Style	Code	Price	
Armless	A0	+ \$0	
Fixed Task Arms	A122	+ \$58	

## 4. Base

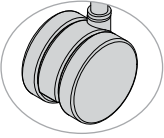
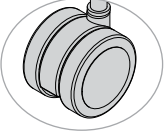
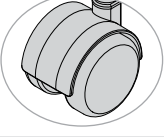
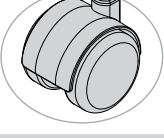
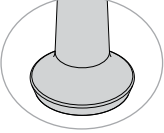
Casters or Glides	Code	Price	
<b>Casters</b>			
Carpet Casters	C15	+ \$0	
Hard Floor and Carpet Casters	C14	+ \$40	
Self-Locking Carpet Casters	C20	+ \$30	
Self-Locking Hard Floor and Carpet Casters	C19	+ \$64	
<b>Glides</b>			
Glides for Task Chairs	C3	+ \$30	

Self-locking casters (C19/C20) lock only when not in use.

## LIGHT TASK CHAIR AND TASK STOOL

## 5. Material

Protection	Code	Price	
<b>Fire Retardancy</b>			
CAL 133, Fabric, Quantities 1-49	133F	+ \$99	
CAL 133, Fabric, Quantities 50+	133F5	+ \$55	
CAL 133, Plastic, Any Quantity	133P	+ \$45	
Shell Color	Code	Price	
Arctic	SC21	+ \$0	
Black	SC1	+ \$0	
Chocolate	SC4	+ \$0	
Lagoon	SC15	+ \$0	
Latte	SC20	+ \$0	
Navy	SC5	+ \$0	
Red	SC19	+ \$0	
Slate	SC8	+ \$0	
Sterling	SC18	+ \$0	
Textile	Code	Price	
<b>Seat Textile Only (For US)</b>			
Fabric/Vinyl Grade 1	FG1/VG1	+ \$0	
COM	COM	+ \$22	
Fabric/Vinyl Grade 2	FG2/VG2	+ \$22	
Fabric/Vinyl Grade 3	FG3/VG3	+ \$45	
Fabric/Vinyl Grade 4	FG4/VG4	+ \$77	
Fabric/Vinyl Grade 5	FG5/VG5	+ \$116	
Fabric/Vinyl Grade 6	FG6/VG6	+ \$159	
Fabric/Vinyl Grade 7	FG7/VG7	+ \$200	
<b>Seat and Back Textile (For UP)</b>			
Fabric/Vinyl Grade 1	FG1/VG1	+ \$0	
COM	COM	+ \$34	
Fabric/Vinyl Grade 2	FG2/VG2	+ \$34	
Fabric/Vinyl Grade 3	FG3/VG3	+ \$74	
Fabric/Vinyl Grade 4	FG4/VG4	+ \$121	
Fabric/Vinyl Grade 5	FG5/VG5	+ \$174	
Fabric/Vinyl Grade 6	FG6/VG6	+ \$235	
Fabric/Vinyl Grade 7	FG7/VG7	+ \$296	

Please reference the *Textile Reference Guide* for pricing on fabric over grade 7. Additional CAL 133 information can be found on page 10.

EFFECTIVE DECEMBER 1, 2021 | GSA SIN #: 33721

### 6. Packaging

Packaging	Code	Price
Back Attached to Seat, Base Separate	UC	+ \$0

### SPECIFICATIONS

	973B Task Chair	973B S1 Task Stool	973B S2 Extended Task Stool
<b>Dimensions</b>			
Overall Width Armless	19.75"	19.75"	19.75"
Overall Width With Arms	25"	25"	25"
Overall Depth	22.25"	22.25"	22.25"
Overall Height	32.5"	38.5"	42.5"
Seat Width	16.75"	16.75"	16.75"
Seat Depth	18.5"	18.5"	18.5"
Seat Height	16.5"-21.5"	20"-28"	24.5"-34.5"
Back Width	19.75"	19.75"	19.75"
Back Height	15.5"	15.5"	15.5"
<b>Materials</b>			
COM	0.85 yd (US) 1 yd (UP)	0.85 yd (US) 1 yd (UP)	0.85 yd (US) 1 yd (UP)
COL	10 sq ft (US) 15 sq ft (UP)	10 sq ft (US) 15 sq ft (UP)	10 sq ft (US) 15 sq ft (UP)
<b>Weight and Capacity</b>			
Weight Armless	15 lb	16.5 lb	16.5 lb
Weight With Arms	19 lb	20.5 lb	20.5 lb
Weight Capacity Warranty	300 lb	300 lb	300 lb

*Upholstered seat only (US). Upholstered seat and back (UP).*



Best

# Ioniq

## COLLABORATIVE CHAIR

### *Inspire unique.*

There's a specialness that flows through Ioniq™. Its form and feeling are fluid—from the way the arms stretch seamlessly out of a sculpted shell to base options that are as varied and versatile as the spaces they occupy. Because when you desire aesthetics that elevate any experience and offer something refreshingly different, there's only one go-to. And that's Ioniq.



**EFFECTIVE DECEMBER 1, 2021**

### Featured Models

#### **GOOD :: \$752**

Plastic back, upholstered seat, integrated arms, height-adjustable mechanism with swivel and tilt, 5-star nylon base, carpet casters, grade 1 textile

#### **BETTER :: \$865**



Plastic back, upholstered seat, integrated arms, height-adjustable mechanism with swivel and tilt, 5-star polished aluminum, carpet casters, grade 1 textile

## COLLABORATIVE CHAIR

### Features

- Breathable back with built-in lumbar support
- Minimalist-designed mechanism with streamlined controls
- Edge-to-edge cushion
- Fully integrated armrests
- Single-piece sculpted shell
- 5-star base
- Performance casters
- 300 lb weight capacity warranty
- Complements Ioniq Guest and Ioniq Side; see page 222 and page 224

#### 1. Frame

Frame Type	Code	Price	
Collaborative Task (5-Star Base)	1152 FT3	\$752	
Seat and Back Style	Code	Price	
Plastic Back With Upholstered Seat Pad	US PB	+ \$0	
Shell Color	Code	Price	
Black	SC1	+ \$0	
White	SC26	+ \$0	

#### 2. Base

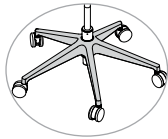
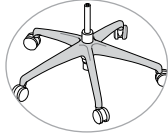
Base Type and Material	Code	Price	
5-Star Nylon	BT1	+ \$0	
5-Star Polished Aluminum	BT2	+ \$113	

#### 2. Base (Cont.)

Base Color	Code	Price	
Black Nylon Base	BC1	+ \$0	
White Nylon Base	BC3	+ \$0	
Casters or Glides	Code	Price	
Carpet Casters	CS5	+ \$0	
Hard Floor and Carpet Casters	CS6	+ \$40	

Black nylon base (BC1) available with black shell (SC1) only. White nylon base (BC3) available with white shell (SC26) only.

Caster color will correspond to shell color.

#### 3. Mechanism

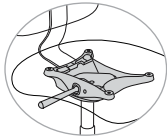
Mechanism	Code	Price	
Height-Adjustable With Swivel and Tilt	T	+ \$0	

#### 4. Material

Seat Textile	Code	Price	
Fabric/Vinyl Grade 1	FG1/VG1	+ \$0	
COM	COM	+ \$22	
Fabric/Vinyl Grade 2	FG2/VG2	+ \$22	
Fabric/Vinyl Grade 3	FG3/VG3	+ \$45	
Fabric/Vinyl Grade 4	FG4/VG4	+ \$77	
Fabric/Vinyl Grade 5	FG5/VG5	+ \$116	
Fabric/Vinyl Grade 6	FG6/VG6	+ \$159	
Fabric/Vinyl Grade 7	FG7/VG7	+ \$200	
Leather Grade 1	LG1	+ \$140	
COL	COL	+ \$200	
Leather Grade 2	LG2	+ \$200	
Leather Grade 3	LG3	+ \$280	

Please reference the Textile Reference Guide for pricing on fabric over grade 7 and leather over grade 3.

COLLABORATIVE CHAIR

5. Packaging

Packaging	Code	Price
Back Attached to Seat, Base Separate	UC	+ \$0
Fully Assembled in a Carton	AC	+ \$120

SPECIFICATIONS

	1152 FT3 Collaborative Chair
<b>Dimensions</b>	
Overall Width	28"
Overall Depth	28"
Overall Height	33.75"-37.5"
Seat Width	17.5"
Seat Depth	17.38"
Seat Height	17.5"-21.25"
Back Width	18"
Back Height	17.38"
<b>Materials</b>	
COM	0.75 yd
COL	7 sq ft
<b>Weight and Capacity</b>	
Weight	18.5 lb
Weight Capacity Warranty	300 lb

Chair is widest at the base.





# Knack

## TASK CHAIR

### *Smart choice. Everyday.*

Knack™ boasts an uncluttered and traditional design that makes it an essential and affordable choice for corporate, healthcare, government and educational settings. The soft, comfortable back follows the natural curve of the spine, providing great support for hours of sitting. Five control selections and a Heavy Duty 24/7 option make Knack a great all-around task chair. Knack includes a back-height adjustment so every user can enjoy individualized upper-back and lumbar support.



EFFECTIVE DECEMBER 1, 2021

### Featured Models

#### **GOOD :: \$687**

Swivel-tilt mechanism, height-adjustable arms, nylon base, grade 1 textile

#### **BETTER :: \$777**

Enhanced synchro mechanism, height-adjustable arms, nylon base, grade 1 textile

#### **BEST :: \$881**

Enhanced synchro mechanism, height-/width-adjustable arms, seat-depth adjustment, nylon base, grade 1 textile

### Features

- Durable and ergonomic
- Internal back-height adjustment (on Y and M mechanisms only)
- Ballistic nylon back (optional)
- Brushed aluminum, polished aluminum or nylon base
- Waterfall seat
- 300 lb weight capacity warranty;  
350 lb Heavy Duty weight capacity warranty

#### 1. Back

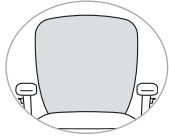
Back Size and Style	Code	Price	
Midback Task Chair	3323	\$777	

#### 2. Heavy Duty

Heavy Duty Series	Code	Price	
Heavy Duty	HD	+ \$126	

Must select multi-function (M) or enhanced synchro (Y) mechanism. Not available with fixed loop (A77) arm. See page 536 for additional LT and HD options.

#### 3. Mechanism

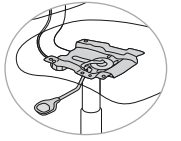
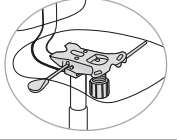
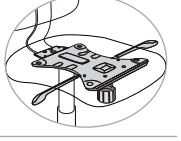
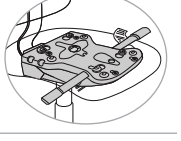
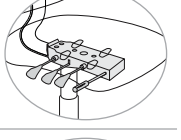
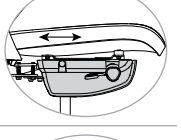
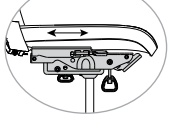
Mechanism	Code	Price	
Basic (Swivel Only)	B	- \$127	
Swivel-Tilt	T	- \$90	
Standard Synchro	F	- \$57	
Enhanced Syncho	Y	+ \$0	
Multi-Function	M	+ \$36	
Enhanced Syncho Seat-Depth Adjustment	Y E3	+ \$79	
Multi-Function Seat-Depth Adjustment	M E3	+ \$115	

## UPHOLSTERED BACK TASK CHAIR

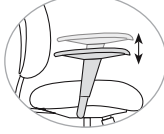
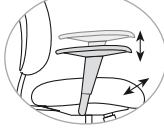

### 4. Arms

Arm Style	Code	Price	
Armless	A0	- \$90	
Fixed Loop	A77	- \$15	
Height-Adjustable	A80	+ \$0	
Height-/Width-Adjustable	A81	+ \$25	

### 5. Base

Base Color and Material	Code	Price	
Black Nylon Base	B0	+ \$0	
Black Nylon Base, 26"	B7	+ \$0	
Brushed Aluminum Base	B2	+ \$113	
Polished Aluminum Base	B5	+ \$167	

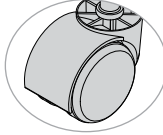
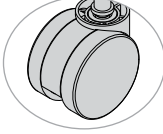
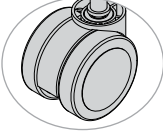
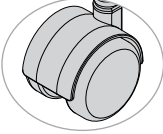
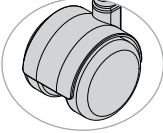
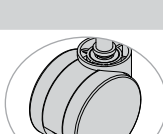
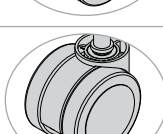
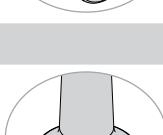
### 5. Base (Cont.)

Casters or Glides	Code	Price	
<b>Casters</b>			
Carpet Casters	C5	+ \$0	
Hard Floor and Carpet Casters	C1	+ \$40	
Heavy Duty Carpet Casters	C11	+ \$30	
Heavy Duty Hard Floor and Carpet Casters	C9	+ \$61	
Self-Locking Carpet Casters	C2	+ \$30	
Self-Locking Hard Floor and Carpet Casters	C7	+ \$61	
<b>Heavy Duty Casters (For HD Models)</b>			
Heavy Duty Carpet Casters	C11	+ \$0	
Heavy Duty Hard Floor and Carpet Casters	C9	+ \$61	
<b>Glides</b>			
Glides for Task Chairs	C3	+ \$30	

*Black nylon base (B0) and polished aluminum base (B5) are not available for Heavy Duty (HD) option.*

*Self-locking casters (C2/C7) lock only when not in use.*

### 6. Material

Protection	Code	Price	
<b>Fire Retardancy</b>			
CAL 133, Fabric, Quantities 1-49	133F	+ \$99	
CAL 133, Fabric, Quantities 50+	133F5	+ \$55	
CAL 133, Leather, Any Quantity	133L	+ \$119	
Ballistic Nylon Back	Code	Price	
Ballistic Nylon Back	BN	+ \$0	
Seat and Back Textile	Code	Price	
Fabric/Vinyl Grade 1	FG1/VG1	+ \$0	
COM	COM	+ \$34	
Fabric/Vinyl Grade 2	FG2/VG2	+ \$34	
Fabric/Vinyl Grade 3	FG3/VG3	+ \$74	
Fabric/Vinyl Grade 4	FG4/VG4	+ \$121	
Fabric/Vinyl Grade 5	FG5/VG5	+ \$174	
Fabric/Vinyl Grade 6	FG6/VG6	+ \$235	
Fabric/Vinyl Grade 7	FG7/VG7	+ \$296	
Leather Grade 1	LG1	+ \$260	
COL	COL	+ \$320	
Leather Grade 2	LG2	+ \$320	
Leather Grade 3	LG3	+ \$400	

Please reference the *Textile Reference Guide* for pricing on fabric over grade 7 and leather over grade 3. Additional CAL 133 information can be found on page 10.

### 7. Packaging

Packaging	Code	Price	
Knocked Down	KD	+ \$0	
Back Attached to Seat, Base Separate	UC	+ \$80	
Fully Assembled in a Carton	AC	+ \$200	

### SPECIFICATIONS

	3323 Midback Task Chair
<b>Dimensions</b>	
Overall Width	26"
Overall Depth	26"
Overall Height	34.5" (T/F) 35.5" (Y/M)
With Aluminum Base	35" (T/F) (B2) 36" (Y/M) (B2)
Seat Width	20.5"
Seat Depth	18"
Seat Height	16.5"-21" (T/F/M) 17.5"-22" (Y)
	17"-21.5" (T/F/M) (B2/B5) 18"-22.5" (Y) (B2/B5)
Back Width	20"
Back Height	19.5"
<b>Materials</b>	
COM	1.85 yd 1.55 yd (BN)
COL	32 sq ft 27 sq ft (BN)
<b>Weight and Capacity</b>	
Weight Armless	39 lb
Weight With Arms	45 lb
Weight Capacity Warranty	300 lb 350 lb (M/Y)(HD)

Swivel-tilt mechanism (T). Standard synchro mechanism (F). Enhanced synchro mechanism (Y). Multi-function mechanism (M). Brushed aluminum base (B2). Polished aluminum base (B5).

# Knack

## TASK STOOL

### *Smart choice. Everyday.*

Knack™ boasts an uncluttered and traditional design that makes it an essential and affordable choice for corporate, healthcare, government and educational settings. The soft, comfortable back follows the natural curve of the spine, providing great support for hours of sitting. The Knack stool comes with three arm options and choice of standard black or polished aluminum base.



EFFECTIVE DECEMBER 1, 2021

### Featured Models

#### **GOOD :: \$736**

Midback stool, basic mechanism, armless, standard stool kit, black nylon base, carpet casters, grade 1 textile

#### **BETTER :: \$826**

Midback stool, basic mechanism, height-adjustable arms, standard stool kit, black nylon base, carpet casters, grade 1 textile

#### **BEST :: \$875**

Midback stool, basic mechanism, height-/width-adjustable arms, extended stool kit, black nylon base, carpet casters, grade 1 textile

## Features

- Durable and ergonomic
- Internal back-height adjustment (on Y and M mechanisms only)
- Ballistic nylon back (optional)
- Black nylon or polished aluminum base
- Waterfall seat
- 300 lb weight capacity

### 1. Back

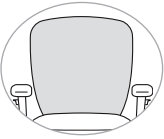
Back Size and Style	Code	Price	
Midback Task Stool With Basic Mechanism (Swivel Only)	3323B	\$826	

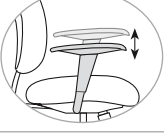
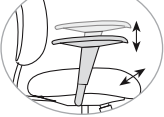

### 2. Arms

Arm Style	Code	Price	
Armless	A0	-\$90	
Fixed Loop	A77	-\$15	
Height-Adjustable	A80	+\$0	
Height-/Width-Adjustable	A81	+\$25	

## UPHOLSTERED BACK TASK STOOL

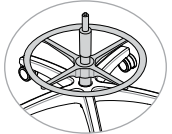
### 3. Base

Base	Code	Price	
Stool Kit	S1	+\$0	
Extended Stool Kit	S2	+\$24	

Base Color and Material	Code	Price	
Black Nylon Base	B0	+\$0	
Polished Aluminum Base	B5	+\$167	

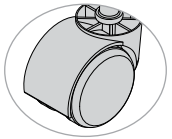
Casters or Glides	Code	Price	
Carpet Casters	C5	+\$0	
Hard Floor and Carpet Casters	C1	+\$40	

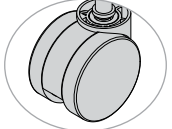
Heavy Duty Carpet Casters	C11	+\$30	
---------------------------	-----	-------	---

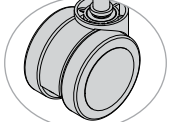
Heavy Duty Hard Floor and Carpet Casters	C9	+\$61	
--	----	-------	---

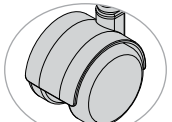
Self-Locking Carpet Casters	C2	+\$30	
-----------------------------	----	-------	---

Self-Locking Hard Floor and Carpet Casters	C7	+\$61	
--	----	-------	---

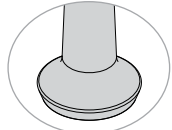
Glides			
Glides for Task Chairs	C3	+\$30	

Self-locking casters (C2/C7) lock only when not in use.

## UPHOLSTERED BACK TASK STOOL

### 4. Material

Protection	Code	Price
<b>Fire Retardancy</b>		
CAL 133, Fabric, Quantities 1-49	133F	+ \$99
CAL 133, Fabric, Quantities 50+	133F5	+ \$55
CAL 133, Leather, Any Quantity	133L	+ \$119
Ballistic Nylon Back	Code	Price
Ballistic Nylon Back	BN	+ \$0
Seat and Back Textile	Code	Price
Fabric/Vinyl Grade 1	FG1/VG1	+ \$0
COM	COM	+ \$34
Fabric/Vinyl Grade 2	FG2/VG2	+ \$34
Fabric/Vinyl Grade 3	FG3/VG3	+ \$74
Fabric/Vinyl Grade 4	FG4/VG4	+ \$121
Fabric/Vinyl Grade 5	FG5/VG5	+ \$174
Fabric/Vinyl Grade 6	FG6/VG6	+ \$235
Fabric/Vinyl Grade 7	FG7/VG7	+ \$296
Leather Grade 1	LG1	+ \$260
COL	COL	+ \$320
Leather Grade 2	LG2	+ \$320
Leather Grade 3	LG3	+ \$400

Please reference the Textile Reference Guide for pricing on fabric over grade 7 and leather over grade 3. Additional CAL 133 information can be found on page 10.

### 5. Packaging

Packaging	Code	Price
Knocked Down	KD	+ \$0
Back Attached to Seat, Base Separate	UC	+ \$80
Fully Assembled in a Carton	AC	+ \$200

### SPECIFICATIONS

	3323 S1 Midback Task Stool	3323 S2 Extended Midback Task Stool
<b>Dimensions</b>		
Overall Width	27"	27"
Overall Depth	26.5"	26.5"
Overall Height With Aluminum Base	44" 44.5" (B5)	44" 44.5" (B5)
Seat Width	21.5"	21.5"
Seat Depth	18"	18"
Seat Height With Aluminum Base	19.5"-27.5" 20"-28" (B2)	23.5"-33.5" 24"-34" (B2)
Back Width	20.5"	20.5"
Back Height	19.5"	19.5"
<b>Materials</b>		
COM	1.85 yd 1.55 yd (BN)	1.85 yd 1.55 yd (BN)
COL	32 sq ft 27 sq ft (BN)	32 sq ft 27 sq ft (BN)
<b>Weight and Capacity</b>		
Weight Armless	53 lb	59 lb
Weight With Arms	67 lb	73 lb
Weight Capacity Warranty	300 lb	300 lb

Ballistic nylon back (BN). Polished aluminum base (B2).

# Lumin

## LIGHT TASK CHAIR AND TASK STOOL

### *Light up the room.*

Lumin™ is an elegant chair designed for exceptional support and comfort in corporate and education applications. The contoured seat dissipates pressure points for greater comfort while the perforated back adds contemporary style and comfortable breathability. The Lumin light task chair and light task stool are available in black or silver frame finish with matching arm pad colors. Refined, sophisticated Lumin will light up the room.



EFFECTIVE DECEMBER 1, 2021

### Featured Models

#### **GOOD :: \$459**

All plastic seat and back, basic mechanism, armless, black frame, carpet casters

#### **BETTER :: \$610**

Plastic back, upholstered seat, basic mechanism, fixed arms, silver frame, carpet casters, grade 1 textile

#### **BEST :: \$633**

Upholstered seat and back, basic mechanism, fixed arms, black frame, carpet casters, grade 1 textile



### Features

- Contemporary design
- Exceptional support and comfort
- Fully upholstered, upholstered seat or plastic
- 14 plastic shell colors
- Two frame finishes with matching arm pads
- Built-in pull handle
- Clean-out space
- 300 lb weight capacity warranty
- Complements Lumin multipurpose chair, counter and bar stool; see page 228



### 1. Back



Back and Seat Style	Code	Price	
Plastic Seat	PS	\$459	
Upholstered Seat Only	US	\$517	
Upholstered Seat and Back	UP	\$575	

### 2. Frame

Frame Type	Code	Price	
Task	1012 FT3	+ \$0	
Task Stool	1012 FT3 S21	+ \$132	
Extended Task Stool	1012 FT3 S22	+ \$156	
Frame Finish	Code	Price	
Black	FC1	+ \$0	
Silver	FC2	+ \$35	

*Lumin task comes with basic mechanism (swivel only).*

### 3. Arms

Arm Style	Code	Price	
Armless	A0	+ \$0	
Fixed	A147	+ \$58	

### 4. Base

Base Color and Material	Code	Price	
Black Nylon Base (For Black Frame FC1)	B17	+ \$0	
Fog Nylon Base (For Silver Frame FC2)	B21	+ \$0	

Casters or Glides	Code	Price	
<b>Casters</b>			

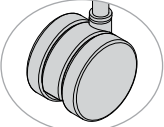
Carpet Casters	C15	+ \$0	
----------------	-----	-------	---

Hard Floor and Carpet Casters	C14	+ \$40	
-------------------------------	-----	--------	---

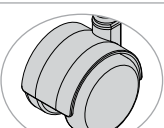
Self-Locking Carpet Casters	C20	+ \$30	
-----------------------------	-----	--------	---

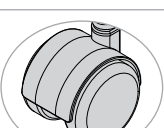
Self-Locking Hard Floor and Carpet Casters	C19	+ \$64	
--	-----	--------	---

<b>Glides</b>			
---------------	--	--	--

Glides for Task Chairs	C3	+ \$30	
------------------------	----	--------	---

Self-locking casters (C19/C20) lock only when not in use.

### LIGHT TASK CHAIR AND TASK STOOL

### 5. Material

Protection	Code	Price	
<b>Fire Retardancy</b>			
CAL 133, Fabric, Quantities 1-49	133F	+ \$64	
CAL 133, Fabric, Quantities 50+	133F5	+ \$20	
CAL 133, Plastic, Any Quantity	133P	+ \$10	

Shell Color	Code	Price	
Apple	SC24	+ \$0	
Arctic	SC21	+ \$0	
Bisque	SC7	+ \$0	
Black	SC1	+ \$0	
Chocolate	SC4	+ \$0	
Lagoon	SC15	+ \$0	
Latte	SC20	+ \$0	
Lemon	SC25	+ \$0	
Navy	SC5	+ \$0	
Pacific	SC22	+ \$0	
Red	SC19	+ \$0	
Slate	SC8	+ \$0	
Sterling	SC18	+ \$0	
Tangerine	SC23	+ \$0	

Textile	Code	Price	
<b>Seat Textile Only (For US)</b>			
Fabric/Vinyl Grade 1	FG1/VG1	+ \$0	
COM	COM	+ \$22	
Fabric/Vinyl Grade 2	FG2/VG2	+ \$22	
Fabric/Vinyl Grade 3	FG3/VG3	+ \$45	
Fabric/Vinyl Grade 4	FG4/VG4	+ \$77	
Fabric/Vinyl Grade 5	FG5/VG5	+ \$116	
Fabric/Vinyl Grade 6	FG6/VG6	+ \$159	
Fabric/Vinyl Grade 7	FG7/VG7	+ \$200	

Textile	Code	Price	
<b>Seat and Back Textile (For UP)</b>			
Fabric Grade 1	FG1/VG1	+ \$0	
COM	COM	+ \$34	
Fabric/Vinyl Grade 2	FG2/VG2	+ \$34	
Fabric/Vinyl Grade 3	FG3/VG3	+ \$74	
Fabric/Vinyl Grade 4	FG4/VG4	+ \$121	
Fabric/Vinyl Grade 5	FG5/VG5	+ \$174	
Fabric/Vinyl Grade 6	FG6/VG6	+ \$235	
Fabric/Vinyl Grade 7	FG7/VG7	+ \$296	

Please reference the *Textile Reference Guide* for pricing on fabric over grade 7. Additional CAL 133 information can be found on page 10.

## LIGHT TASK CHAIR AND TASK STOOL

### 6. Packaging

Packaging	Code	Price
Back Attached to Seat, Base Separate	UC	+ \$0
Fully Assembled in Carton	AC	+ \$120

### SPECIFICATIONS

	1012 FT3 Task Chair	1012 FT3 S21 Task Stool	1012 FT3 S22 Extended Task Stool
<b>Dimensions</b>			
Overall Width	27"	27"	27"
Overall Depth	27"	27"	27"
Overall Height	31.9"–36.9"	37.9"–45.9"	41.9"–51.9"
Seat Width	18.5"	18.5"	18.5"
Seat Depth	18.2"	18.2"	18.2"
Seat Height	16.62"–21.75"	18"–26"	23"–33"
Back Width	17.5"	17.5"	17.5"
Back Height	18.2"	18.2"	18.2"
<b>Materials</b>			
Weight Armless	20.5"	25.1"	26"
Weight With Arms	22.2"	26.8"	27.7"
COM	0.85 yd (US) 1 yd (UP)	0.85 yd (US) 1 yd (UP)	0.85 yd (US) 1 yd (UP)
COL	10 sq ft (US) 15 sq ft (UP)	10 sq ft (US) 15 sq ft (UP)	10 sq ft (US) 15 sq ft (UP)
<b>Weight and Capacity</b>			
Weight Armless	20.5"	25.1"	26"
Weight With Arms	22.2"	26.8"	27.7"
Weight Capacity	300 lb	300 lb	300 lb
Warranty			

*Upholstered seat only (US). Upholstered seat and back (UP).*



Best

# Mavic

## COLLABORATIVE CHAIR

### *Cross over collaboration.*

Mavic™ is here to prove that a jack-of-all-trades can be a master of all. Looks, features, function, comfort and more—there's so much Mavic offers in a single, light-scale seat that it crosses over into new territory. So when it's time to enable collaboration (wherever and whenever you need it), Mavic sits ready to provide a radical new way to work.



**EFFECTIVE DECEMBER 1, 2021**

### Featured Models

#### **GOOD :: \$753**

Floating mesh back with integrated arms, swivel-tilt mechanism, black frame and black nylon base, caster ring accent color, carpet casters, grade 1 textile

#### **BETTER :: \$835**

Floating mesh back with integrated arms, weight-activated mechanism with recline tilt limiter, white frame and white nylon base, caster ring accent color, carpet casters, grade 1 textile

### Features

- Designed by Martin Ballendat
- Slim, single-piece frame design
- Swivel-tilt or weight-activated mechanism
- Eight-hour endurance cushion with 15,000+ textile options
- Built-in lumbar support from tension mesh
- Tapered seat pan with almost-invisible controls
- Advanced adjustments include seat slider and tilt limiter/override
- Performance casters color coordinate with the frame and base
- Three frame and base, 10 mesh and 12 accent color options
- 300 lb weight capacity warranty

#### 1. Back

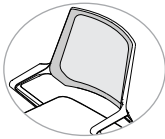
Back Size and Style	Code	Price	
Midback Mesh	1113 MB	\$753	

#### 2. Mechanism

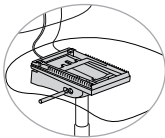
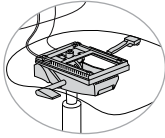
Mechanism	Code	Price	
Swivel-Tilt	T	+\$0	
Weight-Activated With Override, Tilt Limiter and Seat Slider	WA	+\$47	

#### 3. Frame

Frame Color	Code	Price	
Black	FC1	+\$0	
Fog	FC13	+\$35	
White	FC12	+\$35	

#### 3. Frame

Frame Color	Code	Price	
Apple	LA12	+\$0	
Desert	LA3	+\$0	
Electric Blue	LA5	+\$0	
Fire	LA6	+\$0	
Fog	LA4	+\$0	
Graphite	LA14	+\$0	
Navy	LA15	+\$0	
Nickel	LA2	+\$0	
Ocean	LA10	+\$0	
Onyx	LA1	+\$0	
Tangerine	LA9	+\$0	
White	LA13	+\$0	

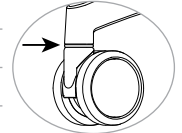

Accent color will apply to caster rings.

#### 4. Base

Base Style	Code	Price	
5-Star Nylon	BT1	+\$0	

Base Color	Code	Price	
Black Nylon Base	BC1	+\$0	
Fog Nylon Base	BC4	+\$0	
White Nylon Base	BC3	+\$0	

Casters or Glides	Code	Price	
<b>Casters</b>			

Carpet Casters	CS5	+\$0	
Hard Floor and Carpet Casters	CS6	+\$40	

<b>Glides</b>			
---------------	--	--	--

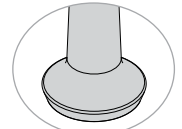
Glides for Task Chairs	CS3	+\$30	
------------------------	-----	-------	---

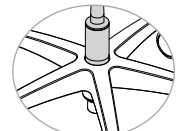
Cylinder Height	Code	Price	
Standard Cylinder	CH1	+\$0	

Frame, base and caster color will correspond when the nylon base (BT1) is selected.

## 5. Material

Protection	Code	Price	
<b>Fire Retardancy</b>			
CAL 133, Fabric, Quantities 1-49	133F	+ \$99	
CAL 133, Fabric, Quantities 50+	133F5	+ \$55	
CAL 133, Leather, Any Quantity	133L	+ \$119	
Mesh Color	Code	Price	
Apple	MC31	+ \$0	
Desert	MC9	+ \$0	
Electric Blue	MC13	+ \$0	
Fire	MC10	+ \$0	
Fog	MC7	+ \$0	
Navy	MC8	+ \$0	
Nickel	MC6	+ \$0	
Ocean	MC29	+ \$0	
Onyx	MC5	+ \$0	
Tangerine	MC28	+ \$0	
Seat Textile	Code	Price	
Fabric/Vinyl Grade 1	FG1/VG1	+ \$0	
COM	COM	+ \$26	
Fabric/Vinyl Grade 2	FG2/VG2	+ \$26	
Fabric/Vinyl Grade 3	FG3/VG3	+ \$60	
Fabric/Vinyl Grade 4	FG4/VG4	+ \$116	
Fabric/Vinyl Grade 5	FG5/VG5	+ \$172	
Fabric/Vinyl Grade 6	FG6/VG6	+ \$213	
Fabric/Vinyl Grade 7	FG7/VG7	+ \$254	
Leather Grade 1	LG1	+ \$300	
COL	COL	+ \$380	
Leather Grade 2	LG2	+ \$380	
Leather Grade 3	LG3	+ \$480	

Please reference the *Textile Reference Guide* for pricing on fabric over grade 7 and leather over grade 3. Additional CAL 133 information can be found on page 10.

## 6. Packaging

Packaging	Code	Price	
Back Attached to Seat, Base Separate	UC	+ \$0	
Fully Assembled in a Carton	AC	+ \$120	

## COLLABORATIVE CHAIR

### SPECIFICATIONS

	1113 MB
<b>Dimensions</b>	
Overall Width With Arms	23.5"
Overall Depth	23.5"
Overall Height	35.4"
Seat Width	19"
Seat Depth	17.5"
Seat Height	17.5"-21.5"
Back Width	20"
Back Height	20"
<b>Materials</b>	
COM	0.8 yd
COL	14 sq ft
<b>Weight and Capacity</b>	
Weight With Arms	24.5 lb
Weight Capacity Capacity	300 lb



Good

# Movi

## LIGHT TASK CHAIR AND STOOL

*Movement-inspired.  
Collaboration-friendly.*

For all those quick touch bases that end up being anything but, there's the Movi™ light task chair —an agile task chair that can adapt quickly to a constantly changing environment. Whether you need to quickly set up (or clean up), we've got a chair with nesting abilities that can keep up.



**EFFECTIVE DECEMBER 1, 2021**

### Featured Models

**GOOD :: \$692**

Mesh back, upholstered seat, basic mechanism, armless, black frame, carpet casters, grade 1 textile

**BETTER :: \$722**

Mesh back, upholstered seat, basic mechanism, fixed arms, black frame, carpet casters, grade 1 textile



**BEST :: \$757**

Mesh back, upholstered seat, basic mechanism, fixed arms, white frame, carpet casters, grade 1 textile

## Features

- Flexes at the hip 14 degrees for enhanced comfort
- Movement-friendly back and arm support
- Clean-out space for easy maintenance
- Bleach-cleanable mesh back
- 12 mesh colors
- Three base frame and caster colors
- Three back frame and arm colors
- Available as an armless option
- Carpet, hard floor and carpet casters available
- 300 lb weight capacity warranty
- Complements Movi nester; see page 236

### 1. Frame



Frame Type	Code	Price	
Task	1062 FT3 MB	\$722	
Task Stool	1062 FT3 S21 MB	\$828	
Extended Task Stool	1062 FT3 S22 MB	\$852	

Back Frame Finish	Code	Price	
Black	SC1	+ \$0	
Fog	SC27	+ \$35	
White	SC26	+ \$35	

Movi task models come with basic mechanism (swivel only).

## LIGHT TASK CHAIR AND STOOL

### 2. Arms

Arm Style	Code	Price	
Armless	AR0	-\$30	
Fixed Loop Arms	AR1	+ \$0	

Arms (AR1) will match frame color.

### 3. Base

Base Color and Material	Code	Price	
Black Nylon Base With Black Casters	B17	+ \$0	
Fog Nylon Base With Fog Casters	B21	+ \$0	
White Nylon Base With Fog/White Casters	B20	+ \$0	
Casters or Glides	Code	Price	
<b>Casters</b>			
Carpet Casters	CS5	+ \$0	
Hard Floor and Carpet Casters	CS6	+ \$40	
<b>Glides</b>			
Bell Glides	CS20	+ \$30	



## 4. Material

Protection	Code	Price	
<b>Fire Retardancy</b>			
CAL 133, Fabric, Quantities 1-49	133F	+ \$99	
CAL 133, Fabric, Quantities 50+	133F5	+ \$55	
Mesh Color	Code	Price	
Apple	MC31	+ \$0	
Aqua	MC30	+ \$0	
Desert	MC22	+ \$0	
Electric Blue	MC24	+ \$0	
Fire	MC25	+ \$0	
Fog	MC23	+ \$0	
Grape	MC26	+ \$0	
Lemon	MC27	+ \$0	
Nickel	MC21	+ \$0	
Ocean	MC29	+ \$0	
Onyx	MC20	+ \$0	
Tangerine	MC28	+ \$0	
Seat Textile	Code	Price	
Fabric/Vinyl Grade 1	FG1/VG1	+ \$0	
COM	COM	+ \$22	
Fabric/Vinyl Grade 2	FG2/VG2	+ \$22	
Fabric/Vinyl Grade 3	FG3/VG3	+ \$45	
Fabric/Vinyl Grade 4	FG4/VG4	+ \$77	
Fabric/Vinyl Grade 5	FG5/VG5	+ \$116	
Fabric/Vinyl Grade 6	FG6/VG6	+ \$159	
Fabric/Vinyl Grade 7	FG7/VG7	+ \$200	

Please reference the *Textile Reference Guide* for pricing on fabric over grade 7. Additional CAL 133 information can be found on page 10.

## 5. Packaging

Packaging	Code	Price	
Back Attached to Seat, Base Separate	UC	+ \$0	
Fully Assembled in Carton	AC	+ \$120	

## LIGHT TASK CHAIR AND STOOL

### SPECIFICATIONS

	1062 FT3 Task Chair	1062 S21 Task Stool	1062 S22 Extended Task Stool
<b>Dimensions</b>			
Overall Width	26"	26"	26"
Overall Depth	26"	26"	26"
Overall Height	34.5"	37.75"	41"
Seat Width	19"	19"	19"
Seat Depth	17"	17"	17"
Seat Height	17.5"-22.5"	21.5"-28.5"	24.5"-34"
Back Width	18"	18"	18"
Back Height	18"	18"	18"
<b>Materials</b>			
COM	0.75 yd	0.75 yd	0.75 yd
COL	10 sq ft	10 sq ft	10 sq ft
<b>Weight and Capacity</b>			
Weight Armless	22 lb	27 lb	28 lb
Weight With Arms	23 lb	28 lb	29 lb
Weight Capacity Warranty	300 lb	300 lb	300 lb



# Non-Stop

HEAVY DUTY TASK CHAIR

## *Around-the-clock comfort.*

Designed for durability and backed by solid steel, Non-Stop™ differs from the typical chair construction in that all mounting points—seat to mech, arms to seat and J-bar to back—are reinforced with heavy-gauge steel mounting brackets. These solid steel fasteners are second to none for reliability and ergonomic comfort in high-intensity environments where chairs perform all day, every day and support a wide range of users. This Heavy Duty chair is rated to accommodate users up to 500 pounds and easily handles the demands of 24-hour environments.



*Best*

**EFFECTIVE DECEMBER 1, 2021**

## Featured Models

### **GOOD :: \$2,116**

Task size 3, dual torsion mechanism, armless, black aluminum base, carpet casters, grade 1 textile

### **BETTER :: \$2,276**

Task size 3, dual torsion mechanism, large loop arms, black aluminum base, carpet casters, grade 1 textile

### **BEST :: \$2,443**

Task size 3, dual torsion mechanism, large loop arms, polished aluminum base, carpet casters, grade 1 textile

## Features

- Reinforced heavy gauge steel mounting brackets
- Resilient multilayer cushioning
- Waterfall seat promotes proper leg circulation
- Heavy-duty 24/7 option warranted to 500 lb weight capacity



### 1. Back

Back Size and Style	Code	Price	
Task Size 3: Extra Large	673	\$2,276	

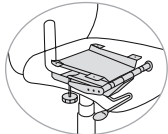
### 2. Mechanism

Mechanism Style	Code	Price	
Dual Torsion	DT	+ \$0	

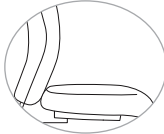
### 3. Arms

Arm Style	Code	Price	
Armless	A0	- \$160	
Large Loop	A72	+ \$0	

### 4. Base

Base Color and Material	Code	Price	
Black Aluminum Base	B0	+ \$0	
Polished Aluminum Base	B5	+ \$167	

## HEAVY DUTY TASK CHAIR

### 4. Base (Cont.)

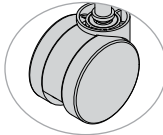
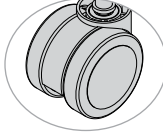
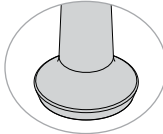
Casters or Glides	Code	Price	
<b>Casters</b>			
Heavy Duty Carpet Casters	C11	+ \$0	
Heavy Duty Hard Floor and Carpet Casters	C9	+ \$61	
<b>Glides</b>			
Glides for Task Chairs	C3	+ \$30	

### 5. Material

Protection	Code	Price	
<b>Fire Retardancy</b>			
CAL 133, Fabric, Quantities 1-49	133F	+ \$99	
CAL 133, Fabric, Quantities 50+	133F5	+ \$55	
<b>Ballistic Nylon</b>			
Ballistic Nylon Back	BN	+ \$0	
<b>Seat and Back Textile</b>			
Fabric/Vinyl Grade 1	FG1/VG1	+ \$0	
COM	COM	+ \$40	
Fabric/Vinyl Grade 2	FG2/VG2	+ \$40	
Fabric/Vinyl Grade 3	FG3/VG3	+ \$84	
Fabric/Vinyl Grade 4	FG4/VG4	+ \$156	
Fabric/Vinyl Grade 5	FG5/VG5	+ \$228	
Fabric/Vinyl Grade 6	FG6/VG6	+ \$304	
Fabric/Vinyl Grade 7	FG7/VG7	+ \$378	

Please reference the Textile Reference Guide for pricing on fabric over grade 7. Additional CAL 133 information can be found on page 10.

### 6. Packaging

Packaging	Code	Price	
Back Attached to Seat, Base Separate	UC	+ \$0	

**HEAVY DUTY TASK CHAIR**

**SPECIFICATIONS**

673 Task Chair Size 3	
<b>Dimensions</b>	
Overall Width	30"
Overall Depth	28.5"
Overall Height	39.5"
Seat Width	23"
Seat Depth	19.5"
Seat Height	20.375"-23.25"
Back Width	22"
Back Height	21.5" (DT)
<b>Materials</b>	
COM	2.5 yd 2 yd (BN)
COL	44 sq ft 35 sq ft (BN)
<b>Weight and Capacity</b>	
Weight Armless	67 lb (DT)
Weight With Arms	79 lb (DT)
Weight Capacity Warranty	500 lb

*Ballistic nylon back (BN).*



*Better*

# Non-Stop

## HEAVY DUTY TASK STOOL

### *Around-the-clock comfort.*

Designed for durability and backed by solid steel; Non-Stop™ differs from the typical stool construction in that all mounting points—seat to mech, arms to seat and J-bar to back—are reinforced with heavy-gauge steel mounting brackets. These solid steel fasteners are second to none for reliability and ergonomic comfort in high-intensity environments where chairs perform all day, every day and support a wide range of users. This Heavy Duty stool is rated to accommodate users up to 350 pounds and easily handles the demands of 24-hour environments.



EFFECTIVE DECEMBER 1, 2021

### Featured Models

#### **GOOD :: \$1,695**

Size 1 task stool, basic mechanism, armless, black nylon base, carpet casters, grade 1 textile

#### **BETTER :: \$1,855**

Size 1 task stool, basic mechanism, height-adjustable arms, black nylon base, carpet casters, grade 1 textile

#### **BEST :: \$2,076**

Size 1 task stool, basic mechanism, height-/width-adjustable arms, extended stool kit, polished aluminum base, carpet casters, grade 1 textile

## Features



- Reinforced heavy gauge steel mounting brackets
- Resilient multilayer cushioning
- Waterfall seat promotes proper leg circulation
- Heavy-duty 24/7 option warranted to 350 lb weight capacity

### 1. Back

Back Size and Style	Code	Price	
Task Size 1: Heavy Duty Stool	671 B2	\$1,855	

Only available with basic mechanism (swivel only).

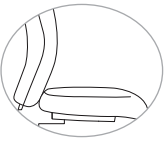

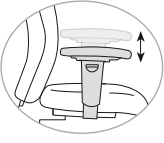
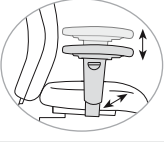
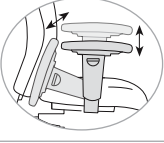
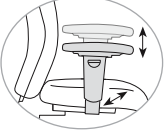
### 2. Arms

Arm Style	Code	Price	
Armless	A0	- \$160	
Small Loop	A67	+ \$0	
Height-Adjustable	A68	+ \$0	
Height-/Width-Adjustable	A69	+ \$30	
Height-Adjustable Break-Away	A71	+ \$30	
Height-/Width-Adjustable Articulating	A70	+ \$62	

## HEAVY DUTY TASK STOOL

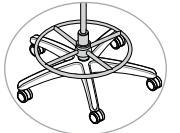
### 3. Base

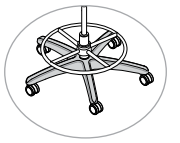
Base	Code	Price	
Standard Stool Kit	S1HD	+ \$0	
Extended Stool Kit	S2HD	+ \$24	

Base Color and Material	Code	Price	
Black Nylon Base	B0	+ \$0	
Black Aluminum	B4	+ \$167	
Polished Aluminum Base	B5	+ \$167	

Casters or Glides	Code	Price	
<b>Casters</b>			

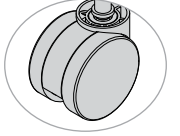
Heavy Duty Carpet Casters	C11	+ \$0	
------------------------------	-----	-------	--

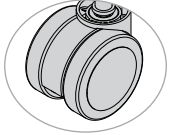
Heavy Duty Hard Floor and Carpet Casters	C9	+ \$61	
---	----	--------	---

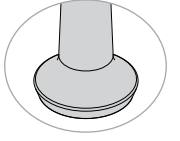
<b>Glides</b>			
Glides for Task Chairs	C3	+ \$30	

## 4. Material (Cont.)

Protection	Code	Price	
<b>Fire Retardancy</b>			
CAL 133, Fabric, Quantities 1-49	133F	+ \$99	
CAL 133, Fabric, Quantities 50+	133F5	+ \$55	
Ballistic Nylon	Code	Price	
Ballistic Nylon Back	BN	+ \$0	
Seat and Back Textile	Code	Price	
Fabric/Vinyl Grade 1	FG1/VG1	+ \$0	
COM	COM	+ \$40	
Fabric/Vinyl Grade 2	FG2/VG2	+ \$40	
Fabric/Vinyl Grade 3	FG3/VG3	+ \$84	
Fabric/Vinyl Grade 4	FG4/VG4	+ \$156	
Fabric/Vinyl Grade 5	FG5/VG5	+ \$228	
Fabric/Vinyl Grade 6	FG6/VG6	+ \$304	
Fabric/Vinyl Grade 7	FG7/VG7	+ \$378	

Please reference the Textile Reference Guide for pricing on fabric over grade 7. Additional CAL 133 information can be found on page 10.

## 5. Packaging

Packaging	Code	Price	
Knocked Down	KD	+ \$0	
Back Attached to Seat, Base Separate	UC	+ \$80	

## HEAVY DUTY TASK STOOL

### SPECIFICATIONS

	671B2 S1HD Task Stool	671B2 S2HD Extended Task Stool
<b>Dimensions</b>		
Overall Width	27.5"	27.5"
Overall Depth	26.5"	26.5"
Overall Height	40"	42.5"
Seat Width	19.5"	19.5"
Seat Depth	19.5"	19.5"
Seat Height	23"-31"	25.5"-35.5"
Back Width	20.5"	20.5"
Back Height	16"	16"
<b>Materials</b>		
COM	1.75 yd 1.3 yd (BN)	1.75 yd 1.3 yd (BN)
COL	30 sq ft 22 sq ft (BN)	30 sq ft 22 sq ft (BN)
<b>Weight and Capacity</b>		
Weight Armless	55 lb	55 lb
Weight With Arms	68 lb	68 lb
Weight Capacity Warranty	350 lb	350 lb

Ballistic nylon back (BN).

# Novo

## MESH BACK TASK CHAIR

*Hyper-customizable.  
Super-ergonomic.*

Since its launch in 2016, our Novo™ task chair has been recognized for its designer-friendly features and superior ergonomics. With comfort-first design that's also customizable down to the last detail (we offer 13 choices for lumbar accent colors alone!), personalizing is easy—whether you need something professional for the boardroom or vibrant for a modern, collaborative space.



reddot design award  
winner 2017



EFFECTIVE DECEMBER 1, 2021

### Featured Models

#### GOOD :: \$630

Midback mesh with adjustable lumbar, black frame, swivel-tilt mechanism, height-adjustable arms, black nylon base, grade 1 textile

#### BETTER :: \$676

Highback mesh with adjustable lumbar, black frame, standard synchro mechanism, height-adjustable arms, black nylon base, grade 1 textile

#### BEST :: \$820

Highback mesh with adjustable lumbar, fog frame, standard synchro mechanism with seat-depth adjustment, multi-adjustable arms, fog nylon base, grade 1 textile



## MESH BACK TASK CHAIR

### Features

- Midback and highback task chairs
- Adjustable lumbar support comes standard on all models
- Three frame colors with matching base
- Three lumbar colors with 13 lumbar accent colors
- 12 mesh colors
- Basic, standard synchro and swivel-tilt mechanisms
- Three arm types: fixed, height-adjustable or multi-adjustable (height/width)
- Textured, easy-grip arms
- Adjustable seat depth (optional)
- Polished aluminum base (optional)
- Waterfall seat
- Standard 300 lb weight capacity warranty;  
Heavy Duty Series 400 lb weight capacity warranty

### 1. Back

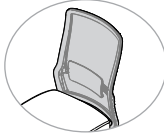
Back Size and Style	Code	Price	
Midback Mesh With Adjustable Lumbar Support	1033 BK1	\$648	
Highback Mesh With Adjustable Lumbar Support	1033 BK2	\$676	

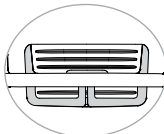

Adjustable Lumbar Color	Code	Price	
Black	AL1	+ \$0	
White	AL2	+ \$0	
Fog	AL3	+ \$0	

### 1. Back (Cont.)

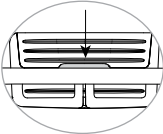

Lumbar Accent Color	Code	Price	
Apple	LA12	+ \$0	
Aqua	LA11	+ \$0	
Desert	LA3	+ \$0	
Electric Blue	LA5	+ \$0	
Fire	LA6	+ \$0	
Fog	LA4	+ \$0	
Grape	LA7	+ \$0	
Lemon	LA8	+ \$0	
Nickel	LA2	+ \$0	
Ocean	LA10	+ \$0	
Onyx	LA1	+ \$0	
Tangerine	LA9	+ \$0	
White	LA13	+ \$0	

### 2. Heavy Duty

Heavy Duty Series	Code	Price	
Large and Tall (Black Highback Frame With Enhanced Synchro Y Mechanism and Sport Height-Adjustable Arms)	LT	+ \$295	

See page 536 for additional LT and HD options.

### 3. Mechanism

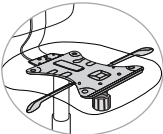
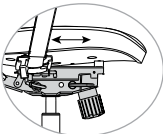
Mechanism Style	Code	Price	
Basic (Swivel Only)	B	- \$33	
Swivel-Tilt	T	- \$18	
Standard Synchro	F	+ \$0	
Standard Synchro With Seat-Depth Adjustment	F E3	+ \$79	

Seat-depth adjustment (F E3) not available on lower cylinder (CH4).

## MESH BACK TASK CHAIR

### 4. Frame

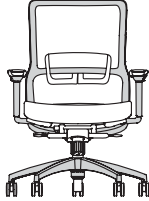
Frame Color	Code	Price	
Black	FC1	+ \$0	
White	FC12	+ \$35	
Fog	FC13	+ \$35	

### 5. Arms

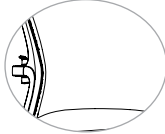
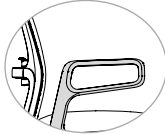
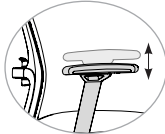
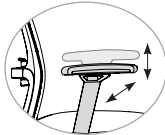
Arm Style	Code	Price	
Armless	AR0	- \$48	
Fixed Task	AR2	- \$10	
Height-Adjustable	AR4	+ \$0	
Multi-Adjustable (Height/Width)	AR6	+ \$30	

### 6. Base

Base Color and Material	Code	Price	
Black Nylon Base (For Black Frame FC1)	B17	+ \$0	
White Nylon Base (For White Frame FC12)	B20	+ \$0	
Fog Nylon Base (For Fog Frame FC13)	B21	+ \$0	

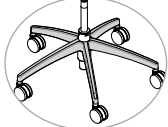
Polished Aluminum Base	B18	+ \$113	
------------------------	-----	---------	---

Casters or Glides	Code	Price	
<b>Casters</b>			

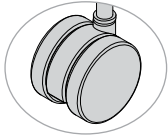
Carpet Casters	CS5	+ \$0	
----------------	-----	-------	---

Hard Floor and Carpet Casters	CS6	+\$40	
-------------------------------	-----	-------	--

<b>Glides</b>			
---------------	--	--	--

Glides for Task Chairs	CS3	+\$30	
------------------------	-----	-------	---

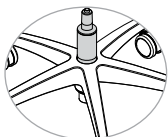
Cylinder Height	Code	Price	
Standard Cylinder	CH1	+ \$0	
Higher Cylinder	CH3	+ \$0	
Lower Cylinder	CH4	+ \$0	

Nylon bases must match frame color. The polished aluminum base (B18) can be ordered with any frame color.

Higher cylinder (CH3) and lower cylinder (CH4) options are only available with the black nylon base (B17). Style of nylon base will change with higher or lower cylinder.

## 7. Material

Protection	Code	Price
<b>Fire Retardancy</b>		
CAL 133, Fabric, Quantities 1-49	133F	+ \$99
CAL 133, Fabric, Quantities 50+	133F5	+ \$55
CAL 133, Leather, Any Quantity	133L	+ \$119

Mesh Color	Code	Price
Apple	MC31	+ \$0
Aqua	MC30	+ \$0
Desert	MC22	+ \$0
Electric Blue	MC24	+ \$0
Fire	MC25	+ \$0
Fog	MC23	+ \$0
Grape	MC26	+ \$0
Lemon	MC27	+ \$0
Nickel	MC21	+ \$0
Ocean	MC29	+ \$0
Onyx	MC20	+ \$0
Tangerine	MC28	+ \$0

Seat Textile	Code	Price
Fabric/Vinyl Grade 1	FG1/VG1	+ \$0
COM	COM	+ \$26
Fabric/Vinyl Grade 2	FG2/VG2	+ \$26
Fabric/Vinyl Grade 3	FG3/VG3	+ \$60
Fabric/Vinyl Grade 4	FG4/VG4	+ \$116
Fabric/Vinyl Grade 5	FG5/VG5	+ \$172
Fabric/Vinyl Grade 6	FG6/VG6	+ \$213
Fabric/Vinyl Grade 7	FG7/VG7	+ \$254
Leather Grade 1	LG1	+ \$300
COL	COL	+ \$380
Leather Grade 2	LG2	+ \$380
Leather Grade 3	LG3	+ \$480

Please reference the *Textile Reference Guide* for pricing on fabric over grade 7 and leather over grade 3. Additional CAL 133 information can be found on page 10.

## MESH BACK TASK CHAIR

## 8. Packaging

Packaging	Code	Price
Knocked Down	KD	+ \$0
Back Attached to Seat, Base Separate	UC	+ \$80
Fully Assembled in a Carton	AC	+ \$200



Good

## SPECIFICATIONS

	1033.BK1 Midback Task Chair	1033.BK2 Highback Task Chair
<b>Dimensions</b>		
Overall Width Armless	26"	26"
Overall Width With Arms	26"	26"
Overall Depth	26"	26"
Overall Height	36"	39"
Seat Width	20"	20"
Seat Depth	16.5"-18.5"	16.5"-18.5"
Seat Height	16"-19.75" (B)	16"-19.75" (B)
	16.25"-20" (T)	16.25"-20" (T)
	16.75"-20.25" (F)	16.75"-20.25" (F)
	17"-20.625" (F/E3)	17"-20.625" (F/E3)
Seat Height With Higher Cylinder	16.25"-21.25" (B)	16.25"-21.25" (B)
	16.5"-21.5" (T)	16.5"-21.5" (T)
	17"-22" (F)	17"-22" (F)
	17.25"-22.25" (F/E3)	17.25"-22.25" (F/E3)
Seat Height With Lower Cylinder	14.5"-18.25" (B)	14.5"-18.25" (B)
	14.75"-17.5" (T)	14.75"-17.5" (T)
	15.25"-18" (F)	15.25"-18" (F)
	15.5"-18.25" (F/E3)	15.5"-18.25" (F/E3)
Back Width	19"	19"
Back Height	20"	23"
<b>Materials</b>		
COM	1 yd	1 yd
COL	17 sq ft	17 sq ft
<b>Weight and Capacity</b>		
Weight Armless	31 lb	32 lb
Weight With Arms	37 lb	38 lb
Weight Capacity Warranty	300 lb	300 lb

Basic mechanism (B). Swivel-tilt mechanism (T). Standard synchro mechanism (F).  
Seat-depth adjustment (E3). Enhanced synchro mechanism (Y).

## MESH BACK TASK CHAIR

## SPECIFICATIONS

	1033.BK2 LT Large and Tall Task Chair
<b>Dimensions</b>	
Overall Width Armless	26"
Overall Width With Arms	29"
Overall Depth	27.75"
Overall Height	39"
Seat Width	22"
Seat Depth	17.5"-19.5"
Seat Height	17.5"-21.5" (Y)
Seat Height With Higher Cylinder	18"-23" (Y)
Back Width	19"
Back Height	21.5"
<b>Materials</b>	
COM	1.15 yd
COL	18 sq ft
<b>Weight and Capacity</b>	
Weight Armless	46 lb
Weight With Arms	52 lb
Weight Capacity Warranty	400 lb

Enhanced synchro mechanism (Y).

# Novo

## MESH BACK TASK STOOL

*Hyper-customizable.  
Super-ergonomic.*

Since its launch in 2016, our Novo™ collection has been recognized for its designer-friendly features and superior ergonomics. With comfort-first design that's also customizable down to the last detail (we offer 13 choices for lumbar accent colors alone!), personalizing is easy—whether you need something professional for the boardroom or vibrant for a modern, collaborative space.



reddot design award  
winner 2017



best of  
**NeoCon**  
2016  
Gold Award  
presented by  
**contract**



BEST OF YEAR  
HONOREE 2016  
INTERIOR  
DESIGN



EFFECTIVE DECEMBER 1, 2021

### Featured Models

#### GOOD :: \$677

Midback mesh with adjustable lumbar, basic mechanism, black frame, armless, black nylon base, carpet casters, grade 1 textile

#### BETTER :: \$725

Midback mesh with adjustable lumbar, basic mechanism, black frame, height-adjustable arms, black nylon base, carpet casters, grade 1 textile

#### BEST :: \$790

Midback mesh with adjustable lumbar, basic mechanism, white frame, multi-adjustable arms, white nylon base, carpet casters, grade 1 textile

## MESH BACK TASK STOOL

### Features

- Midback task stool
- Adjustable lumbar support comes standard on all models
- Three frame colors with matching base
- Three lumbar colors with 13 lumbar accent colors
- 12 mesh colors
- Basic, standard synchro and swivel-tilt mechanisms
- Three arm types: fixed, height-adjustable or multi-adjustable (height/width)
- Textured, easy-grip arms
- Adjustable seat depth (optional)
- Polished aluminum base (optional)
- Waterfall seat
- Standard 300 lb weight capacity

#### 1. Back

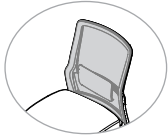
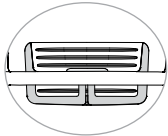
Back Size and Style	Code	Price	
Midback Mesh Task Stool With Adjustable Lumbar Support	1033 BK1	\$725	
Adjustable Lumbar Color	Code	Price	
Black	AL1	+ \$0	
White	AL2	+ \$0	
Fog	AL3	+ \$0	

#### 1. Back (Cont.)

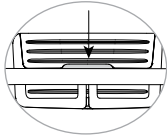
Lumbar Accent Color	Code	Price	
Apple	LA12	+ \$0	
Aqua	LA11	+ \$0	
Desert	LA3	+ \$0	
Electric Blue	LA5	+ \$0	
Fire	LA6	+ \$0	
Fog	LA4	+ \$0	
Grape	LA7	+ \$0	
Lemon	LA8	+ \$0	
Nickel	LA2	+ \$0	
Ocean	LA10	+ \$0	
Onyx	LA1	+ \$0	
Tangerine	LA9	+ \$0	
White	LA13	+ \$0	

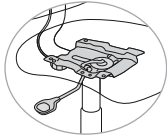

#### 2. Mechanism

Mechanism Style	Code	Price	
Basic (Swivel Only)	B	+ \$0	

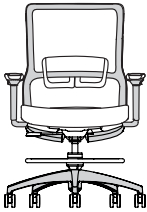

#### 3. Frame

Frame Color	Code	Price	
Black	FC1	+ \$0	
White	FC12	+ \$35	
Fog	FC13	+ \$35	

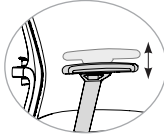
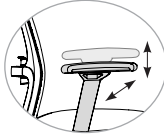
## 4. Arms

Arm Style	Code	Price	
Armless	AR0	- \$48	
Fixed Task	AR2	- \$10	
Height-Adjustable	AR4	+ \$0	
Multi-Adjustable (Height/Width)	AR6	+ \$30	

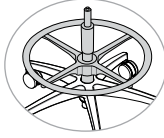
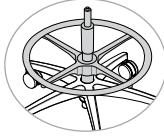
## 5. Base

Base	Code	Price	
Stool Kit	S1	+ \$0	
Extended Stool Kit	S2	+ \$24	
Base Color and Material	Code	Price	
Black Nylon Base (For Black Frame FC1)	B17	+ \$0	
White Nylon Base (For White Frame FC12)	B20	+ \$0	
Fog Nylon Base (For Fog Frame FC13)	B21	+ \$0	
Polished Aluminum Base	B18	+ \$113	

## MESH BACK TASK STOOL

## 5. Base (Cont.)

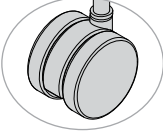
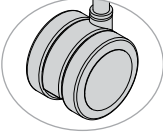
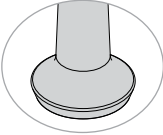
Casters or Glides	Code	Price	
<b>Casters</b>			
Carpet Casters	CS5	+ \$0	
Hard Floor and Carpet Casters	CS6	+ \$40	
<b>Glides</b>			
Glides for Task Chairs	CS3	+ \$30	

*Nylon bases must match frame color. The polished aluminum base (B18) can be ordered with any frame color.*

## 6. Material

Protection	Code	Price	
<b>Fire Retardancy</b>			
CAL 133, Fabric, Quantities 1-49	133F	+ \$99	
CAL 133, Fabric, Quantities 50+	133F5	+ \$55	
CAL 133, Leather, Any Quantity	133L	+ \$119	
Mesh Color	Code	Price	
Apple	MC31	+ \$0	
Aqua	MC30	+ \$0	
Desert	MC22	+ \$0	
Electric Blue	MC24	+ \$0	
Fire	MC25	+ \$0	
Fog	MC23	+ \$0	
Grape	MC26	+ \$0	
Lemon	MC27	+ \$0	
Nickel	MC21	+ \$0	
Ocean	MC29	+ \$0	
Onyx	MC20	+ \$0	
Tangerine	MC28	+ \$0	

MESH BACK TASK STOOL

6. Material (Cont.)

Seat Textile	Code	Price
Fabric/Vinyl Grade 1	FG1/VG1	+ \$0
COM	COM	+ \$26
Fabric/Vinyl Grade 2	FG2/VG2	+ \$26
Fabric/Vinyl Grade 3	FG3/VG3	+ \$60
Fabric/Vinyl Grade 4	FG4/VG4	+ \$116
Fabric/Vinyl Grade 5	FG5/VG5	+ \$172
Fabric/Vinyl Grade 6	FG6/VG6	+ \$213
Fabric/Vinyl Grade 7	FG7/VG7	+ \$254
Leather Grade 1	LG1	+ \$300
COL	COL	+ \$380
Leather Grade 2	LG2	+ \$380
Leather Grade 3	LG3	+ \$480

Please reference the *Textile Reference Guide* for pricing on fabric over grade 7 and leather over grade 3. Additional CAL 133 information can be found on page 10.

7. Packaging

Packaging	Code	Price
Knocked Down	KD	+ \$0
Back Attached to Seat, Base Separate	UC	+ \$80
Fully Assembled in a Carton	AC	+ \$200

SPECIFICATIONS

	1033.BK1 S1 Midback Task Stool	1033.BK1 S2 Extended Task Stool
<b>Dimensions</b>		
Overall Width	26"	27"
Overall Depth	26"	27"
Overall Height	39"	42"
Seat Width	20"	20"
Seat Depth	16.5"	16.5"
Seat Height	21.375"-29"	24.25"-34.25"
Back Width	19"	19"
Back Height	20"	20"
<b>Materials</b>		
COM	1 yd	1 yd
COL	17 sq ft	17 sq ft
<b>Weight and Capacity</b>		
Weight Armless	29 lb	30 lb
Weight With Arms	35 lb	36 lb
Weight Capacity Warranty	300 lb	300 lb





# OnCall

## LIGHT TASK CHAIR AND TASK STOOL

### *High performance, low maintenance.*

Perfect for collaboration spaces, the lightweight OnCall™ task chair and stool feature the collection's signature built-in crescent handle and back cut-out. Mix and match with fabrics from our vast collection for the seat, back or both to create an affordable addition to creative workstations or any impromptu meeting.



**EFFECTIVE DECEMBER 1, 2021**

### Featured Models

#### **GOOD :: \$413**

All plastic, swivel-tilt mechanism, armless, carpet casters

#### **BETTER :: \$471**

Upholstered seat and plastic back, swivel-tilt mechanism, armless, carpet casters, grade 1 textile



#### **BEST :: \$587**

Upholstered seat and back, swivel-tilt mechanism, fixed arms, carpet casters, grade 1 textile



### Features

- Task chair and task stool
- Fully upholstered, upholstered seat or plastic
- Three plastic colors
- Built-in pull handle
- 250 lb weight capacity warranty
- Complements OnCall multipurpose chair and bar stool; see page 239

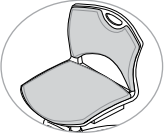
#### 1. Back

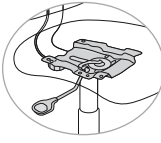

Back and Seat Style	Code	Price	
Plastic	No Code	\$413	
Upholstered Seat Only	US	\$471	
Upholstered Seat and Back	UP	\$529	

#### 2. Mechanism

Mechanism Style	Code	Price	
Basic (Swivel Only)	B	- \$50	
Swivel-Tilt	T	+ \$0	

Swivel-tilt (T) mechanism not available on task stool models (S1/S2).

#### 3. Frame

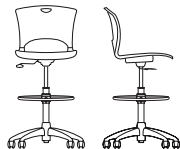

Frame Type	Code	Price	
Task	90T	+ \$0	
Task Stool	90TB S1	+ \$132	
Extended Task Stool	90TB S2	+ \$156	

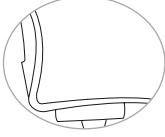
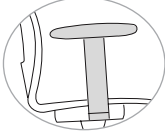

## 4. Arms

Arm Style	Code	Price	
Armless	A0	+ \$0	
Fixed Task	A42	+ \$58	

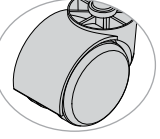
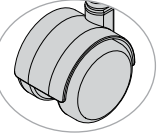
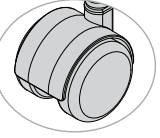
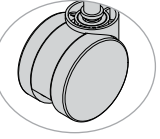
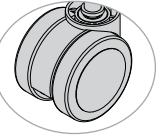
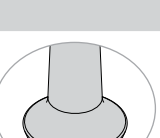
## 5. Base

Casters or Glides	Code	Price	
<b>Casters</b>			
Carpet Casters	C6	+ \$0	
Hard Floor and Carpet Casters	C1	+ \$40	
Self-Locking Carpet Casters	C2	+ \$30	
Self-Locking Hard Floor and Carpet Casters	C7	+ \$61	
Heavy Duty Carpet Casters	C11	+ \$30	
Heavy Duty Hard Floor and Carpet Casters	C9	+ \$61	
<b>Glides</b>			
Glides for Task Chairs	C3	+ \$30	

Self-locking casters (C2/C7) lock only when not in use.

## LIGHT TASK CHAIR AND TASK STOOL

## 6. Material

Protection	Code	Price	
<b>Fire Retardancy</b>			
CAL 133, Fabric, Quantities 1-49	133F	+ \$99	
CAL 133, Fabric, Quantities 50+	133F5	+ \$55	
CAL 133, Plastic, Any Quantity	133P	+ \$45	
<b>Shell Color</b>			
Black	SC1	+ \$0	
Navy	SC5	+ \$0	
Slate	SC8	+ \$0	
<b>Textile</b>			
<b>Seat Textile Only (For US)</b>			
Fabric/Vinyl Grade 1	FG1/VG1	+ \$0	
COM	COM	+ \$22	
Fabric/Vinyl Grade 2	FG2/VG2	+ \$22	
Fabric/Vinyl Grade 3	FG3/VG3	+ \$45	
Fabric/Vinyl Grade 4	FG4/VG4	+ \$77	
Fabric/Vinyl Grade 5	FG5/VG5	+ \$116	
Fabric/Vinyl Grade 6	FG6/VG6	+ \$159	
Fabric/Vinyl Grade 7	FG7/VG7	+ \$200	
<b>Seat and Back Textile (For UP)</b>			
Fabric/Vinyl Grade 1	FG1/VG1	+ \$0	
COM	COM	+ \$34	
Fabric/Vinyl Grade 2	FG2/VG2	+ \$34	
Fabric/Vinyl Grade 3	FG3/VG3	+ \$74	
Fabric/Vinyl Grade 4	FG4/VG4	+ \$121	
Fabric/Vinyl Grade 5	FG5/VG5	+ \$174	
Fabric/Vinyl Grade 6	FG6/VG6	+ \$235	
Fabric/Vinyl Grade 7	FG7/VG7	+ \$296	
<i>Please reference the Textile Reference Guide for pricing on fabric over grade 7. Additional CAL 133 information can be found on page 10.</i>			
<b>7. Packaging</b>			
<b>Packaging</b>			
Back Attached to Seat, Base Separate	UC	+ \$0	
Fully Assembled in a Carton	AC	+ \$120	

**LIGHT TASK CHAIR AND TASK STOOL**

**SPECIFICATIONS**

	90T Task Chair	90T S1 Task Stool	90T S2 Extended Task Stool
<b>Dimensions</b>			
Overall Width	26"	26"	26"
Overall Depth	26.5"	26"	26"
Overall Height	34"	37.5"	41.5"
Seat Width	18"	18"	18"
Seat Depth	17.5"	17.5"	17.5"
Seat Height	16.5"-20.5"	20"-28"	24"-34"
Back Width	19"	19"	19"
Back Height	15"	15"	15"
<b>Materials</b>			
COM	0.8 (US) 0.85 (UP)	0.8 (US) 0.85 (UP)	0.8 (US) 0.85 (UP)
<b>Weight and Capacity</b>			
Weight Armless	26.2 lb	25.5 lb	25.5 lb
Weight With Arms	32.2 lb	29 lb	29 lb
Weight Capacity Warranty	250 lb	250 lb	250 lb



Best

# Orbix

## LIGHT TASK CHAIR AND STOOL

### *Everything you need (and more).*

More design. More comfort. More models to match the needs of any space. The robust build of Orbix features an ultra-supportive and extra-wide backrest with hundreds of diamond-cut perforations for unmatched breathability and comfort.



**EFFECTIVE DECEMBER 1, 2021**

### Featured Models

#### **PLASTIC :: \$350**

Light task chair, plastic seat and back, carpet casters

#### **UPHOLSTERED :: \$408**

Light task chair, upholstered seat, plastic back, carpet casters, grade 1 textile



#### **STOOL :: \$564**

Extended light task stool, upholstered seat, plastic back, carpet casters, grade 1 textile

## Features

- Consistent, cohesive look with a broad statement of line offers options to fit any space
- Upscale style with bold lines and striking detail
- Ultra-supportive, extra-wide backrest provides lasting comfort
- Hundreds of diamond-cut perforations offer unmatched breathability and visual transparency
- Integrated clean-out makes it easy to wipe down
- Collection includes wire rod, bar stool, light task and task stool; see page 243 for the wire rod chair and bar stool
- 14 shell colors to coordinate with optional upholstered seat
- 300 lb weight capacity warranty

### 1. Frame

Frame Type	Code	Price	
Task Chair	1132 FT3 CH1	\$350	
Standard Task Stool	1132 FT3 S21	\$482	
Extended Task Stool	1132 FT3 S22	\$506	

### 2. Seat and Back

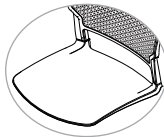
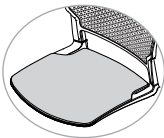
Seat Style	Code	Price	
Plastic	PS	+ \$0	
Upholstered Seat	US	+ \$58	

## LIGHT TASK CHAIR AND STOOL

### 2. Seat and Back (Cont.)

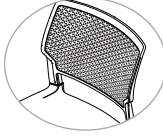
Back Style	Code	Price	
Plastic	PB	+ \$0	

### 3. Arms

Arm Style	Code	Price	
Armless	AR0	+ \$0	

### 4. Base

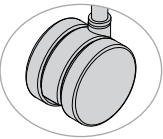
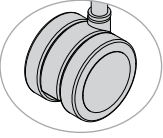
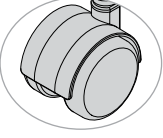
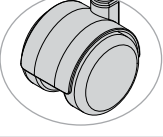
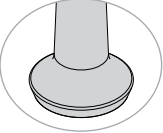
Casters or Glides	Code	Price	
<b>Casters</b>			
Carpet Casters	CS5	+ \$0	
Hard Floor and Carpet Casters	CS6	+ \$40	
Self-Locking Carpet Casters	C20	+ \$30	
Self-Locking Hard Floor and Carpet Casters	C19	+ \$61	
<b>Glides</b>			
Glides for Task Chairs	CS3	+ \$30	

Self-locking casters (C20/C19) lock only when not in use.

## LIGHT TASK CHAIR AND STOOL

### 5. Material

Shell Color	Code	Price	
Apple	SC24	+ \$0	
Arctic	SC21	+ \$0	
Bisque	SC7	+ \$0	
Black	SC1	+ \$0	
Chocolate	SC4	+ \$0	
Latte	SC20	+ \$0	
Lagoon	SC15	+ \$0	
Lemon	SC25	+ \$0	
Navy	SC5	+ \$0	
Pacific	SC22	+ \$0	
Red	SC19	+ \$0	
Slate	SC8	+ \$0	
Sterling	SC18	+ \$0	
Tangerine	SC23	+ \$0	
Seat Textile	Code	Price	
Fabric/Vinyl Grade 1	FG1/VG1	+ \$0	
COM	COM	+\$22	
Fabric/Vinyl Grade 2	FG2/VG2	+\$22	
Fabric/Vinyl Grade 3	FG3/VG3	+\$45	
Fabric/Vinyl Grade 4	FG4/VG4	+\$77	
Fabric/Vinyl Grade 5	FG5/VG5	+\$116	
Fabric/Vinyl Grade 6	FG6/VG6	+\$159	
Fabric/Vinyl Grade 7	FG7/VG7	+\$200	

### 6. Packaging

Packaging	Code	Price	
Back Attached to Seat, Base Separate	UC	+ \$0	
Fully Assembled in a Carton	AC	+ \$120	

### SPECIFICATIONS

	1132 FT3 CH1 Light Task Chair	1132 FT3 S21 Light Task Stool	1132 FT3 S22 Extended Task Stool
<b>Dimensions</b>			
Overall Width Armless	28.25"	28.25"	28.25"
Overall Depth	27.25"	27.25"	27.25"
Overall Height	32.75"-37"	36.25"-43.25"	39"-48.75"
Seat Width	18.25"	18.25"	18.25"
Seat Depth	17.25"	17.25"	17.25"
Seat Height	17.5"-22.75"	21"-28"	23.25"-33.75"
Back Width	19.75"	19.75"	19.75"
Back Height	17.5"	17.5"	17.5"
<b>Materials</b>			
COM	0.75 yd	0.75 yd	0.75 yd
<b>Weight and Capacity</b>			
Weight Armless	26 lb (PS) 27 lb (US)	3 lb (PS) 32 lb (US)	31 lb (PS) 32 lb (US)
Weight Capacity Warranty	300 lb	300 lb	300 lb

*Plastic seat (PS). Upholstered seat (US).*



# Prava

## CONFERENCE CHAIR

### *Command performance.*

The Jorge Pensi designed Prava™ chair has double-stitched detailing and revolutionary molded-foam construction. The midback model is ideal for conference room use while the highback is well suited for any executive. A plush foam cushion in the center of the backrest offers ultimate comfort. A wide array of comfort and control options are available including three arm styles, choice of swivel-tilt, knee tilt or enhanced synchro adjustments. Modern and sophisticated with restrained elegance, Prava embodies the precise balance between refinement and comfort.



EFFECTIVE DECEMBER 1, 2021

### Featured Models

#### **GOOD :: \$856**

Midback, swivel-tilt mechanism  
black fixed loop arms, black nylon  
base, carpet casters, grade 1 textile

#### **BETTER :: \$889**

Midback, knee-tilt mechanism, fixed  
loop black nylon arms, black nylon  
base, carpet casters, grade 1 textile

#### **BEST :: \$1,151**

Highback, enhanced synchro  
mechanism, fully adjustable black  
nylon arms, polished aluminum base,  
carpet casters, grade 1 textile



### Features

- Sleek European styling
- Soft, plush foam back
- Perimeter foam for a tailored profile
- Jorge Pensi design
- Double-stitch detailing
- Aluminum accents
- Waterfall seat
- 300 lb weight capacity warranty

#### 1. Back

Back Size and Style	Code	Price	
---------------------	------	-------	--

Midback

6422

\$889

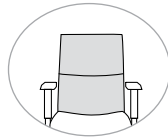

Highback

6423

\$921

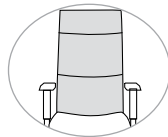

Back Options	Code	Price	
--------------	------	-------	--

Headrest,  
Matches Chair Textile

HR1C0

+ \$95

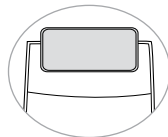

*Headrest is available on highback models only.*

#### 2. Mechanism

Mechanism Style	Code	Price	
-----------------	------	-------	--

Swivel-Tilt

T

- \$33



Knee-Tilt

K

+ \$0



Enhanced Synchro

Y

+ \$57

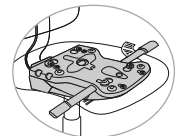

Enhanced Synchro With  
Seat-Depth Adjustment

Y E3

+ \$136

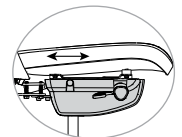

#### 3. Arms

Arm Style	Code	Price	
-----------	------	-------	--

Armless

A0

- \$75

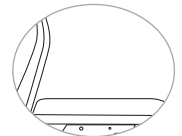

Black Fixed Loop

A111

+ \$0



Silver Fixed Metallic Loop

A112

+ \$74

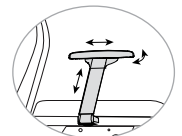

Fully Adjustable  
Black (6-Way)

AR8

+ \$60

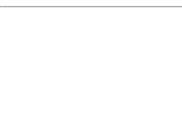

## 4. Base

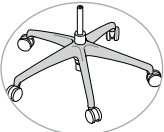
Base Color and Material	Code	Price	
Black Nylon Base	B0	+ \$0	
Silver Metallic Base	B11	+ \$113	
Polished Aluminum Base	B3	+ \$113	
Brushed Aluminum Base	B8	+ \$113	

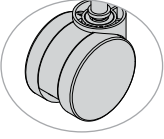
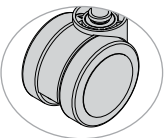
Casters	Code	Price	
Carpet Casters	C21	+ \$0	
Hard Floor and Carpet Casters	C22	+ \$40	

### For Aluminum Bases (B3/B8) Only

Carpet Casters	C16	+ \$0	
Hard Floor and Carpet Casters	C17	+ \$40	
Self-Locking Carpet Casters	C20	+ \$30	
Self-Locking Hard Floor and Carpet Casters	C19	+ \$64	

Self-locking casters (C19/C20) lock only when not in use.

## CONFERENCE CHAIR

## 5. Material

Protection	Code	Price	
<b>Fire Retardancy</b>			
CAL 133, Fabric, Quantities 1-49	133F	+ \$99	
CAL 133, Fabric, Quantities 50+	133F5	+ \$55	
CAL 133, Leather, Any Quantity	133L	+ \$119	
Seat and Back Textile	Code	Price	
Fabric/Vinyl Grade 1	FG1/VG1	+ \$0	
COM	COM	+ \$36	
Fabric/Vinyl Grade 2	FG2/VG2	+ \$36	
Fabric/Vinyl Grade 3	FG3/VG3	+ \$78	
Fabric/Vinyl Grade 4	FG4/VG4	+ \$135	
Fabric/Vinyl Grade 5	FG5/VG5	+ \$196	
Fabric/Vinyl Grade 6	FG6/VG6	+ \$263	
Fabric/Vinyl Grade 7	FG7/VG7	+ \$332	
Leather Grade 1	LG1	+ \$340	
COL	COL	+ \$460	
Leather Grade 2	LG2	+ \$460	
Leather Grade 3	LG3	+ \$600	

Please reference the *Textile Reference Guide* for pricing on fabric over grade 7 and leather over grade 3. Additional CAL 133 information can be found on page 10.

## 6. Packaging

Packaging	Code	Price	
Knocked Down	KD	+ \$0	
Back Attached to Seat, Base Separate	UC	+ \$80	
Fully Assembled in a Carton	AC	+ \$200	

EFFECTIVE DECEMBER 1, 2021 | GSA SIN #: 33721

**SPECIFICATIONS**

	6422 Midback	6423 Highback
<b>Dimensions</b>		
Overall Width Armless	19"	19"
Overall Width With Arms	26.75"	26.75"
Overall Depth	26.3"	26.3"
Overall Height	43.125"	46.125"
Seat Width	19"	19"
Seat Depth	19"	19"
Seat Height	17.625"-20.625" (T/K) 19"-22" (Y)	17.5"-20.5" (T/K) 19"-22" (Y)
Back Width	18.25"	18.25"
Back Height	23.75"	26.75"
<b>Materials</b>		
COM	2 yd	2.25 yd
COL	35 sq ft	40 sq ft
<b>Weight and Capacity</b>		
Weight Armless	42 lb	44 lb
Weight With Arms	50 lb	52 lb
Weight Capacity Warranty	300 lb	300 lb

Swivel-tilt mechanism (T). Knee-tilt mechanism (K). Enhanced synchro mechanism (Y).



Good

# ReAlign

## TASK CHAIR

*When sleek contour  
and control align.*

Contemporary tailored lines, a thin profile and enduring comfort make ReAlign™ a perfect chair for both task and conference use. The sculpted, ergonomically designed back and backsheight adjustment provide lumbar support in both midback and highback styles. Seatsdepth adjustment, ballistic nylon back and a Heavy Duty 24/7 option expand the versatility of this collection. With five control mechanisms and five arm styles to choose from, ReAlign can solve almost any office requirement.



*Best*

**EFFECTIVE DECEMBER 1, 2021**

### Featured Models

**GOOD :: \$773**

Midback, swivel-tilt mechanism, height-adjustable arms, black nylon base, carpet casters, grade 1 textile

**BETTER :: \$863**

Midback, enhanced synchro mechanism, height-adjustable arms, black nylon base, carpet casters, grade 1 textile

**BEST :: \$993**

Highback, enhanced synchro mechanism, fixed loop arms, high profile polished aluminum base, carpet casters, grade 1 vinyl

### Features

- Thin profile design
- Ergonomic concave/convex back
- Internal back height adjustment (on Y & M mechanism only)
- Back height adjustment
- CAL 133 approved models
- 300 lb weight capacity warranty; 350 lb Heavy Duty 24/7 weight capacity warranty

#### 1. Back

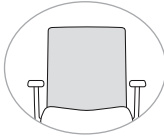
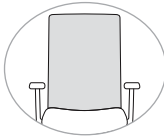

Back Size and Style	Code	Price	
Midback	681	\$863	
Highback	682	\$895	

#### 2. Heavy Duty

Heavy Duty Series	Code	Price	
Heavy Duty	HD	+ \$126	

Heavy Duty option only compatible with multi-function (M), enhanced synchro (Y) and euro glide (A2) mechanisms. See page 536 for additional LT and HD options.

#### 3. Mechanism

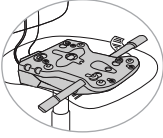
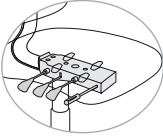
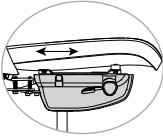
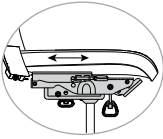
Mechanism Style	Code	Price	
Basic (Swivel Only)	B	- \$127	
Swivel-Tilt	T	- \$90	
Knee-Tilt	K	- \$57	
Enhanced Synchro	Y	+ \$0	
Multi-Function	M	+ \$36	
Enhanced Synchro With Seat-Depth Adjustment	Y E3	+ \$79	
Multi-Function With Seat-Depth Adjustment	M E3	+ \$115	

## 4. Arms

Arm Style	Code	Price	
Armless	A0	- \$90	
Fixed Loop	A77	- \$15	
Height-Adjustable	A73	+ \$0	
Height-Adjustable With Pivot	A75	+ \$10	
Height-/Width-Adjustable	A74	+ \$25	
Height-/Width-Adjustable With Pivot	A76	+ \$45	

## TASK CHAIR

## 5. Base

Base Color and Material	Code	Price	
Black Nylon Base	B0	+ \$0	
Heavy Duty Black Nylon Base, 26" (For HD)	B7	+ \$0	
High Profile Polished Aluminum Base	B3	+ \$113	
Low Profile Base With Higher Cylinder	S8	+ \$0	

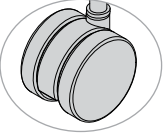
Casters or Glides	Code	Price	
<b>Casters</b>			
Carpet Casters	C15	+ \$0	
Hard Floor and Carpet Casters	C14	+ \$40	
Self-Locking Carpet Casters	C20	+ \$30	
Self-Locking Hard Floor and Carpet Casters	C19	+ \$64	

High profile polished aluminum base (B3) is not available with seat-depth adjustment (E3).

## 5. Base (Cont.)

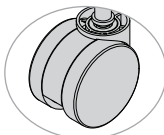
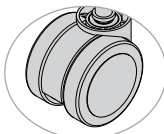
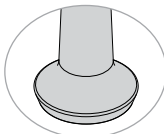
Casters or Glides	Code	Price	
<b>Heavy Duty Casters</b>			
Heavy Duty Carpet Casters	C11	+ \$0	
Heavy Duty Hard Floor and Carpet Casters	C9	+ \$61	
<b>Glides</b>			
Glides for Task Chairs	C3	+ \$30	

Higher cylinder (S8) must use enhanced synchro mechanism (Y) and is only available with low profile base and corresponding casters.

Self-locking casters (C20/C19) lock only when not in use. Heavy Duty casters must use enhanced synchro (Y) mechanism.

## 6. Material

Protection	Code	Price	
CAL 133, Fabric, Quantities 1-49	133F	+ \$99	
CAL 133, Fabric, Quantities 50+	133F5	+ \$55	
CAL 133, Leather, Any Quantity	133L	+ \$119	
Ballistic Nylon	Code	Price	
Ballistic Nylon Back	BN	+ \$0	
Seat and Back Textile	Code	Price	
Fabric/Vinyl Grade 1	FG1/VG1	+ \$0	
COM	COM	+ \$36	
Fabric/Vinyl Grade 2	FG2/VG2	+ \$36	
Fabric/Vinyl Grade 3	FG3/VG3	+ \$78	
Fabric/Vinyl Grade 4	FG4/VG4	+ \$135	
Fabric/Vinyl Grade 5	FG5/VG5	+ \$196	
Fabric/Vinyl Grade 6	FG6/VG6	+ \$263	
Fabric/Vinyl Grade 7	FG7/VG7	+ \$332	
Leather Grade 1	LG1	+ \$340	
COL	COL	+ \$460	
Leather Grade 2	LG2	+ \$460	
Leather Grade 3	LG3	+ \$600	

Please reference the Textile Reference Guide for pricing on fabric over grade 7 and leather over grade 3.

## TASK CHAIR

## 7. Packaging

Packaging	Code	Price
Knocked Down	KD	+ \$0
Back Attached to Seat, Base Separate	UC	+ \$80
Fully Assembled in Carton	AC	+ \$200

## SPECIFICATIONS

	681 Midback Task Chair	682 Highback Task Chair
<b>Dimensions</b>		
Overall Width	27"	27"
Overall Depth	27"	27"
Overall Height	37.5"	40.5"
Seat Width	19"	19"
Seat Depth	19"	19"
Seat Height (Mechanism)	17"-20" (B) 16.625"-19.75" (T) 16.75"-20.25" (K) 16.5"-20" (I) 16.75"-20.25" (Y/M/A2)	17"-20" (B) 16.625"-19.75" (T) 16.75"-20.25" (K) 16.5"-20" (I) 16.75"-20.25" (Y/M/A2)
Back Width	19"	19"
Back Height	23"	26"
<b>Materials</b>		
COM	2 yd 1.7 yd (BN)	2.2 yd 1.75 yd (BN)
COL	34 sq ft 30 sq ft (BN)	40 sq ft 32 sq ft (BN)
<b>Weight and Capacity</b>		
Weight Armless (Mechanism)	38 lb (B) 41 lb (T) 49 lb (K) 49 lb (Y/M)	39 lb (B) 42 lb (T) 50 lb (K) 50 lb (Y/M)
Weight With Arms	45 lb (B) 48 lb (T) 56 lb (K) 56 lb (Y/M)	46 lb (B) 49 lb (T) 57 lb (K) 57 lb (Y/M)
Weight	300 lb	300 lb
Capacity Warranty	350 lb (HD)	350 lb (HD)

Basic mechanism (B). Swivel-tilt mechanism (T). Knee-tilt mechanism (K). Enhanced synchro mechanism (Y). Multi-function mechanism (M). Ballistic nylon back (BN). Heavy Duty (HD).

# ReAlign

## TASK STOOL

*When sleek contour and control align.*

Contemporary tailored lines, a thin profile and enduring comfort make ReAlign™ a perfect stool for task use. The sculpted, ergonomically designed back and back height-adjustment provide lumbar support in both midback and highback styles. Seat-depth adjustment and ballistic nylon back expand the versatility of this collection. With five arm styles to choose from, ReAlign can solve almost any of office requirement.



**EFFECTIVE DECEMBER 1, 2021**

### Featured Models

**GOOD :: \$822**

Midback stool, basic mechanism, armless, black nylon base, grade 1 textile

**BETTER :: \$912**

Midback stool, basic mechanism, height-adjustable arms, black nylon base, grade 1 textile

**BEST :: \$1,094**

Midback stool, basic mechanism, height-/width-adjustable arms with pivot, extended stool kit, high profile polished aluminum base, grade 1 textile



## Features

- Thin profile design
- Ergonomic concave/convex back
- 300 lb weight capacity warranty;  
350 lb Heavy Duty 24/7 weight capacity warranty

### 1. Back

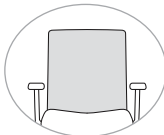
Back Size and Style	Code	Price	
Midback	681B	\$912	

*ReAlign task stool (681B) comes with basic mechanism (swivel only).*

### 2. Mechanism

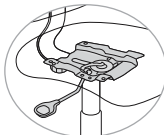

Mechanism Style	Code	Price	
Basic (Swivel Only)	B	+ \$0	

## TASK STOOL

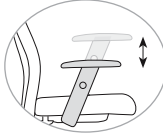
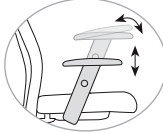
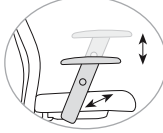
### 3. Arms

Arm Style	Code	Price	
Armless	A0	- \$90	
Fixed Loop	A77	- \$15	
Height-Adjustable	A73	+ \$0	
Height-Adjustable With Pivot	A75	+ \$10	
Height-/Width-Adjustable	A74	+ \$25	
Height-/Width-Adjustable With Pivot	A76	+ \$45	

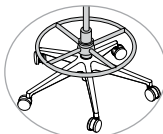
### 4. Base

Stool Kit	Code	Price	
Standard Stool Kit	S1	+ \$0	
Extended Stool Kit	S2	+ \$24	

Base Color and Material	Code	Price	
Standard Black Nylon Base	N	+ \$0	
High Profile Polished Aluminum Base	B3	+ \$113	

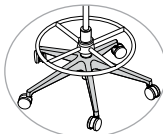
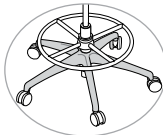
## 4. Base (Cont.)

Casters or Glides	Code	Price	
<b>Casters</b>			
Carpet Casters	C15	+ \$0	
Hard Floor and Carpet Casters	C14	+ \$40	
Self-Locking Carpet Casters	C20	+ \$30	
Self-Locking Hard Floor and Carpet Casters	C19	+ \$64	
<b>Glides</b>			
Glides for Task Chairs	C3	+ \$30	

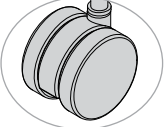
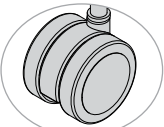
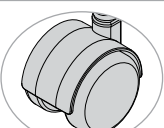
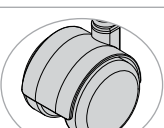
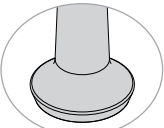
Self-locking casters (C19/C20) lock only when not in use.

## 5. Material

Protection	Code	Price	
<b>Fire Retardancy</b>			
CAL 133, Fabric, Quantities 1–49	133F	+ \$99	
CAL 133, Fabric, Quantities 50+	133F5	+ \$55	
CAL 133, Leather, Any Quantity	133L	+ \$119	
<b>Ballistic Nylon</b>			
Ballistic Nylon Back	BN	+ \$0	

## TASK STOOL

## 5. Material (Cont.)

Seat and Back Textile	Code	Price	
Fabric/Vinyl Grade 1	FG1/VG1	+ \$0	
COM	COM	+ \$36	
Fabric/Vinyl Grade 2	FG2/VG2	+ \$36	
Fabric/Vinyl Grade 3	FG3/VG3	+ \$78	
Fabric/Vinyl Grade 4	FG4/VG4	+ \$135	
Fabric/Vinyl Grade 5	FG5/VG5	+ \$196	
Fabric/Vinyl Grade 6	FG6/VG6	+ \$263	
Fabric/Vinyl Grade 7	FG7/VG7	+ \$332	
Leather Grade 1	LG1	+ \$340	
COL	COL	+ \$460	
Leather Grade 2	LG2	+ \$460	
Leather Grade 3	LG3	+ \$600	

Please reference the Textile Reference Guide for pricing on fabric over grade 7 and leather over grade 3. Additional CAL 133 information can be found on page 10.

## 6. Packaging

Packaging	Code	Price	
Knocked Down	KD	+ \$0	
Back Attached to Seat, Base Separate	UC	+ \$80	
Fully Assembled in Carton	AC	+ \$200	

## SPECIFICATIONS

	681B S1 Task Stool	681B S2 Extended Task Stool
<b>Dimensions</b>		
Overall Width	27"	27"
Overall Depth	27"	27"
Overall Height	41.25"–49.25"	45.25"–56.38"
Seat Width	19"	19"
Seat Depth	19"	19"
Seat Height	21.5"–29.5"	25.5"–33.5"
Back Width	19"	19"
Back Height	23"	23"
<b>Materials</b>		
COM	2 yd 1.7 yd (BN)	2 yd 1.7 yd (BN)
COL	34 sq ft 30 sq ft (BN)	40 sq ft 32 sq ft (BN)
<b>Weight and Capacity</b>		
Weight Armless	38 lb	39 lb
Weight With Arms	45 lb	46 lb
Weight Capacity Warranty	300 lb	300 lb

Ballistic nylon back (BN).

# Relay

## LIGHT TASK CHAIR AND TASK STOOL

### *Durable and adaptable to the finish.*

Great to look at, Relay™ provides lasting comfort in a stylish design that makes an appealing multipurpose seating option for meeting, training, conference and break rooms. The seat and back are molded from high-impact thermoplastic for lasting durability and comfort. Add the optional upholstered seat and back for a more sophisticated, inviting look and added comfort.



**EFFECTIVE DECEMBER 1, 2021**

### Featured Models

#### **GOOD :: \$478**

Light task chair, plastic seat and back, basic mechanism, armless, carpet casters

#### **BETTER :: \$586**

Light task chair, upholstered seat and plastic back, swivel-tilt mechanism, armless, carpet casters, grade 1 textile



#### **BEST :: \$702**

Light task chair, upholstered seat and back, swivel-tilt mechanism, fixed arms cantilever, carpet casters, grade 1 textile

## Features

- Structurally reinforced and durable back
- High-impact polypropylene
- Fully upholstered, upholstered seat or plastic
- Nine plastic colors
- 250 lb weight capacity warranty
- Complements Relay multipurpose and nester chairs; see page 254

### 1. Back

Back and Seat Style	Code	Price	
Plastic	No Code	\$528	
Upholstered Seat Only	US	\$586	
Upholstered Seat and Back	UP	\$644	

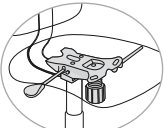

### 2. Mechanism

Mechanism Style	Code	Price	
Basic (Swivel Only)	B	-\$50	
Swivel-Tilt	T	+\$0	

Swivel-tilt (T) mechanism not available with task stool (S1) or extended task stool (S2).



## LIGHT TASK CHAIR AND TASK STOOL

### 3. Frame

Frame Type	Code	Price	
Task Chair	94T	+\$0	
Task Stool	94B S1	+\$132	
Extended Task Stool	94B S2	+\$156	

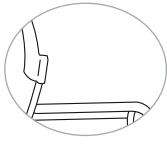

## 4. Arms

Arm Style	Code	Price	
Armless	A0	+ \$0	
Fixed Cantilever	A60	+ \$58	

## 5. Base

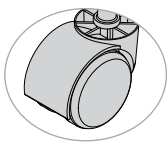
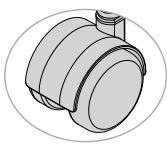
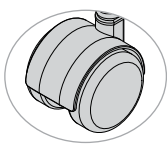
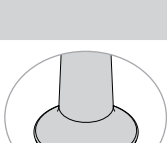
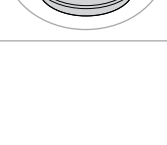
Casters or Glides	Code	Price	
<b>Casters</b>			
Carpet Casters	C6	+ \$0	
Hard Floor and Carpet Casters	C1	+ \$40	
Self-Locking Carpet Casters	C2	+ \$30	
Self-Locking Hard Floor and Carpet Casters	C7	+ \$61	
<b>Glides</b>			
Glides for Task Chairs	C3	+ \$30	

Self-locking casters lock only when not in use.

## LIGHT TASK CHAIR AND TASK STOOL

## 6. Material

Protection	Code	Price	
<b>Fire Retardancy</b>			
CAL 133, Fabric, Quantities 1-49	133F	+ \$99	
CAL 133, Fabric, Quantities 50+	133F5	+ \$55	
CAL 133, Plastic, Any Quantity	133P	+ \$45	
<b>Shell Color</b>			
Arctic	SC21	+ \$0	
Black	SC1	+ \$0	
Chocolate	SC4	+ \$0	
Lagoon	SC15	+ \$0	
Latte	SC20	+ \$0	
Navy	SC5	+ \$0	
Red	SC19	+ \$0	
Slate	SC8	+ \$0	
Sterling	SC18	+ \$0	
<b>Textile</b>			
<b>Seat Textile (US)</b>			
Fabric/Vinyl Grade 1	FG1/VG1	+ \$0	
COM	COM	+ \$22	
Fabric/Vinyl Grade 2	FG2/VG2	+ \$22	
Fabric/Vinyl Grade 3	FG3/VG3	+ \$45	
Fabric/Vinyl Grade 4	FG4/VG4	+ \$77	
Fabric/Vinyl Grade 5	FG5/VG5	+ \$116	
Fabric/Vinyl Grade 6	FG6/VG6	+ \$159	
Fabric/Vinyl Grade 7	FG7/VG7	+ \$200	
<b>Seat and Back Textile (UP)</b>			
Fabric/Vinyl Grade 1	FG1/VG1	+ \$0	
COM	COM	+ \$34	
Fabric/Vinyl Grade 2	FG2/VG2	+ \$34	
Fabric/Vinyl Grade 3	FG3/VG3	+ \$74	
Fabric/Vinyl Grade 4	FG4/VG4	+ \$121	
Fabric/Vinyl Grade 5	FG5/VG5	+ \$174	
Fabric/Vinyl Grade 6	FG6/VG6	+ \$235	
Fabric/Vinyl Grade 7	FG7/VG7	+ \$296	

Please reference the *Textile Reference Guide* for pricing on fabric over grade 7. Additional CAL 133 information can be found on page 10.

### 7. Packaging

Packaging	Code	Price
Back Attached to Seat, Base Separate	UC	+ \$0
Fully Assembled in Carton	AC	+ \$120

### SPECIFICATIONS

	94T Light Task Chair	94B S1 Light Task Stool	94B S2 Extended Light Task Stool
<b>Dimensions</b>			
Overall Width	26"	26"	26"
Overall Depth	26"	26"	26"
Overall Height	32.25"–37.25"	35.25"	39.25"
Seat Width	18.25"	20.5"	20.5"
Seat Depth	17.25"	18"	18"
Seat Height	17"–22"	20.625"–27"	23.5"–33.50"
Back Width	19.125"	19.125"	19.125"
Back Height	17"	17"	17"
<b>Materials</b>			
COM	0.75 yd (US) 1 yd (UP)	0.75 yd (US) 1 yd (UP)	0.75 yd (US) 1 yd (UP)
<b>Weight and Capacity</b>			
Weight Armless	27 lb	31 lb	32 lb
Weight With Arms	28 lb	32 lb	33 lb
Weight Capacity Warranty	250 lb	250 lb	250 lb

*Upholstered seat (US). Upholstered seat and back (UP).*



Best

# Rio

## LIGHT TASK CHAIR AND TASK STOOL

### *Design that responds to you.*

What goes into the award-winning line of Rio® plastic chairs? Patented flexing technology, for one.

Our complete family of Rio models feature our patented Active Rebound Control (ARC) Technology®—a performance-minded flexor insert that supports a wide range of motion (20 full degrees to be exact) and responds precisely to the amount of weight pressed against it.

Add a fresh, modern color palette and you've got a seating solution that allows for more movement, day-long comfort and flexibility than any other chair in its class.



**EFFECTIVE DECEMBER 1, 2021**

### Featured Models

#### **GOOD :: \$383**

Light task chair, plastic seat and back, basic mechanism, armless, black frame, black base, carpet casters

#### **BETTER :: \$441**

Light task chair, upholstered seat and plastic back, basic mechanism, armless, black frame, black base, carpet casters, grade 1 textile



#### **BEST :: \$592**

Light task chair, upholstered seat and back, basic mechanism, fixed arms, silver frame, fog base, carpet casters, grade 1 textile



## Features

- Exceptional support and comfort
- Fully upholstered, upholstered seat or plastic
- ARC Technology® for weight-assisted flex
- 14 plastic shell colors
- Two frame finishes with matching arm pads
- Easy-grip edge that acts as a pull handle
- Clean-out space
- 300 lb weight capacity warranty
- Complements Rio multipurpose chair counter and bar stool; see page 257

### 1. Back

Back and Seat Style	Code	Price	
Plastic Seat and Back	PS	\$383	
Upholstered Seat Only	US	\$441	
Upholstered Seat and Back	UP	\$499	

### 2. Frame

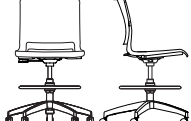
Frame Type	Code	Price	
Task Chair	1052 FT3	+ \$0	
Task Stool	1052 FT3 S21	+ \$132	
Extended Task Stool	1052 FT3 S22	+ \$156	



Frame Finish	Code	Price	
Black	FC1	+ \$0	
Silver	FC2	+ \$35	

*Rio task models available with basic (swivel) mechanism only.*





**3. Arms**

Arm Style	Code	Price	
Armless	A0	+ \$0	
Fixed	A91	+ \$58	

Arms, if specified, are black for black frames and fog for silver frames.

**4. Base**

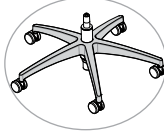
Base Color and Material	Code	Price	
Black Nylon Base (For Black Frame FC1)	B17	+ \$0	
Fog Nylon Base (For Silver Frame FC2)	B21	+ \$0	

Casters or Glides	Code	Price	
<b>Casters</b>			

Carpet Casters	C15	+ \$0	
----------------	-----	-------	---

Hard Floor and Carpet Casters	C14	+ \$40	
-------------------------------	-----	--------	---

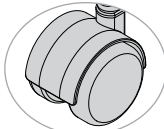
Self-Locking Carpet Casters	C20	+ \$30	
-----------------------------	-----	--------	---

Self-Locking Hard Floor and Carpet Casters	C19	+ \$64	
--	-----	--------	---

**Glides**

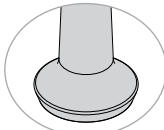
Glides for Task Chairs	C3	+ \$30	
------------------------	----	--------	---

Self-locking casters (C19/C20) lock only when chair is not in use.

**5. Material**

Protection	Code	Price	
<b>Fire Retardancy</b>			
CAL 133, Fabric, Quantities 1-49	133F	+ \$64	
CAL 133, Fabric, Quantities 50+	133F5	+ \$20	
CAL 133, Plastic, Any Quantity	133P	+ \$10	

Shell Color (For PS and US)	Code	Price	
Apple	SC24	+ \$0	
Arctic	SC21	+ \$0	
Bisque	SC7	+ \$0	
Black	SC1	+ \$0	
Chocolate	SC4	+ \$0	
Lagoon	SC15	+ \$0	
Latte	SC20	+ \$0	
Lemon	SC25	+ \$0	
Navy	SC5	+ \$0	
Pacific	SC22	+ \$0	
Red	SC19	+ \$0	
Slate	SC8	+ \$0	
Sterling	SC18	+ \$0	
Tangerine	SC23	+ \$0	

Textile	Code	Price	
<b>Seat Textile Only (For US)</b>			
Fabric/Vinyl Grade 1	FG1/VG1	+ \$0	
COM	COM	+ \$22	
Fabric/Vinyl Grade 2	FG2/VG2	+ \$22	
Fabric/Vinyl Grade 3	FG3/VG3	+ \$45	
Fabric/Vinyl Grade 4	FG4/VG4	+ \$77	
Fabric/Vinyl Grade 5	FG5/VG5	+ \$116	
Fabric/Vinyl Grade 6	FG6/VG6	+ \$159	
Fabric/Vinyl Grade 7	FG7/VG7	+ \$200	

<b>Seat and Back Textile (UP)</b>			
Fabric/Vinyl Grade 1	FG1/VG1	+ \$0	
COM	COM	+ \$34	
Fabric/Vinyl Grade 2	FG2/VG2	+ \$34	
Fabric/Vinyl Grade 3	FG3/VG3	+ \$74	
Fabric/Vinyl Grade 4	FG4/VG4	+ \$121	
Fabric/Vinyl Grade 5	FG5/VG5	+ \$174	
Fabric/Vinyl Grade 6	FG6/VG6	+ \$235	
Fabric/Vinyl Grade 7	FG7/VG7	+ \$296	

Please reference the *Textile Reference Guide* for pricing on fabric over grade 7. Additional CAL 133 information can be found on page 10.

**6. Packaging**

Packaging	Code	Price
Back Attached to Seat, Base Separate	UC	+ \$0
Fully Assembled in a Carton	AC	+ \$120

**SPECIFICATIONS**

	1052 Light Task Chair	1052 S21 Light Task Stool	1052 S22 Extended Light Task Stool
<b>Dimensions</b>			
Overall Width	27"	27"	27"
Overall Depth	27"	27"	27"
Overall Height	31.9"-36.9"	37.9"-45.9"	41.9"-51.9"
Seat Width	18.5"	18.5"	18.5"
Seat Depth	18.2"	18.2"	18.2"
Seat Height	16.62"-21.75"	18"-26"	23"-33"
Back Width	17.5"	17.5"	17.5"
Back Height	18.2"	18.2"	18.2"
<b>Materials</b>			
COM	0.85 yd (US) 1 yd (UP)	0.85 yd (US) 1 yd (UP)	0.85 yd (US) 1 yd (UP)
<b>Weight and Capacity</b>			
Weight Armless	20.5 lb	25.1 lb	26 lb
Weight With Arms	22.2 lb	26.8 lb	27.7 lb
Weight Capacity Warranty	300 lb	300 lb	300 lb

*Upholstered seat (US). Upholstered seat and back (UP).*



*Best*

# Sona

## CONFERENCE CHAIR

### *Meet in harmony.*

Create contemporary conference rooms with the distinct style of Sona™. This up-to-any-task chair surrounds your tables with smart, sleek and slim lines while powering productivity with essential ergonomic engineering.



**EFFECTIVE DECEMBER 1, 2021**

### Featured Models

#### **GOOD :: \$842**

Knit back, swivel-tilt mechanism, open loop black arms, black nylon base, grade 1 textile

#### **BETTER :: \$935**

Knit-back, knee-tilt mechanism, fully adjustable black arms (6-way), black nylon base, grade 1 textile

#### **BEST :: \$1,151**



Upholstered back, enhanced synchro mechanism, open loop silver metallic arms, silver metallic base, silver metallic pull handle, grade 1 textile

## Features

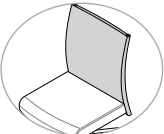

- Settle in with lumbar curve and height-adjustable back
- Add style and texture with 11 airy knit meshes
- 300 lb weight capacity warranty

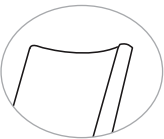
### 1. Back

Back Size and Style	Code	Price	
Knit Back	5723 B7	\$935	
Upholstered Back	5723 B8	\$935	

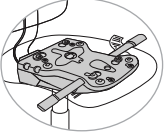
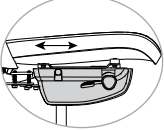

Back Options	Code	Price	
No Pull Handle	PH0	+\$0	
Black Nylon Pull Handle	PH1	+\$26	
Silver Metallic Pull Handle	PH2	+\$32	

### 2. Mechanism

Mechanism	Code	Price	
Swivel-Tilt	T	-\$33	
Knee-Tilt	K	+\$0	
Enhanced Synchro	Y	+\$57	
Enhanced Synchro With Seat-Depth Adjustment	Y E3	+\$136	

## CONFERENCE CHAIR

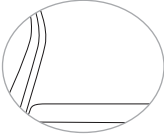
### 3. Arms

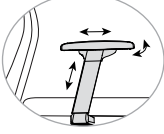
Arm Style	Code	Price	
Armless	A0	-\$135	
Fixed Black Open Loop	A111	-\$60	
Fixed Silver Metallic Open Loop	A112	+\$14	
Fully Adjustable Black (6-Way)	AR8	+\$0	

### 4. Base

Base Color and Material	Code	Price	
Black Nylon Base	B0	+\$0	
Silver Metallic Base	B10	+\$113	
Polished Aluminum Base	B3	+\$113	
Brushed Aluminum Base	B25	+\$113	
Low Profile Base With Higher Cylinder	S8	+\$0	

High cylinder with low profile base (S8) is available with enhanced synchro (Y) mechanism only.

## 4. Base (Cont.)

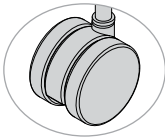
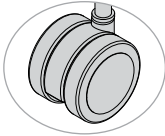
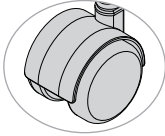
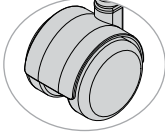
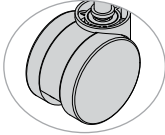
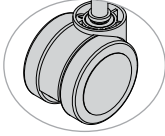
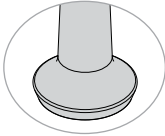
Casters or Glides	Code	Price	
<b>Casters</b>			
Carpet Casters	C16	+ \$0	
Hard Floor and Carpet Casters	C17	+ \$40	
Self-Locking Carpet Casters	C20	+ \$30	
Self-Locking Hard Floor and Carpet Casters	C19	+ \$64	
<b>Casters for Low Profile Base With Higher Cylinder (\$8)</b>			
Carpet Casters	C21	+ \$0	
Hard Floor and Carpet Casters	C22	+ \$40	
<b>Glides</b>			
Glides for Task Chairs	C3	+ \$30	

Self-locking casters (C19/C20) lock only when chair is not in use.

## 5. Material

Protection	Code	Price	
<b>Fire Retardancy</b>			
CAL 133, Fabric, Quantities 1-49	133F	+ \$99	
CAL 133, Fabric, Quantities 50+	133F5	+ \$55	
CAL 133, Leather, Any Quantity	133L	+ \$119	

## CONFERENCE CHAIR

### 5. Material

Knit Color	Code	Price	
<b>Textured Knit</b>			
Black	KP10	+ \$0	
Cool Gray	KP11	+ \$0	
Dune	KP13	+ \$0	
Forest	KP14	+ \$0	
Merlot	KP16	+ \$0	
Mocha	KP12	+ \$0	
Ocean	KP15	+ \$0	
<b>Twin Knit</b>			
Licorice	KP23	+ \$0	
Shadow	KP22	+ \$0	
Toffee	KP20	+ \$0	
Winter Gray	KP21	+ \$0	



Better

## CONFERENCE CHAIR

### 5. Material

Textile (For Both B7 and B8)	Code	Price
Fabric/Vinyl Grade 1	FG1/VG1	+ \$0
COM	COM	+ \$34
Fabric/Vinyl Grade 2	FG2/VG2	+ \$34
Fabric/Vinyl Grade 3	FG3/VG3	+ \$74
Fabric/Vinyl Grade 4	FG4/VG4	+ \$121
Fabric/Vinyl Grade 5	FG5/VG5	+ \$174
Fabric/Vinyl Grade 6	FG6/VG6	+ \$235
Fabric/Vinyl Grade 7	FG7/VG7	+ \$296
Leather Grade 1	LG1	+ \$260
COL	COL	+ \$320
Leather Grade 2	LG2	+ \$320
Leather Grade 3	LG3	+ \$400

Please reference the *Textile Reference Guide* for pricing on fabric over grade 7 and leather over grade 3. Additional CAL 133 information can be found on page 10.



### 6. Packaging

Packaging	Code	Price
Knocked Down	KD	+ \$0
Back Attached to Seat, Base Separate	UC	+ \$80
Fully Assembled in a Carton	AC	+ \$200

### SPECIFICATIONS

5723 Conference Chair	
<b>Dimensions</b>	
Overall Width	27"
Overall Depth	25"
Overall Height	37"-43.5"
Seat Width	19"
Seat Depth	18"
Seat Height	17.5"-20.5"
Back Width	19"
Back Height	25"
<b>Materials</b>	
COM	1 yd (B7) 1.75 yd (B8)
COL	17 sq ft (B7) 32 sq ft (B8)
<b>Weight and Capacity</b>	
Weight Armless	46 lb
Weight With Arms	52 lb
Weight Capacity Warranty	300 lb

Knit back (B7). Upholstered back (B8).

# Torsa

## TASK CHAIR

### *Inspired by nature.*

Cutting-edge design and the ability to personalize frame, arm, and mesh color combinations make Torsa™ the natural preference for a fresh, clean style. The innovative cable-driven synchro mechanism with Comfort Drive® allows easy fingertip adjustment from a seated position. And remarkably, excellent ergonomics come standard with adjustable lumbar support and seat-depth adjustment.



**EFFECTIVE DECEMBER 1, 2021**

## Featured Models

### **GOOD :: \$887**

Enhanced synchro mechanism with Comfort Drive and seat-depth adjustment, fixed nylon arms, nylon base, grade 1 textile

### **BETTER :: \$927**

Enhanced synchro mechanism with Comfort Drive and seat-depth adjustment, multi-adjustable nylon arms, nylon base, grade 1 textile

### **BEST :: \$1,093**

Enhanced synchro mechanism with Comfort Drive and seat-depth adjustment, fixed polished aluminum arms, polished aluminum base, grade 1 textile

## Features

- Cutting-edge design
- Comfortable and durable mesh back
- 10 bleach-cleanable mesh colors
- Four frame/arm/back support color combinations
- Enhanced synchro with Comfort Drive and seat-depth adjustment
- Adjustable lumbar support
- Textured control knobs
- Waterfall seat

### 1. Back

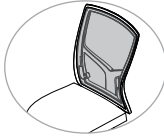
Back Size and Style	Code	Price	
Highback Mesh	6023	\$927	

### 2. Mechanism

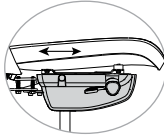
Mechanism	Code	Price	
Enhanced Synchro With Comfort Drive and Seat-Depth Adjustment	Y/E3	+\$0	

Seat-depth adjustment available with enhanced synchro (Y) mechanism only.

### 3. Frame

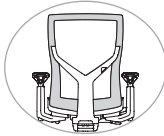
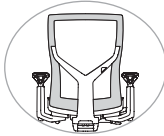

Frame Color	Code	Price	
Graphite	FC11	+\$0	
White	FC12	+\$0	

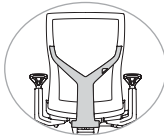
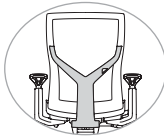
Back Support Color	Code	Price	
Graphite	Z3	+\$0	
White	Z4	+\$0	

## TASK CHAIR

### 4. Arms

Arm Style	Code	Price	
Armless	A0	-\$78	
Fixed Nylon	A132	-\$40	
Fixed Polished Aluminum	A131	+\$53	
Multi-Adjustable (Height/Width)	A134	+\$0	

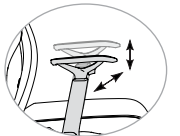
Arm color will match back support color. Fixed polished aluminum arms available with either back support color.

### 5. Base

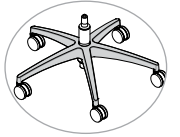
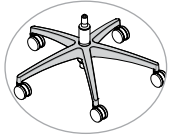
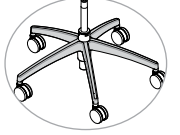
Base Color and Material	Code	Price	
Graphite Nylon Base (For Graphite Frame C11)	B14	+\$0	
White Nylon Base (For White Frame FC12)	B20	+\$0	
Polished Aluminum Base	B16	+\$113	

Nylon bases must pair with their corresponding frame color. Polished aluminum base (B16) can be used with either frame color.

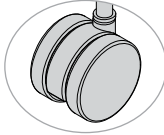
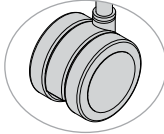
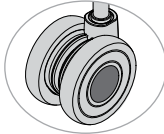
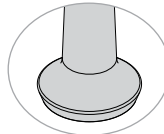

## 5. Base (Cont.)

Casters or Glides	Code	Price	
<b>Casters</b>			
Carpet Casters	C25	+ \$0	
Hard Floor and Carpet Casters	C26	+ \$40	
Designer Casters	C30	+ \$119	
<b>Glides</b>			
Glides for Task Chairs	C3	+ \$30	



## TASK CHAIR

### 5. Base (Cont.)

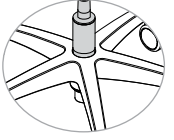
Cylinder Height	Code	Price	
Standard Cylinder	No Code	+ \$0	
Higher Cylinder	S13	+ \$0	

### 6. Material

Protection	Code	Price	
<b>Fire Retardancy</b>			
CAL 133, Fabric, Quantities 1-49	133F	+ \$99	
CAL 133, Fabric, Quantities 50+	133F5	+ \$55	
CAL 133, Leather, Any Quantity	133L	+ \$119	
<b>Mesh Color</b>			
Desert Solid Mesh	MC9	+ \$0	
Desert Striped Mesh	MC16	+ \$0	
Electric Blue Solid Mesh	MC13	+ \$0	
Fire Solid Mesh	MC10	+ \$0	
Fog Solid Mesh	MC7	+ \$0	
Fog Striped Mesh	MC15	+ \$0	
Navy Solid Mesh	MC8	+ \$0	
Nickel Solid Mesh	MC6	+ \$0	
Onyx Solid Mesh	MC5	+ \$0	
Onyx Striped Mesh	MC14	+ \$0	
<b>Seat Textile</b>			
Fabric/Vinyl Grade 1	FG1/VG1	+ \$0	
COM	COM	+ \$26	
Fabric/Vinyl Grade 2	FG2/VG2	+ \$26	
Fabric/Vinyl Grade 3	FG3/VG3	+ \$60	
Fabric/Vinyl Grade 4	FG4/VG4	+ \$116	
Fabric/Vinyl Grade 5	FG5/VG5	+ \$172	
Fabric/Vinyl Grade 6	FG6/VG6	+ \$213	
Fabric/Vinyl Grade 7	FG7/VG7	+ \$254	
Leather Grade 1	LG1	+ \$300	
COL	COL	+ \$380	
Leather Grade 2	LG2	+ \$380	
Leather Grade 3	LG3	+ \$480	

Please reference the Textile Reference Guide for pricing on fabric over grade 7 and leather over grade 3.

**7. Packaging**

Packaging	Code	Price
Knocked Down	KD	+ \$0
Back Attached to Seat, Base Separate	UC	+ \$80
Fully Assembled in a Carton	AC	+ \$200

**SPECIFICATIONS**

6023 Highback Mesh Task Chair	
<b>Dimensions</b>	
Overall Width Armless	26"
Overall Width With Arms	27"
Overall Depth	27.125"
Overall Height	44.5"
Seat Width	19"
Seat Depth	18"-20.25"
Seat Height	17.36"-21.75" 19"-23.75" (S13)
Back Width	19"
Back Height	22"
<b>Materials</b>	
COM	1 yd
COL	17 sq ft
<b>Weight and Capacity</b>	
Weight Armless	45 lb
Weight With Arms	50 lb
Weight Capacity Warranty	300 lb

*Higher cylinder (S13).*



# TR2

## TASK AND EXECUTIVE CHAIR

### *Ergonomics at work.*

Classic ergonomic design and lifetime durability make the TR2™ a reliable task, executive/conference chair. Six control and comfort mechanisms plus seven arm options mean this chair is more versatile and comfortable than any other chair in its price range.



*Best*

**EFFECTIVE DECEMBER 1, 2021**

### Featured Models

**GOOD :: \$760**

Midback task, swivel-tilt mechanism, height-adjustable arms, black nylon base, carpet casters, grade 1 textile

**BETTER :: \$886**

Midback task, multi-function mechanism, height-adjustable arms, black nylon base, carpet casters, grade 1 textile



**BEST :: \$975**



Midback task, enhanced synchro mechanism, height-/width-adjustable arms with pivot, seat-depth adjustment, black nylon base, carpet casters, grade 1 textile

## Features

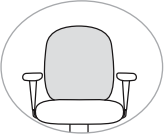
- Internal back-height adjustment
- Six control mechanisms for motion and comfort
- Optional seat-depth adjustment
- Waterfall seat promotes proper leg circulation
- Six arm styles
- Molded foam seat cushion
- CAL 133 approved models
- 300 lb weight capacity warranty;  
350 lb Heavy Duty 24/7 weight capacity warranty

### 1. Back

Back Size and Style	Code	Price	
Midback Task	40	\$886	
Highback Executive	40E	\$961	

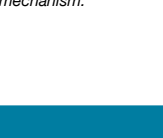
Back Options	Code	Price	
Upholstered Back	N	+ \$0	
Plastic Back for Task	E4	+ \$0	
Plastic Back for Executive	E5	+ \$0	

Plastic back (E4/E5) requires posture back (P) or multi-function (M) mechanism.

### 2. Heavy Duty

Heavy Duty Series	Code	Price	
Heavy Duty	HD	+ \$126	



Available with enhanced synchro (Y) or multi-function (M) mechanism only. See page 536 for additional LT and HD options.

## TASK CHAIR

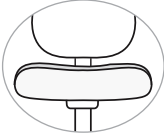
### 3. Seat

Seat Options	Code	Price	
1" Additional Foam	F1	+ \$36	

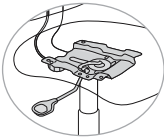

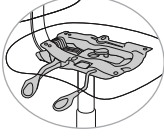
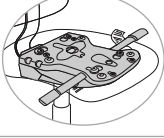
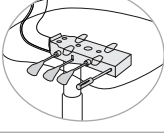
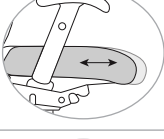
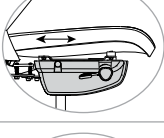
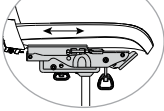
### 4. Mechanism

Mechanism	Code	Price	
Basic (Swivel Only)	B	- \$169	
Swivel-Tilt	T	- \$126	
Posture Back	P	- \$54	
Enhanced Synchro	Y	- \$36	
Multi-Function	M	+ \$0	
Posture Back With Seat-Depth Adjustment	P E3	+ \$25	
Enhanced Synchro Seat-Depth Adjustment	Y E3	+ \$43	
Multi-Function With Seat-Depth Adjustment	M E3	+ \$79	



**4. Mechanism (Cont.)**

Basic mechanism (B) not available on highback executive model (40E).

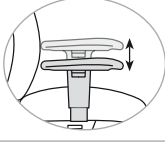
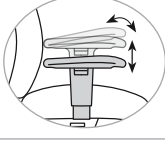
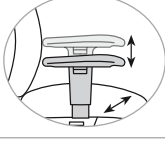
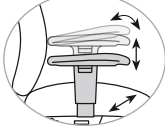
**5. Arms**

Arm Style	Code	Price	
Armless	A0	- \$110	
Fixed Pad	A12	- \$35	
Height-Adjustable	A15	+ \$0	
Height-Adjustable With Pivot	A43	+ \$10	
Height-/Width-Adjustable	A17	+ \$36	
Height-/Width-Adjustable With Pivot	A44	+ \$46	



**6. Base**

Base Color and Material	Code	Price	
Black Nylon Base	B0	+ \$0	
Heavy Duty Black Nylon Base, 26"	B7	+ \$0	

**TASK CHAIR**

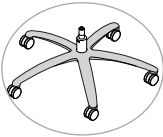
**6. Base (Cont.)**

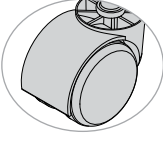
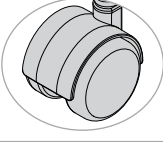
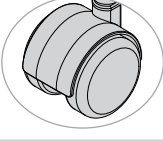
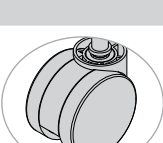
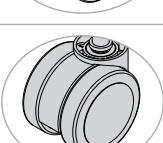
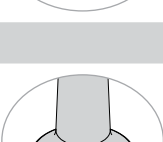
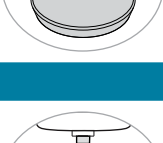
Brushed Aluminum Base	B2	+ \$113	
-----------------------	----	---------	---

Casters or Glides	Code	Price	
<b>Casters (For Black Base Only)</b>			
Carpet Casters	C5	+ \$0	
Hard Floor and Carpet Casters	C1	+ \$40	
Self-Locking Carpet Casters	C2	+ \$30	
Self-Locking Hard Floor and Carpet Casters	C7	+ \$61	
<b>Heavy Duty Casters</b>			
Heavy Duty Carpet Casters	C11	+ \$0	
Heavy Duty Hard Floor and Carpet Casters	C9	+ \$61	
<b>Glides</b>			
Glides for Task Chairs	C3	+ \$30	
<b>Cylinder Height</b>			
Cylinder Extension Kit	S3	+ \$89	

Glides (C3) are for black base only. Self-locking casters (C2/C7) lock only when chair is not in use.

Cylinder extension kit (S3) is only available with basic (B) or posture back (P) mechanisms.

## 7. Material

Protection	Code	Price	
<b>Fire Retardancy</b>			
CAL 133, Fabric, Quantities 1-49	133F	+ \$99	
CAL 133, Fabric, Quantities 50+	133F5	+ \$55	
Ballistic Nylon Back	Code	Price	
Ballistic Nylon Back	BN	+ \$0	
Seat and Back Textile	Code	Price	
Fabric/Vinyl Grade 1	FG1/VG1	+ \$0	
COM	COM	+ \$34	
Fabric/Vinyl Grade 2	FG2/VG2	+ \$34	
Fabric/Vinyl Grade 3	FG3/VG3	+ \$74	
Fabric/Vinyl Grade 4	FG4/VG4	+ \$121	
Fabric/Vinyl Grade 5	FG5/VG5	+ \$174	
Fabric/Vinyl Grade 6	FG6/VG6	+ \$235	
Fabric/Vinyl Grade 7	FG7/VG7	+ \$296	
Leather Grade 1	LG1	+ \$340	
COL	COL	+ \$460	
Leather Grade 2	LG2	+ \$460	
Leather Grade 3	LG3	+ \$600	

Please reference the *Textile Reference Guide* for pricing on fabric over grade 7 and leather over grade 3.

## 8. Packaging

Packaging	Code	Price	
Knocked Down	KD	+ \$0	
Back Attached to Seat, Base Separate	UC	+ \$80	
Fully Assembled in a Carton	AC	+ \$200	

## TASK CHAIR

### SPECIFICATIONS

	40 Midback Task	40E Highback Executive
<b>Dimensions</b>		
Overall Width	26"	26"
Overall Depth	26"	26"
Overall Height	36"	40.5"
Seat Width	20"	21"
Seat Depth	18"	20"
Seat Height	16.5"-21"	16.5"-21"
Back Width	18"	20"
Back Height	19.5"	24"
<b>Materials</b>		
COM	1.5 yd 1.25 yd (BN)	2 yd 1.7 yd (BN)
COL	25 sq ft 20 sq ft (BN)	36 sq ft 30 sq ft (BN)
<b>Weight and Capacity</b>		
Weight Armless	38 lb (B)	N/A (B)
	41 lb (T)	44 lb (T)
	42 lb (P)	45 lb (P)
	45 lb (Y)	45 lb (Y)
Weight With Arms	48 lb (M)	51 lb (M)
	43 lb (B)	N/A (B)
	46 lb (T)	49 lb (T)
	47 lb (P)	50 lb (P)
Weight Capacity Warranty	50 lb (Y)	50 lb (Y)
	47 lb (M)	56 lb (M)
Weight Capacity Warranty	300 lb	300 lb
	350 lb (Y/M) (HD)	350 lb (Y/M) (HD)

Basic mechanism (B). Swivel-tilt mechanism (T). Posture back mechanism (P). Enhanced synchro mechanism (Y). Multi-function mechanism (M). Ballistic nylon back (BN).

# TR2

## TASK STOOL

### *Ergonomics at work.*

The efficient, modest lines of the TR2 collection mimic the state of business: robust, reliable and not wasting a single step. Three control and comfort mechanisms plus six arm options create a multitude of customization opportunities that make this classic task stool more versatile and comfortable than any other in its price range.



**EFFECTIVE DECEMBER 1, 2021**

### Featured Models

#### **GOOD :: \$710**

Midback stool, basic mechanism, armless, standard stool kit, black nylon base, carpet casters, grade 1 textile

#### **BETTER :: \$935**

Midback stool, posture back mechanism, height-adjustable arms, standard stool kit, black nylon base, carpet casters, grade 1 textile

#### **BEST :: \$995**

Midback stool, posture back mechanism, height-/width-adjustable arms, extended stool kit, black nylon base, carpet casters, grade 1 textile

## Features

- Three control mechanisms for motion and comfort
- Waterfall seat
- Six arm styles
- Molded foam seat cushion
- 300 lb weight capacity warranty;  
350 lb Heavy Duty 24/7 weight capacity warranty

### 1. Back

Back Size and Style	Code	Price	
---------------------	------	-------	--

Midback Task

40

\$935

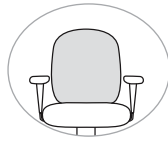

Back Options	Code	Price	
--------------	------	-------	--

Upholstered Back

N

+ \$0

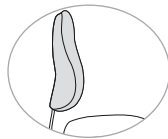

Plastic Back for Task

E4

+ \$0

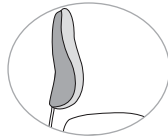

Plastic back (E4) requires posture back (P) mechanism.

### 2. Heavy Duty

Heavy Duty Series	Code	Price	
-------------------	------	-------	--

Heavy Duty

HD

+ \$191



Heavy Duty mechanism (HD) requires heavy duty stool kit (S1HD/S2HD).

### 3. Seat

Seat Options	Code	Price	
--------------	------	-------	--

1" Additional Foam

F1

+ \$36

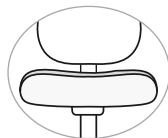

### 4. Mechanism

Mechanism Style	Code	Price	
-----------------	------	-------	--

Basic (Swivel Only)

B

- \$115

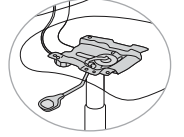

Posture Back

P

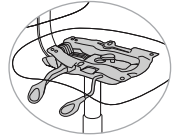

+ \$0





Good

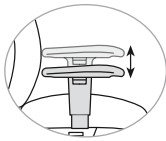
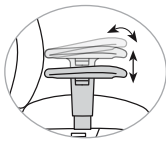
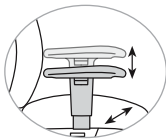
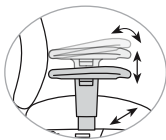

**5. Arms**

Arm Style	Code	Price	
Armless	A0	- \$110	
Fixed Pad	A12	- \$35	
Height-Adjustable	A15	+ \$0	
Height-Adjustable With Pivot	A43	+ \$10	
Height-/Width-Adjustable	A17	+ \$36	
Height-/Width-Adjustable With Pivot	A44	+ \$46	

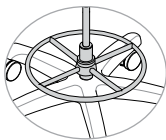
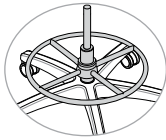
**6. Base**

Base	Code	Price	
Standard Stool Kit	S1	+ \$0	
Extended Stool Kit	S2	+ \$24	
Heavy Duty Stool Kit	S1HD	+ \$0	
Heavy Duty Extended Stool Kit	S2HD	+ \$24	

**TASK STOOL**

**6. Base (Cont.)**

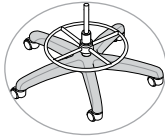
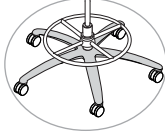
Base Color and Material	Code	Price	
Black Nylon Base	B0	+ \$0	
Brushed Aluminum Base	B2	+ \$113	

Casters or Glides	Code	Price	
<b>Casters (For Black Base Only)</b>			
Black Carpet Casters	C5	+ \$0	
Hard Floor and Carpet Casters	C1	+ \$40	
Self-Locking Carpet Casters	C2	+ \$30	
Self-Locking Hard Floor and Carpet Casters	C7	+ \$61	
<b>Heavy Duty Casters</b>			
Heavy Duty Carpet Casters	C11	+ \$0	
Heavy Duty Hard Floor and Carpet Casters	C9	+ \$61	
<b>Glides</b>			
Glides for Task Chairs	C3	+ \$30	

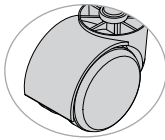
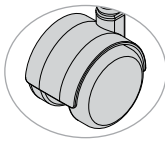
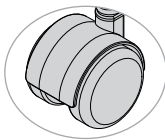
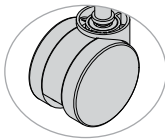
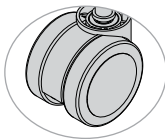
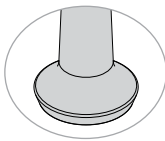
*Self-locking casters (C2/C7) lock only when chair is not in use.*

**7. Material**

Protection	Code	Price	
<b>Fire Retardancy</b>			
CAL 133, Fabric, Quantities 1–49	133F	+ \$99	
CAL 133, Fabric, Quantities 50+	133F5	+ \$55	
CAL 133, Leather, Any Quantity	133L	+ \$119	
Ballistic Nylon	Code	Price	
Ballistic Nylon Back	BN	+ \$0	
Seat and Back Textile	Code	Price	
Fabric/Vinyl Grade 1	FG1/VG1	+ \$0	
COM	COM	+ \$34	
Fabric/Vinyl Grade 2	FG2/VG2	+ \$34	
Fabric/Vinyl Grade 3	FG3/VG3	+ \$74	
Fabric/Vinyl Grade 4	FG4/VG4	+ \$121	
Fabric/Vinyl Grade 5	FG5/VG5	+ \$174	
Fabric/Vinyl Grade 6	FG6/VG6	+ \$235	
Fabric/Vinyl Grade 7	FG7/VG7	+ \$296	
Leather Grade 1	LG1	+ \$340	
COL	COL	+ \$460	
Leather Grade 2	LG2	+ \$460	
Leather Grade 3	LG3	+ \$600	

Please reference the *Textile Reference Guide* for pricing on fabric over grade 7 and leather over grade 3. Additional CAL 133 information can be found on page 10.

**8. Packaging**

Packaging	Code	Price	
Knocked Down	KD	+ \$0	
Back Attached to Seat, Base Separate	UC	+ \$80	
Fully Assembled in a Carton	AC	+ \$200	

**TASK STOOL****SPECIFICATIONS**

	40 S1 Task Stool	40 S2 Extended Task Stool
<b>Dimensions</b>		
Overall Width	27"	27"
Overall Depth	27"	27"
Overall Height	39"	43"
Seat Width	20"	20"
Seat Depth	19" 18" (HD)	18" 18" (HD)
Seat Height	19"–27" (B) 19.5"–27.5" (P)	23"–33" (B) 23.5"–33.5" (P)
Back Width	18"	18"
Back Height	21"	21"
<b>Materials</b>		
COM	1.5 yd 1.25 yd (BN)	1.5 yd 1.25 yd (BN)
COL	25 sq ft 20 sq ft (BN)	25 sq ft 20 sq ft (BN)
<b>Weight and Capacity</b>		
Weight Armless	42 lb (B) 45 lb (P) 43 lb (B2)(HD)	43 lb 43 lb (B2)(HD)
Weight With Arms	45 lb (B) 50 lb (P) 48 lb (B2) (HD)	48 lb 48 lb (B2) (HD)
Weight Capacity Warranty	300 lb 350 lb (HD)	300 lb 350 lb (HD)

Heavy Duty model (HD). Basic mechanism (B). Posture back mechanism (P). Heavy Duty mechanism (B2). Ballistic nylon back (BN).

# Vectra

## MESH BACK TASK CHAIR

### *Experience beyond.*

Meet our most advanced product yet. Vectra™ is next-gen intelligent design with smart features promising smarter solutions. It's a super-slim, precision-engineered package built to deliver robust on-demand comfort and the kind of cutting-edge innovation that redefines an entire category.



EFFECTIVE DECEMBER 1, 2021

### Featured Models

#### **GOOD :: \$790**

Highback mesh with enhanced synchro mechanism, adjustable lumbar, graphite frame, height-adjustable arms, graphite nylon base, carpet casters, grade 1 textile

#### **BETTER :: \$883**

Highback mesh with advanced synchro mechanism with seat-depth adjustment, adjustable lumbar, graphite frame, height-adjustable arms, graphite nylon base, carpet casters, grade 1 textile

#### **BEST :: \$978**

Highback mesh with advanced synchro mechanism with seat-depth adjustment, adjustable lumbar, fog frame, fully adjustable (8-way) arms, fog nylon base, carpet casters, grade 1 textile

## Features

- Activate proprietary lumbar tension and support with quick-adjust slide knobs
- Five tilt-limiter back positions for comfort in various activities
- Seat tension adjusts quickly in less than two revolutions
- Match performance casters and base to three different frame colors
- 6 colors of ultra-sheer micro mesh
- Customizable arm triggers, caster rings and lumbar adjustment carriage with 13 accent colors
- Energizing ergonomics from advanced synchro mechanism and cantilever arms
- Aerodynamic flair with low-profile arms and slim graphite arm pads

### 1. Back

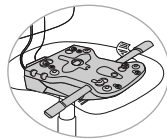
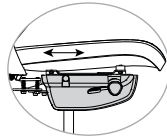
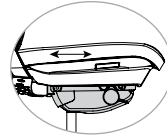

Back Size and Style	Code	Price	
Highback Mesh With Adjustable Lumbar Support	1073 BK2 MB	\$883	

### 2. Mechanism

Mechanism Style	Code	Price	
Enhanced Synchro	Y	- \$93	
Enhanced Synchro With Seat-Depth Adjustment	Y/E3	- \$54	
Advanced Synchro With Seat-Depth Adjustment	L/E3	+ \$0	

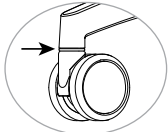

## MESH BACK TASK CHAIR

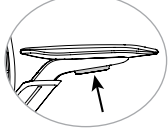
### 3. Frame

Frame Color	Code	Price	
Graphite	FC11	+\$0	
White	FC12	+\$35	
Fog	FC13	+\$35	
Accent Color	Code	Price	
Apple	LA12	+ \$0	
Desert	LA3	+ \$0	
Electric Blue	LA5	+ \$0	
Fire	LA6	+ \$0	
Fog	LA4	+ \$0	
Graphite	LA14	+ \$0	
Lemon	LA8	+ \$0	
Navy	LA15	+ \$0	
Nickel	LA2	+ \$0	
Onyx	LA1	+ \$0	
Platinum	LA16	+ \$0	
Tangerine	LA9	+ \$0	
White	LA13	+ \$0	

Accent color applies to lumbar adjustment, arm adjustment buttons and caster rings.

## 4. Arms

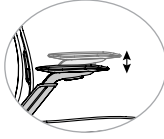
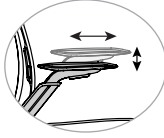
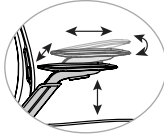
Arm Style	Code	Price	
Armless	AR0	- \$48	
Fixed Arms	AR2	- \$10	
Height-Adjustable	AR4	+ \$0	
Height-/Width-Adjustable	AR6	+ 30	
Fully Adjustable (8-Way)	AR9	+ \$60	

## 5. Base

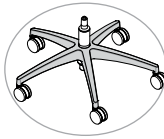
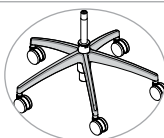
Base Color and Material	Code	Price	
Graphite Nylon Base (For Graphite Frame FC11)	B14	+ \$0	
Fog Nylon Base (For Fog Frame FC13)	B21	+ \$0	
White Nylon Base (For White Frame FC12)	B20	+ \$0	
Polished Aluminum Base	B18	+ \$113	

Nylon base color must match frame color. Aluminum base (B18) can be used with any frame color. Polished aluminum base (B18) is not available with lower cylinder (CH4).

## MESH BACK TASK CHAIR

## 5. Base (Cont.)

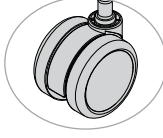
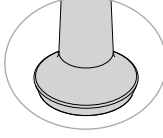
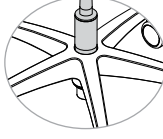
Casters or Glides	Code	Price	
<b>Casters</b>			
Carpet Casters	CS5	+ \$0	
Hard Floor and Carpet Casters	CS6	+ \$40	
<b>Glides</b>			
Glides for Task Chairs	CS3	+ \$30	
<b>Cylinder Height</b>			
Standard Cylinder	CH1	+ \$0	
Higher Cylinder	CH3	+ \$0	
Lower Cylinder	CH4	+ \$0	

Caster color coordinates with frame color. Lower cylinder (CH4) is not available with polished aluminum base (B18).

## 6. Material

Mesh Color	Code	Price	
Desert	MC9	+ \$0	
Mist	MC41	+ \$0	
Navy	MC8	+ \$0	
Nickel	MC6	+ \$0	
Onyx	MC5	+ \$0	
Platinum	MC42	+ \$0	
<b>Seat Textile</b>			
Fabric/Vinyl Grade 1	FG1/VG1	+ \$0	
COM	COM	+ \$26	
Fabric/Vinyl Grade 2	FG2/VG2	+ \$26	
Fabric/Vinyl Grade 3	FG3/VG3	+ \$60	
Fabric/Vinyl Grade 4	FG4/VG4	+ \$116	
Fabric/Vinyl Grade 5	FG5/VG5	+ \$172	
Fabric/Vinyl Grade 6	FG6/VG6	+ \$213	
Fabric/Vinyl Grade 7	FG7/VG7	+ \$254	
Leather Grade 1	LG1	+ \$300	
COL	COL	+ \$380	
Leather Grade 2	LG2	+ \$380	
Leather Grade 3	LG3	+ \$480	

Please reference the Textile Reference Guide for pricing on fabric over grade 7 and leather over grade 3.

### 7. Packaging

Packaging	Code	Price
Knocked Down	KD	+ \$0
Back Attached to Seat, Base Separate	UC	+ \$80
Fully Assembled in a Carton	AC	+ \$200

### SPECIFICATIONS

	1073.BK2.MB Highback Mesh Task Chair
<b>Dimensions</b>	
Overall Width Armless	26"
Overall Width With Arms	27"
Overall Depth	25"
Overall Height	38" (L/E3), 38.5" (Y/E3)
Seat Width	19.75"
Seat Depth	17"
Seat Height Short Cylinder	15.5"–17.63" (L/E3) 16"–18.1" (Y/E3)
Seat Height Standard Cylinder	16.5"–20.75" 17"–21.25" (Y/E3)
Seat Height High Cylinder	18.25"–22.63" (L/E3), 18.75"–23.1" (Y/E3)
Back Width	20.5"
Back Height	23"
<b>Materials</b>	
COM	1.1 yd
COL	20 sq ft
<b>Weight and Capacity</b>	
Weight Armless	30 lb
Weight With Arms	33 lb (L/E3), 41 lb (Y/E3)
Weight Capacity Warranty	300 lb

*Enhanced synchro with seat-depth Adjustment (Y/E3). Advanced synchro with seat-depth adjustment (L/E3)*



# Wit

## MESH BACK TASK CHAIR

### *Work smarter.*

Gone are the days where you clock in, stay in your cubicle and clock out. Dynamic environments call for adaptable seating that rolls with the punches. Our Wit™ family does exactly that. Because this is a design inspired by truths about how people work.

Today's ever-changing marketplace calls for flexibility. Teams need to be able to set up shop anywhere—and at any time. All of our Wit task models are easily adjustable so anyone can find a seat, settle in and get right to work.



**EFFECTIVE DECEMBER 1, 2021**

### Featured Models

#### **GOOD :: \$547**

Midback, swivel-tilt mechanism, height-adjustable arms, black frame, black nylon base, carpet casters, grade 1 textile

#### **BETTER :: \$593**

Highback, standard synchro mechanism, height-adjustable arms, black frame, black nylon base, carpet casters, grade 1 textile

#### **BEST :: \$747**

Highback, standard synchro mechanism with seat-depth adjustment, multi-adjustable arms, white frame and white nylon base, carpet casters, grade 1 textile

## Features

- Midback and highback task chairs
- Standard adjustable lumbar support
- Built-in pull handle
- 12 solid mesh back colors
- Four woven striped mesh options
- Three frame colors
- Standard synchro, swivel-tilt and basic mechanisms
- Multi-adjustable (height/width), height-adjustable, armless and fixed arms
- Textured designer arms
- Optional seat-depth adjustment
- Optional brushed aluminum base
- Waterfall seat
- Standard 300 lb weight capacity warranty
- Complemented by Wit Side; see page 267

### 1. Back

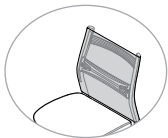
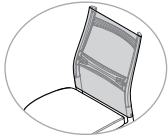
Back Size and Style	Code	Price	
Midback Mesh With Adjustable Lumbar Support	2222 B1	\$565	
Highback Mesh With Adjustable Lumbar Support	2223 B1	\$593	

### 2. Mechanism

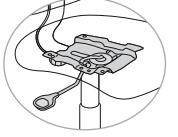
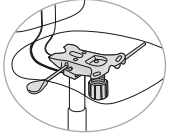
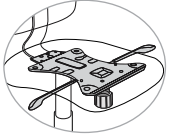
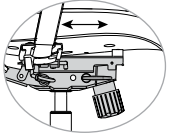

Mechanism	Code	Price	
Basic (Swivel Only)	B	- \$33	
Swivel-Tilt	T	- \$18	
Standard Synchro	F	+ \$0	
Standard Synchro With Seat-Depth Adjustment	F E3	+ \$79	

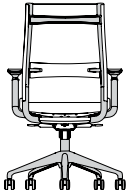
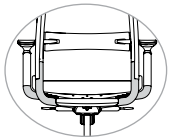
### 3. Frame

Frame Color	Code	Price	
Black	FC1	+ \$0	
White	FC12	+ \$45	
Fog	FC13	+ \$45	
Back Support Color	Code	Price	
Black (For Black Frame FC1)	Z1	+ \$0	
Silver (For Black Frame FC1)	Z2	+ \$0	
White (For White Frame FC12)	Z4	+ \$0	
Fog (For Fog Frame FC13)	Z7	+ \$0	



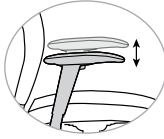
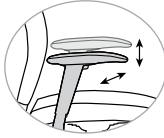

**4. Arms**

Arm Style	Code	Price	
Armless	A0	- \$48	
Fixed	A127	- \$10	
Height-Adjustable	A128	+ \$0	
Multi-Adjustable (Height/Width)	A129	+ \$30	

Arms, if specified, come with fog arm pads for the white and fog frames and black arm pads for the black frame.

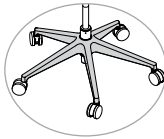
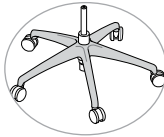
**5. Base**

Base Color and Material	Code	Price	
Black Nylon Base With Black Casters (For Black Frame FC1)	B0	+ \$0	
White Nylon Base With Fog/White Casters (For White Frame FC12)	B20	+ \$0	
Fog Nylon Base With Fog Casters (For Fog Frame FC13)	B21	+ \$0	
Brushed Aluminum Base	B8	+ \$113	
Heavy Duty Black Base, 26"	B7	+ \$0	

Heavy duty black base (B7) requires lower cylinder. Brushed aluminum base (B8) can be used with any frame color.

Chairs configured with the brushed aluminum base (B8) and standard synchro (F) mechanism ship with the High cylinder (S13)

**MESH BACK TASK CHAIR**

**5. Base (Cont.)**

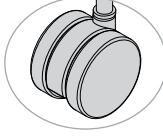
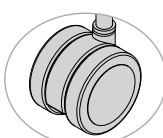
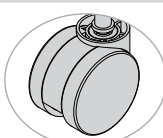
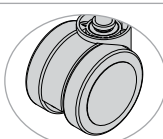
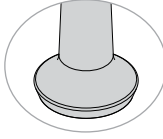
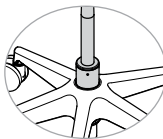
Casters or Glides	Code	Price	
<b>Casters</b>			
Black Carpet Casters (for Black Frame – FC1)	C16	+ \$0	
Black Hard Floor and Carpet Casters (For Black Frame FC1)	C17	+ \$40	
Hard Floor and Carpet Casters (For Fog or White Frame FC12/FC13)	CS6	+ \$0	
<b>Heavy Duty Casters</b>			
Heavy Duty Carpet Casters	C11	+ \$0	
Heavy Duty Hard Floor and Carpet Casters	C9	+ \$61	
<b>Glides</b>			
Glides for Task Chairs	C3	+ \$30	
<b>Cylinder Height</b>			
Standard Cylinder	S0	+ \$0	
Higher Cylinder	S13	+ \$0	
Lower Cylinder	S10	+ \$0	
Lower cylinder (S10) is available for Heavy Duty (HD) model only. Higher cylinder (S13) is required on chairs configured with the brushed aluminum base (B8) and standard synchro (F) mechanism.			
<b>6. Material</b>			
Protection	Code	Price	
<b>Fire Retardancy</b>			
CAL 133, Fabric, Quantities 1-49	133F	+ \$99	
CAL 133, Fabric, Quantities 50+	133F5	+ \$55	
CAL 133, Leather, Any Quantity	133L	+ \$119	

**6. Material (Cont.)**

Mesh Color	Code	Price	
<b>Solid Mesh</b>			
Apple	MC31	+ \$0	
Aqua	MC30	+ \$0	
Desert	MC22	+ \$0	
Electric Blue	MC24	+ \$0	
Fire	MC25	+ \$0	
Fog	MC23	+ \$0	
Grape	MC26	+ \$0	
Lemon	MC27	+ \$0	
Nickel	MC21	+ \$0	
Ocean	MC29	+ \$0	
Onyx	MC20	+ \$0	
Tangerine	MC28	+ \$0	
<b>Woven Striped Mesh</b>			
Fog	MC37	+ \$0	
Frost	MC36	+ \$0	
Nickel	MC38	+ \$0	
Onyx	MC35	+ \$0	
Seat Textile	Code	Price	
Fabric/Vinyl Grade 1	FG1/VG1	+ \$0	
COM	COM	+ \$26	
Fabric/Vinyl Grade 2	FG2/VG2	+ \$26	
Fabric/Vinyl Grade 3	FG3/VG3	+ \$60	
Fabric/Vinyl Grade 4	FG4/VG4	+ \$116	
Fabric/Vinyl Grade 5	FG5/VG5	+ \$172	
Fabric/Vinyl Grade 6	FG6/VG6	+ \$213	
Fabric/Vinyl Grade 7	FG7/VG7	+ \$254	
Leather Grade 1	LG1	+ \$300	
COL	COL	+ \$380	
Leather Grade 2	LG2	+ \$380	
Leather Grade 3	LG3	+ \$480	

Please reference the *Textile Reference Guide* for pricing on fabric over grade 7 and leather over grade 3. Additional CAL 133 information can be found on page 10.

**7. Packaging**

Packaging	Code	Price	
Knocked Down	KD	+ \$0	
Back Attached to Seat, Base Separate	UC	+ \$80	
Fully Assembled in a Carton	AC	+ \$200	

**MESH BACK TASK CHAIR****SPECIFICATIONS**

	2222 B1 Midback Mesh Task Chair	2223 B1 Highback Mesh Task Chair
<b>Dimensions</b>		
Overall Width Armless	25"	25"
Overall Width With Arms	26"	26"
Overall Depth	25"	25"
Overall Height	36.75"	40.75"
Seat Width	20"	20"
Seat Depth	17.5"-19.5"	17.5"-19.5"
Seat Height	17.5"-21.25" (F/T) 16.63"-20.38" (B) 17.75"-21.5" (F/E3)	17.5"-21.25" (F/T) 16.63"-20.38" (B) 17.75"-21.5" (F/E3)
Seat Height With Higher Cylinder	19"-22.5" (F/T) 18"-21.5" (B) 19"-22.5" (F/E3)	19"-22.5" (F/T) 18"-21.5" (B) 19"-22.5" (F/E3)
Seat Height With Lower Cylinder (B7)	15"-18" (B) 15.5"-18.5" (T) 15.63"-18.68" (F) 16"-19" (F/E3)	15"-18" (B) 15.5"-18.5" (T) 15.63"-18.68" (F) 16"-19" (F/E3)
Back Width	18.75"	18.75"
Back Height	19"	23"
<b>Materials</b>		
COM	1 yd	1 yd
COL	17 sq ft	17 sq ft
<b>Weight and Capacity</b>		
Weight Armless	30 lb	31 lb
Weight With Arms	36 lb	37 lb
Weight Capacity Warranty	300 lb	300 lb

*Basic mechanism (B). Swivel-tilt mechanism (T). Standard synchro mechanism (F).  
Seat-depth adjustment (E3).*

# Wit

## MESH BACK TASK STOOL

### *Work smarter.*

Gone are the days where you clock in, stay in your cubicle and clock out. Dynamic environments call for adaptable seating that rolls with the punches. Our Wit™ family does exactly that. Because this is a design inspired by truths about how people work.

Today's ever-changing marketplace calls for flexibility. Teams need to be able to set up shop anywhere—and at any time. All of our Wit task models are easily adjustable so anyone can find a seat, settle in and get right to work.



*Best*

**EFFECTIVE DECEMBER 1, 2021**

### Featured Models

#### **GOOD :: \$594**

Midback mesh with adjustable lumbar, basic mechanism, armless, black frame, standard stool kit, carpet casters, grade 1 textile

#### **BETTER :: \$642**

Midback mesh with adjustable lumbar, basic mechanism, height-adjustable arms, black frame, standard stool kit, carpet casters, grade 1 textile

#### **BEST :: \$741**

Midback mesh with adjustable lumbar, basic mechanism, multi-adjustable arms, fog frame, extended stool kit, carpet casters, grade 1 textile

MESH BACK TASK STOOL

Features

- Midback task stool
- Standard adjustable lumbar support
- Built-in pull handle
- 12 solid mesh back colors
- Four woven striped mesh options
- Three frame colors
- Basic mechanism
- Multi-adjustable (height/width), height-adjustable, armless and fixed arms
- Textured designer arms
- Optional brushed aluminum base
- Waterfall seat
- Standard 300 lb weight capacity warranty
- Complemented by Wit Side; see page 267

1. Back

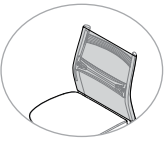
Back Size and Style	Code	Price	
Midback Mesh With Adjustable Lumbar Support	2222 B1	\$642	

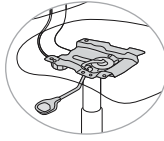

2. Mechanism

Mechanism	Code	Price	
Basic (Swivel Only)	B	+ \$0	

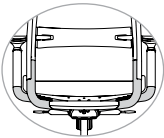
3. Frame

Frame Color	Code	Price	
Black	FC1	+ \$0	
White	FC12	+ \$45	
Fog	FC13	+ \$45	
Back Support Color	Code	Price	
Black (For Black Frame FC1)	Z1	+ \$0	
Silver (For Black Frame FC1)	Z2	+ \$0	
White (For White Frame FC12)	Z4	+ \$0	
Fog (For Fog Frame FC13)	Z7	+ \$0	

4. Arms

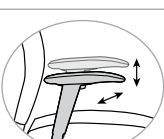
Arm Style	Code	Price	
Armless	A0	- \$48	
Fixed	A127	- \$10	
Height-Adjustable	A128	+ \$0	
Multi-Adjustable (Height/Width)	A129	+ \$30	

Arms, if specified, come with fog arm pads for the white and fog frames and black arm pads for the black frame.

**5. Base**

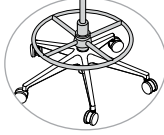
Base	Code	Price	
Stool Kit	S1	+ \$0	
Extended Stool Kit	S2	+ \$24	

Base Color and Material	Code	Price	
Black Nylon Base With Black Casters (For Black Frame FC1)	B0	+ \$0	
White Nylon Base With Fog/White Casters (For White Frame FC12)	B20	+ \$0	
Fog Nylon Base With Fog Casters (For Fog Frame FC13)	B21	+ \$0	

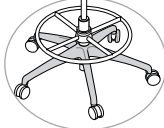
Brushed Aluminum Base	B8	+ \$113	
-----------------------	----	---------	---

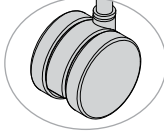
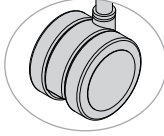
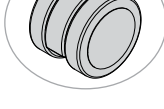
Castors or Glides	Code	Price	
<b>Castors</b>			
Black Carpet Casters (For Black Frame FC1)	C16	+ \$0	
Black Hard Floor and Carpet Casters (For Black Frame FC1)	C17	+ \$40	
Hard Floor and Carpet Casters (For Fog or White Frame FC12/FC13)	CS6	+ \$0	

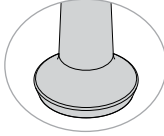
<b>Glides</b>			
Glides for Task Chairs	C3	+ \$30	

Brushed aluminum base (B8) can be used with any frame color.

**MESH BACK TASK STOOL**

**6. Material**

Protection	Code	Price	
<b>Fire Retardancy</b>			
CAL 133, Fabric, Quantities 1-49	133F	+ \$99	
CAL 133, Fabric, Quantities 50+	133F5	+ \$55	
CAL 133, Leather, Any Quantity	133L	+ \$119	

Mesh Color	Code	Price	
<b>Solid Mesh</b>			
Apple	MC31	+ \$0	
Aqua	MC30	+ \$0	
Desert	MC22	+ \$0	
Electric Blue	MC24	+ \$0	
Fire	MC25	+ \$0	
Fog	MC23	+ \$0	
Grape	MC26	+ \$0	
Lemon	MC27	+ \$0	
Nickel	MC21	+ \$0	
Ocean	MC29	+ \$0	
Onyx	MC20	+ \$0	
Tangerine	MC28	+ \$0	

<b>Woven Striped Mesh</b>			
Fog	MC37	+ \$0	
Frost	MC36	+ \$0	
Nickel	MC38	+ \$0	
Onyx	MC35	+ \$0	

Seat Textile	Code	Price	
Fabric/Vinyl Grade 1	FG1/VG1	+ \$0	
COM	COM	+ \$26	
Fabric/Vinyl Grade 2	FG2/VG2	+ \$26	
Fabric/Vinyl Grade 3	FG3/VG3	+ \$60	
Fabric/Vinyl Grade 4	FG4/VG4	+ \$116	
Fabric/Vinyl Grade 5	FG5/VG5	+ \$172	
Fabric/Vinyl Grade 6	FG6/VG6	+ \$213	
Fabric/Vinyl Grade 7	FG7/VG7	+ \$254	
Leather Grade 1	LG1	+ \$300	
COL	COL	+ \$380	
Leather Grade 2	LG2	+ \$380	
Leather Grade 3	LG3	+ \$480	

Please reference the *Textile Reference Guide* for pricing on fabric over grade 7 and leather over grade 3. Additional CAL 133 information can be found on page 10.

**7. Packaging**

Packaging	Code	Price
Knocked Down	KD	+ \$0
Back Attached to Seat, Base Separate	UC	+ \$80
Fully Assembled in a Carton	AC	+ \$200

**SPECIFICATIONS**

	2222 B1 S1 Midback Mesh Task Stool	2222 B1 S2 Midback Mesh Extended Task Stool
<b>Dimensions</b>		
Overall Width	27"	27"
Overall Depth	27"	27"
Overall Height	45.63"	50"
Seat Width	20"	20"
Seat Depth	17.5"	17.5"
Seat Height	22"- 30"	26"-36"
Back Width	19"	19"
Back Height	18.75"	18.75"
<b>Materials</b>		
COM	1 yd	1 yd
COL	17 sq ft	17 sq ft
<b>Weight and Capacity</b>		
Weight Armless	28.5 lb	29.5 lb
Weight With Arms	34.5 lb	35.5 lb
Weight Capacity Warranty	300 lb	300 lb

# Wit

## THINTEX BACK TASK CHAIR

### *Work smarter.*

Gone are the days where you clock in, stay in your cubicle and clock out. Dynamic environments call for adaptable seating that rolls with the punches. Our Wit™ family does exactly that. Because this is a design inspired by truths about how people work.

Today's ever-changing marketplace calls for flexibility. Teams need to be able to set up shop anywhere—and at any time. All of our Wit task models are easily adjustable so anyone can find a seat, settle in and get right to work.



**EFFECTIVE DECEMBER 1, 2021**

### Featured Models

#### **GOOD :: \$613**

Midback, swivel-tilt mechanism, height-adjustable arms, black frame, black nylon base, carpet casters, grade 1 textile

#### **BETTER :: \$659**

Highback, standard synchro mechanism, height-adjustable arms, black frame, black nylon base, carpet casters, grade 1 textile

#### **BEST :: \$813**

Highback, standard synchro mechanism, seat-depth adjustment, multi-adjustable (height/width) arms, white frame, white nylon base, carpet casters, grade 1 textile

## Features

- Midback and highback task chairs
- Standard adjustable lumbar support
- Built-in pull handle
- 12 Thintex back colors in fabric or vinyl
- Three frame colors
- Standard synchro, swivel-tilt and basic mechanisms
- Multi-adjustable (height/width), height-adjustable, armless and fixed arms
- Textured designer arms
- Optional seat-depth adjustment
- Optional brushed aluminum base
- Waterfall seat
- Standard 300 lb weight capacity warranty
- Complemented by Wit Side; see page 270

### 1. Back

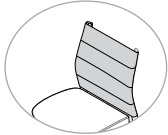
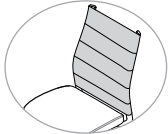
Back Size and Style	Code	Price	
Thintex Midback With Adjustable Lumbar Support	2222 B9	\$631	
Thintex Highback With Adjustable Lumbar Support	2223 B9	\$659	
Back Material	Code	Price	
Fabric	TX1	+ \$0	
Vinyl	TX2	+ \$0	

### 2. Mechanism

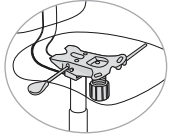
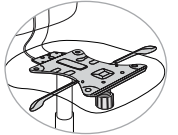
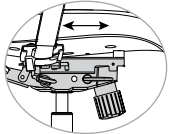

Mechanism Style	Code	Price	
Basic (Swivel Only)	B	- \$33	
Swivel-Tilt	T	- \$18	
Standard Synchro	F	+ \$0	
Standard Synchro With Seat-Depth Adjustment	F E3	+ \$79	

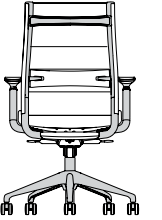
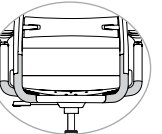
### 3. Frame

Frame Color	Code	Price	
Black	FC1	+ \$0	
White	FC12	+ \$45	
Fog	FC13	+ \$45	
Back Support Color	Code	Price	
Black (For Black Frame FC1)	Z1	+ \$0	
Silver (For Black Frame FC1)	Z2	+ \$0	
White (For White Frame FC12)	Z4	+ \$0	
Fog (For Fog Frame FC13)	Z7	+ \$0	

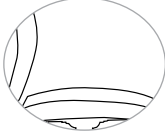

**4. Arms**

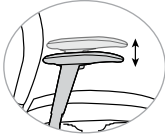
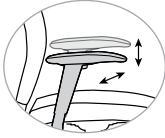
Arm Style	Code	Price	
Armless	A0	- \$48	
Fixed	A127	- \$10	
Height-Adjustable	A128	+ \$0	
Multi-Adjustable (Height/Width)	A129	+ \$30	

Arms, if specified, come with fog arm pads for the white and fog frames and black arm pads for the black frame.

**5. Base**

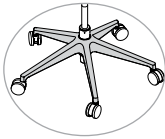
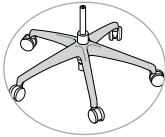
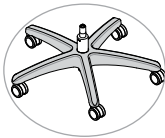
Base Color and Material	Code	Price	
Black Nylon Base With Black Casters (For Black Frame FC1)	B0	+ \$0	
White Nylon Base With Fog/White Casters (For White Frame FC12)	B20	+ \$0	
Fog Nylon Base With Fog Casters (For Fog Frame FC13)	B21	+ \$0	
Brushed Aluminum Base	B8	+ \$113	
Heavy Duty Black Base, 26"	B7	+ \$0	

Heavy duty black base (B7) requires lower cylinder. Brushed aluminum base (B8) can be used with any frame color.

Chairs configured with the brushed aluminum base (B8) and standard synchro (F) mechanism ship with the High cylinder (S13)

**THINTEX BACK TASK CHAIR**

**5. Base**

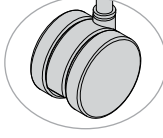
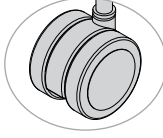
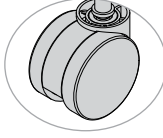
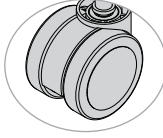
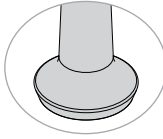
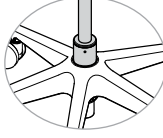
Casters or Glides	Code	Price	
<b>Casters</b>			
Black Carpet Casters (For Black Frame FC1)	C16	+ \$0	
Black Hard Floor and Carpet Casters (For Black Frame FC1)	C17	+ \$40	
Hard Floor and Carpet Casters (For Fog or White Frame FC12/FC13)	CS6	+ \$0	
<b>Heavy Duty Casters</b>			
Heavy Duty Carpet Casters	C11	+ \$0	
Heavy Duty Hard Floor and Carpet Casters	C9	+ \$61	
<b>Glides</b>			
Glides for Task Chairs	C3	+ \$30	
<b>Cylinder Height</b>			
Standard Cylinder	S0	+ \$0	
Higher Cylinder	S13	+ \$0	
Lower Cylinder	S10	+ \$0	
Lower cylinder (S10) is available for Heavy Duty (HD) model only. Higher cylinder (S13) is required on chairs configured with the brushed aluminum base (B8) and standard synchro (F) mechanism.			
<b>6. Material</b>			
Protection	Code	Price	
<b>Fire Retardancy</b>			
CAL 133, Fabric, Quantities 1-49	133F	+ \$99	
CAL 133, Fabric, Quantities 50+	133F5	+ \$55	
CAL 133, Leather, Any Quantity	133L	+ \$119	

**6. Material (Cont.)**

Thintex Color	Code	Price	
Apple	MC31	+ \$0	
Aqua	MC30	+ \$0	
Desert	MC22	+ \$0	
Electric Blue	MC24	+ \$0	
Fire	MC25	+ \$0	
Fog	MC23	+ \$0	
Grape	MC26	+ \$0	
Lemon	MC27	+ \$0	
Nickel	MC21	+ \$0	
Ocean	MC29	+ \$0	
Onyx	MC20	+ \$0	
Tangerine	MC28	+ \$0	
Tangerine	MC28	+ \$0	
Seat Textile	Code	Price	
Fabric/Vinyl Grade 1	FG1/VG1	+ \$0	
COM	COM	+ \$26	
Fabric/Vinyl Grade 2	FG2/VG2	+ \$26	
Fabric/Vinyl Grade 3	FG3/VG3	+ \$60	
Fabric/Vinyl Grade 4	FG4/VG4	+ \$116	
Fabric/Vinyl Grade 5	FG5/VG5	+ \$172	
Fabric/Vinyl Grade 6	FG6/VG6	+ \$213	
Fabric/Vinyl Grade 7	FG7/VG7	+ \$254	
Leather Grade 1	LG1	+ \$300	
COL	COL	+ \$380	
Leather Grade 2	LG2	+ \$380	
Leather Grade 3	LG3	+ \$480	

Please reference the *Textile Reference Guide* for pricing on fabric over grade 7 and leather over grade 3. Additional CAL 133 information can be found on page 10.

**7. Packaging**

Packaging	Code	Price	
Knocked Down	KD	+ \$0	
Back Attached to Seat, Base Separate	UC	+ \$80	
Fully Assembled in a Carton	AC	+ \$200	

**THINTEX BACK TASK CHAIR****SPECIFICATIONS**

	2222 B9 Midback Thintex Task Chair	2223 B9 Highback Thintex Task Chair
<b>Dimensions</b>		
Overall Width	26"	26"
Overall Depth	26"	26"
Overall Height	36.75"	40.75"
Seat Width	20"	20"
Seat Depth	17.5"-19.5"	17.5"-19.5"
Seat Height	17.5"-21.25" (F/T) 16.63"-20.38" (B) 17.75"-21.5" (F/E3)	17.5"-21.25" (F/T) 16.63"-20.38" (B) 17.75"-21.5" (F/E3)
Seat Height With Higher Cylinder	19"-22.5" (F/T) 18"-21.5" (B) 19"-22.5" (F/E3)	19"-22.5" (F/T) 18"-21.5" (B) 19"-22.5" (F/E3)
Seat Height With Lower Cylinder (B7)	15.63"-18.68" (F) 15.5"-18.5" (T) 15"-18" (B) 16"-19" (F/E3)	15.63"-18.68" (F) 15.5"-18.5" (T) 15"-18" (B) 16"-19" (F/E3)
Back Width	18.75"	18.75"
Back Height	19"	23"
<b>Materials</b>		
COM	1 yd	1 yd
COL	17 sq ft	17 sq ft
<b>Weight and Capacity</b>		
Weight Armless	30 lb	31 lb
Weight With Arms	36 lb	37 lb
Weight Capacity Warranty	300 lb	300 lb

Basic mechanism (B). Swivel-tilt mechanism (T). Standard synchro mechanism (F).  
Seat-depth adjustment (E3).

# Wit

## THINTEX BACK TASK STOOL

### *Work smarter.*

Gone are the days where you clock in, stay in your cubicle and clock out. Dynamic environments call for adaptable seating that rolls with the punches. Our Wit™ family does exactly that. Because this is a design inspired by truths about how people work.

Today's ever-changing marketplace calls for flexibility. Teams need to be able to set up shop anywhere—and at any time. All of our Wit task models are easily adjustable so anyone can find a seat, settle in and get right to work.



**EFFECTIVE DECEMBER 1, 2021**

### Featured Models

#### **GOOD :: \$660**

Midback task stool with adjustable lumbar, basic mechanism, armless, black frame, standard stool kit, black nylon base, carpet casters, grade 1 textile

#### **BETTER :: \$708**

Midback task stool with adjustable lumbar, basic mechanism, height-adjustable arms, black frame, standard stool kit, black nylon base, carpet casters, grade 1 textile

#### **BEST :: \$777**

Midback task stool with adjustable lumbar, basic mechanism, height-adjustable arms, fog frame, extended stool kit, fog nylon base, carpet casters, grade 1 textile

## Features

- Midback task stool
- Standard adjustable lumbar support
- Built-in pull handle
- 12 Thintex back colors in fabric or vinyl
- Three frame colors
- Basic mechanism
- Multi-adjustable (height/width), height-adjustable, armless and fixed arms
- Textured designer arms
- Optional brushed aluminum base
- Waterfall seat
- Standard 300 lb weight capacity warranty
- Complemented by Wit Side; see page 270

### 1. Back

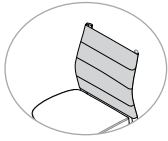
Back Size and Style	Code	Price	
Midback Thintex With Adjustable Lumbar Support	2222 B9	\$708	
Back Material	Code	Price	
Fabric	TX1	+ \$0	
Vinyl	TX2	+ \$0	

### 2. Mechanism

Mechanism	Code	Price	
Basic (Swivel Only)	B	+ \$0	

### 3. Frame

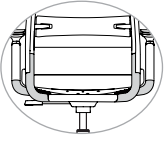
Frame Color	Code	Price	
Black	FC1	+ \$0	
White	FC12	+ \$45	
Fog	FC13	+ \$45	
Back Support Color	Code	Price	
Black (For Black Frame FC1)	Z1	+ \$0	
Silver (For Black Frame FC1)	Z2	+ \$0	
White (For White Frame FC12)	Z4	+ \$0	
Fog (For Fog Frame FC13)	Z7	+ \$0	

### 4. Arms

Arm Style	Code	Price	
Armless	A0	- \$48	
Fixed	A127	- \$10	
Height-Adjustable	A128	+ \$0	
Multi-Adjustable (Height/Width)	A129	+ \$30	

Arms, if specified, come with fog arm pads for the white and fog frames and black arm pads for the black frame.

5. Base

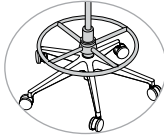
Base	Code	Price	
Stool Kit	S1	+ \$0	
Extended Stool Kit	S2	+ \$24	

Base Color and Material	Code	Price	
Black Nylon Base With Black Casters (For Black Frame FC1)	B0	+ \$0	
White Nylon Base With Fog/White Casters (For White Frame FC12)	B20	+ \$0	
Fog Nylon Base With Fog Casters (For Fog Frame FC13)	B21	+ \$0	

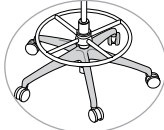
Brushed Aluminum Base	B8	+ \$113	
-----------------------	----	---------	---

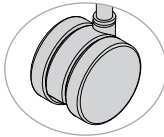
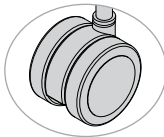
Casters or Glides	Code	Price	
<b>Casters</b>			
Black Carpet Casters (For Black Frame FC1)	C16	+ \$0	
Black Hard Floor and Carpet Casters (For Black Frame FC1)	C17	+ \$40	
Hard Floor and Carpet Casters (For Fog or White Frame FC12/FC13)	CS6	+ \$0	

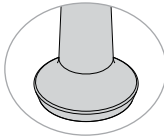
<b>Glides</b>			
Glides for Task Chairs	C3	+ \$30	

Brushed aluminum base (B8) can be used with any frame color.

THINTEX BACK TASK STOOL

6. Material

Protection	Code	Price	
<b>Fire Retardancy</b>			
CAL 133, Fabric, Quantities 1-49	133F	+ \$99	
CAL 133, Fabric, Quantities 50+	133F5	+ \$55	
CAL 133, Leather, Any Quantity	133L	+ \$119	

Thintex Color	Code	Price	
Apple	MC31	+ \$0	
Aqua	MC30	+ \$0	
Desert	MC22	+ \$0	
Electric Blue	MC24	+ \$0	
Fire	MC25	+ \$0	
Fog	MC23	+ \$0	
Grape	MC26	+ \$0	
Lemon	MC27	+ \$0	
Nickel	MC21	+ \$0	
Ocean	MC29	+ \$0	
Onyx	MC20	+ \$0	
Tangerine	MC28	+ \$0	

Seat Textile	Code	Price	
Fabric/Vinyl Grade 1	FG1/VG1	+ \$0	
COM	COM	+ \$26	
Fabric/Vinyl Grade 2	FG2/VG2	+ \$26	
Fabric/Vinyl Grade 3	FG3/VG3	+ \$60	
Fabric/Vinyl Grade 4	FG4/VG4	+ \$116	
Fabric/Vinyl Grade 5	FG5/VG5	+ \$172	
Fabric/Vinyl Grade 6	FG6/VG6	+ \$213	
Fabric/Vinyl Grade 7	FG7/VG7	+ \$254	
Leather Grade 1	LG1	+ \$300	
COL	COL	+ \$380	
Leather Grade 2	LG2	+ \$380	
Leather Grade 3	LG3	+ \$480	

Please reference the Textile Reference Guide for pricing on fabric over grade 7 and leather over grade 3. Additional CAL 133 information can be found on page 10.

**7. Packaging**

Packaging	Code	Price
Knocked Down	KD	+ \$0
Back Attached to Seat, Base Separate	UC	+ \$80
Fully Assembled in a Carton	AC	+ \$200

**SPECIFICATIONS**

	2222 B9 S1 Midback Thintex Task Stool	2222 B9 S2 Midback Thintex Extended Task Stool
<b>Dimensions</b>		
Overall Width	27"	27"
Overall Depth	27"	27"
Overall Height	8.5" (B0/B20/B21) 36.5" (B8)	43" (B0/B20/B21) 41" (B8)
Seat Width	20"	20"
Seat Depth	17.5"	17.5"
Seat Height	22"-30"	26"-36"
Back Width	19"	19"
Back Height	18.75"	18.75"
Weight Armless	28.5 lb	29.5 lb
Weight With Arms	34.5 lb	35.5 lb
<b>Materials</b>		
COM	1 yd	1 yd
COL	17 sq ft	17 sq ft
<b>Weight and Capacity</b>		
Weight Capacity Warranty	300 lb	300 lb

*Black base (B0). White base (B20). Fog base (B21). Brushed aluminum base (B8).*

# Chairs and Stools

MULTIPURPOSE | SIDE | GUEST | BARIATRIC  
COUNTER STOOL | BAR STOOL

# Statement of Line

MULTIPURPOSE | SIDE | GUEST | BARIATRIC  
COUNTER STOOL | BAR STOOL

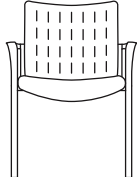

**Achieve**  
4-Leg Multipurpose Chair  
91 US..... 198

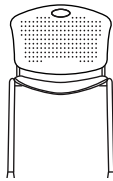

**Anytime**  
4-Leg Multipurpose Chair  
93..... 201

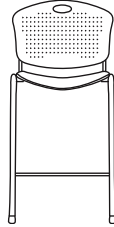

**Anytime**  
4-Leg Bar Stool  
93 S2 ..... 201



**Baja**  
Wire Rod Multipurpose Chair  
1171 FT2 BK4..... 205

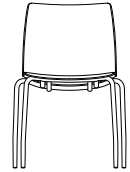

**Baja**  
4-Leg Multipurpose Chair  
1171 FT1 BK4..... 205



**Baja**  
Wire Bar Stool  
1171 FT2 S2 BK4..... 205

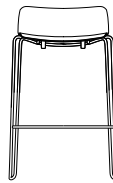

**Baja**  
Low Back Wire Rod Bar  
1171 FT2 S2 BK3..... 205

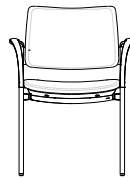

**Cora**  
Guest Chair  
5651/5652 ..... 210

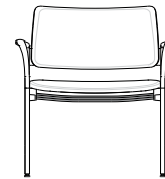

**Cora**  
Midsized Chair  
5651/5652 ..... 210

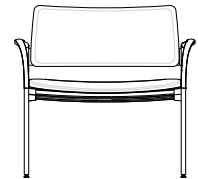

**Cora**  
Bariatric Chair  
5651/5652 ..... 210

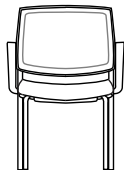

**Focus Side Mesh**  
4-Leg Side Chair  
5651/5652 ..... 215

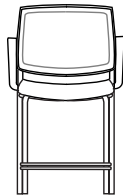

**Focus Side Mesh**  
4-Leg Counter Stool  
5651/5652 S9 ..... 215

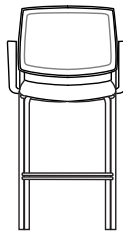

**Focus Side Mesh**  
4-Leg Bar Stool  
5651/5652 S2 ..... 215

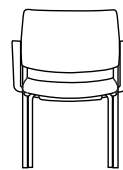

**Focus Side Upholstered**  
4-Leg Side Chair  
5651/5652 ..... 215

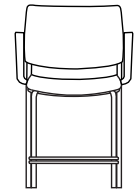

**Focus Side Upholstered**  
4-Leg Counter Stool  
5651/5652 S9 ..... 215

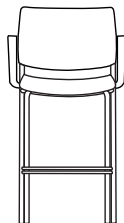

**Focus Side Upholstered**  
4-Leg Bar Stool  
5651/5652 S2 ..... 215

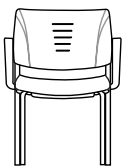

**Focus Side Wood**  
4-Leg Side Chair  
5651/5652 ..... 215

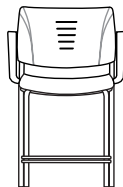

**Focus Side Wood**  
4-Leg Counter Stool  
5651/5652 S9 ..... 215

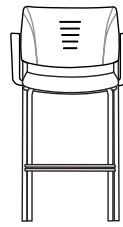

**Focus Side Wood**  
4-Leg Bar Stool  
5651/5652 S2 ..... 215

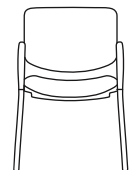

**Freelance**  
Wire Rod Multipurpose Chair  
523X ..... 220



# Statement of Line

MULTIPURPOSE | SIDE | GUEST | BARIATRIC  
COUNTER STOOL | BAR STOOL

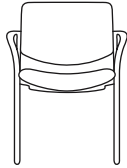

**Freelance**  
4-Leg Multipurpose Chair  
521X ..... 220

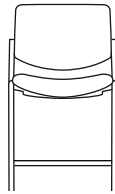

**Freelance**  
4-Leg Counter Stool  
5214 S9 ..... 220

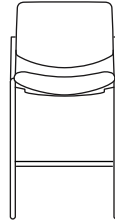

**Freelance**  
4-Leg Bar Stool  
5214 S2 ..... 220

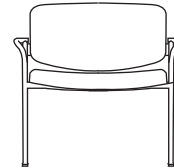

**Freelance**  
30" Bariatric Chair  
5314 ..... 226

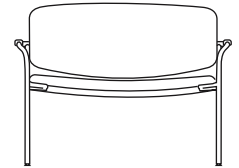

**Freelance**  
42" Bariatric Chair  
5414 ..... 226

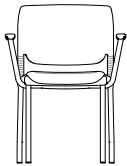

**InFlex**  
4-Leg Multipurpose Chair  
971 ..... 229

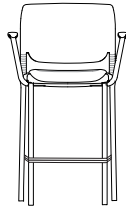

**InFlex**  
4-Leg Counter Stool  
971 S9 ..... 229

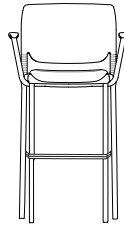

**InFlex**  
4-Leg Bar Stool  
971 S2 ..... 229

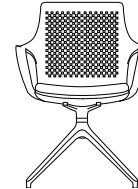

**Ioniq**  
4-Star Guest Chair  
1152 FT5 ..... 233

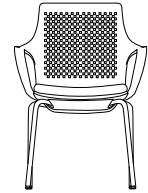

**Ioniq**  
4-Leg Multipurpose Chair  
1151 FT1 ..... 235

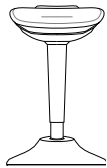

**Kickstand**  
Stool  
1167 ..... 237

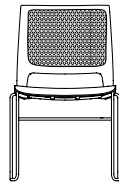

**Lumin**  
Wire Rod Multipurpose Chair  
1011 FT2 ..... 239

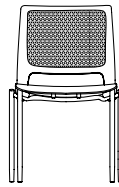

**Lumin**  
4-Leg Multipurpose Chair  
1011 FT1 ..... 239

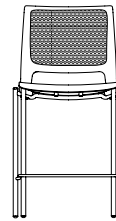

**Lumin**  
4-Leg Counter Stool  
1011 FT1 S9 ..... 239

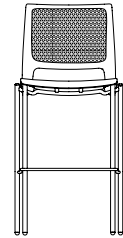

**Lumin**  
4-Leg Bar Stool  
1011 FT1 S2 ..... 239

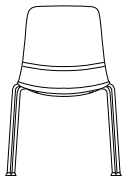

**Mika**  
4-Leg Multipurpose Chair  
1101 FT1 S9 ..... 244

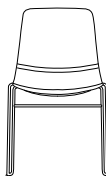

**Mika**  
Wire Rod Multipurpose Chair  
1101 FT1 S9 ..... 244

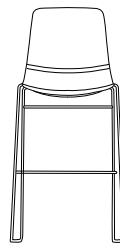

**Mika**  
Wire Rod Bar Stool  
1101 FT1 S9 ..... 244



**Movi**  
Nester Chair  
1061 FT4 ..... 247

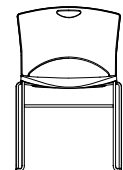

**OnCall**  
Wire Rod Multipurpose Chair  
90 ..... 250

# Statement of Line

MULTIPURPOSE | SIDE | GUEST | BARIATRIC  
COUNTER STOOL | BAR STOOL

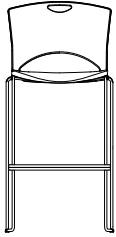

**OnCall**  
Wire Rod Bar Stool  
90 S2 .....250

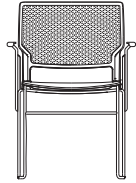

**Orbix**  
Wire Rod Chair  
1131 FT2 .....254

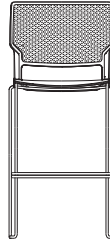

**Orbix**  
Wire Rod Bar Stool  
1131 FT2 S2 .....254

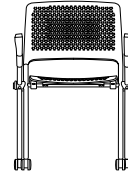

**Qwiz**  
Nester Chair  
1141 FT4.....258

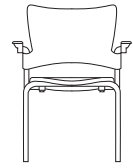

**Relay**  
Multipurpose Chair  
94S .....262

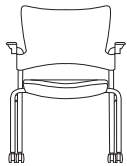

**Relay**  
Nester Chair  
94XB/94XS.....265

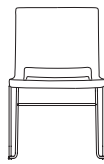

**Rio**  
Wire Rod Multipurpose Chair  
1051 FT2.....268

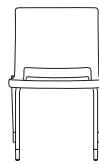

**Rio**  
4-Leg Multipurpose Chair  
1051 FT1.....268

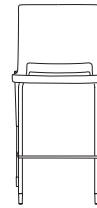

**Rio**  
4-Leg Counter Stool  
1051 FT1 S9 .....268

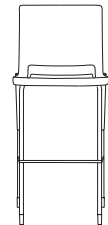

**Rio**  
4-Leg Bar Stool  
1051 FT1 S2 .....268

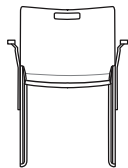

**Rowdy**  
4-Leg Bar Stool  
92 SB/92 SC .....272



**Sprout**  
Wire Rod Chair  
1181 FT2.....275

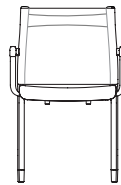

**Wit Side Mesh**  
4-Leg Side Chair  
2221 FT1 MB .....278

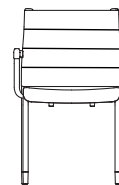

**Wit Side Thintex**  
4-Leg Side Chair  
2221 FT1 TXB .....281

# Achieve

## MULTIPURPOSE CHAIR

### *Own the space.*

Achieve upholstered and plastic side chairs provide the feel of a large chair but with a clean and slender profile. The concave back and contoured seat match the natural curves of the human body, combining comfortable ergonomic support with eye-catching contemporary design. The plastic model's perforated back allows the body to breathe, keeping the user cool while seated.



**EFFECTIVE DECEMBER 1, 2021**

### Featured Models

#### **GOOD :: \$470**

4-leg chair, plastic back and upholstered seat, armless, standard multi-surface glides, grade 1 textile

#### **BETTER :: \$586**

4-leg chair, upholstered seat and back, fixed loop arms, standard multi-surface glides, grade 1 textile

#### **BEST :: \$626**

4-leg chair, upholstered seat and back, fixed loop arms, carpet casters, grade 1 textile

## Features

- Clean and contemporary, ideal for guest and lobby areas, meeting and conference rooms
- Fully upholstered or plastic back with upholstered seat
- Generously proportioned contoured design follows the curves of the body
- Waterfall seat promotes proper leg circulation
- Wall-saver anti-tip frame design
- Additional seat foam option
- 250 lb weight capacity warranty

### 1. Back

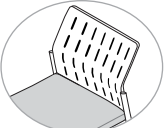
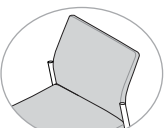
Back and Seat Style	Code	Price	
Black Plastic Back, Upholstered Seat	91 US	\$528	
Upholstered Seat and Back	91 UP	\$586	

### 2. Seat

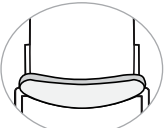
Seat Options	Code	Price	
1" Additional Foam	F1	+\$36	

### 3. Frame

Frame Finish and Style	Code	Price	
Black	FB	+\$0	
Silver	FS	+\$0	
Black With Black Carpet Casters	FCB	+\$40	
Silver With Black Carpet Casters	FCS	+\$40	

## MULTIPURPOSE CHAIR

### 4. Base

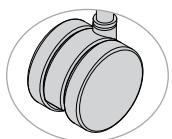
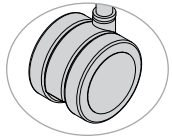
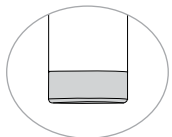
Casters or Glides	Code	Price	
<b>Casters</b>			
Carpet Casters	C13	+\$0	
Hard Floor and Carpet Casters	C12	+\$40	
<b>Glides</b>			
Standard Multi-Surface Glides	G6	+\$0	

Please use caution when stacking models with casters to prevent frame damage. SitOnIt Seating does not warrant scratched frames.

### 5. Arms

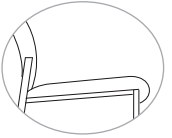
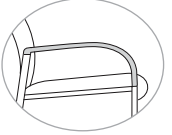
Arm Style	Code	Price	
Armless	A0	-\$58	
Fixed Loop	A40	+\$0	

### 6. Miscellaneous

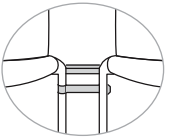
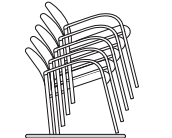
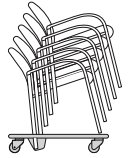
Accessories	Code	Price	
Ganging Bracket for Armless Models	GG4	+\$28	
Ganging Bracket for Models With Arms	GA4	+\$28	
Stacking Cart	14-Cart	+\$324	

Ganging brackets and stacking carts are not intended for use with caster models and are compatible with glides only. See page 538 for additional stacking requirements.

## 7. Material

Protection	Code	Price
CAL 133, Fabric, Quantities 1-49	133F	+ \$99
CAL 133, Fabric, Quantities 50+	133F5	+ \$55
CAL 133, Leather, Any Quantity	133L	+ \$119

Textile	Code	Price
<b>Seat Textile (For US)</b>		
Fabric/Vinyl Grade 1	FG1/VG1	+ \$0
COM	COM	+ \$22
Fabric/Vinyl Grade 2	FG2/VG2	+ \$22
Fabric/Vinyl Grade 3	FG3/VG3	+ \$45
Fabric/Vinyl Grade 4	FG4/VG4	+ \$77
Fabric/Vinyl Grade 5	FG5/VG5	+ \$116
Fabric/Vinyl Grade 6	FG6/VG6	+ \$159
Fabric/Vinyl Grade 7	FG7/VG7	+ \$200
Leather Grade 1	LG1	+ \$140
COL	COL	+ \$200
Leather Grade 2	LG2	+ \$200
Leather Grade 3	LG3	+ \$280

<b>Seat and Back (For UP)</b>		
Fabric/Vinyl Grade 1	FG1/VG1	+ \$0
COM	COM	+ \$34
Fabric/Vinyl Grade 2	FG2/VG2	+ \$34
Fabric/Vinyl Grade 3	FG3/VG3	+ \$74
Fabric/Vinyl Grade 4	FG4/VG4	+ \$121
Fabric/Vinyl Grade 5	FG5/VG5	+ \$174
Fabric/Vinyl Grade 6	FG6/VG6	+ \$235
Fabric/Vinyl Grade 7	FG7/VG7	+ \$296
Leather Grade 1	LG1	+ \$260
COL	COL	+ \$320
Leather Grade 2	LG2	+ \$320
Leather Grade 3	LG3	+ \$400

Please reference the *Textile Reference Guide* for pricing on fabric over grade 7 and leather over grade 3.

## 8. Packaging

Packaging	Code	Price
Fully Assembled in Carton	AC3	+ \$0
Fully Assembled in Carton, Individually Packaged	AC1	+ \$20

## MULTIPURPOSE CHAIR

### SPECIFICATIONS

Model:	91 Multipurpose Chair
<b>Dimensions</b>	
Overall Width Armless	22"
Overall Width With Arms	25"
Overall Depth	24"
Overall Height	33.5"
Seat Width	19.5"
Seat Depth	19"
Seat Height	18"
Back Width	18"
Back Height	16"
<b>Materials</b>	
COM	1 yd (US), 1.75 yd (UP)
COL	17 sq ft (US), 30 sq ft (UP)
<b>Stacking</b>	
Max Cart Stacking	5
Max Floor Stacking	4
<b>Weight and Capacity</b>	
Weight Armless	18 lb
Weight With Arms	21 lb
Weight Capacity Warranty	250 lb

*Upholstered seat only (US). Upholstered seat and back (UP).*



Better

# Anytime

## MULTIPURPOSE CHAIR AND BAR STOOL

### *Grab and go. Anywhere.*

The economical Anytime collection was designed for corporate, government and educational settings where flexibility and style are key requirements. The perforated plastic back (available in 9 designer colors) provides ample ventilation and upholstered pads can be added for increased comfort. You can also specify Anytime as fully upholstered or with an upholstered seat only. Frame colors are either black or silver. The pull handle ensures that the Anytime side chair is ready to go anytime and anywhere it is needed.



### Featured Models

#### **GOOD :: \$290**

4-Leg chair, all plastic, armless, standard multi-surface glides

#### **BETTER :: \$348**

4-Leg chair, upholstered seat, plastic back, armless, standard multi-surface glides



#### **BEST :: \$464**

4-Leg chair, upholstered seat and back, fixed arms, standard multi-surface glides

## Features

- Fully upholstered, upholstered seat or plastic
- Nine plastic colors
- Perforated shell provides ventilation
- Built-in pull handle
- Black or silver tubular frame
- Stacks six on the floor; eight on the optional cart
- 250 lb weight capacity warranty
- Complements Anytime light task chair and stool; see page 46

### 1. Back

Back and Seat Style	Code	Price	
Plastic	No Code	\$290	
Upholstered Seat Only	US	\$348	
Upholstered Seat and Back	UP	\$406	

### 2. Frame

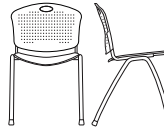
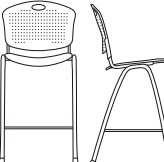
Frame Type	Code	Price	
4-Leg	93	+ \$0	
30" Bar Stool	93 S2	+ \$150	



Bar stools (S2) are available with glides only.

## MULTIPURPOSE CHAIR AND BAR STOOL

### 2. Frame (Cont.)

Frame Finish	Code	Price	
Black	FB	+ \$0	
Black With Casters	FCB	+ \$40	
Silver	FS	+ \$0	
Silver With Casters	FCS	+ \$40	

### 3. Arms

Arm Style	Code	Price	
Armless	A0	+ \$0	
Fixed Loop Arms (Black)	A48	+ \$58	
Fixed Loop Arms (Silver)	A49	+ \$58	

### 4. Base

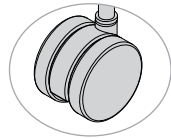
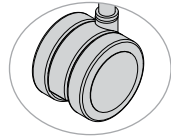
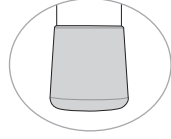
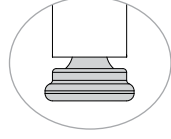
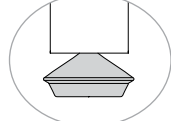
Casters or Glides	Code	Price	
<b>Casters</b>			
Carpet Casters	C13	+ \$0	
Hard Floor and Carpet Casters	C12	+ \$40	
<b>Glides</b>			
Standard Multi-Surface Glide	G7	+ \$0	
Floor Saver Glides	G15	+ \$17	
Steel Glides (Carpet Only)	G14	+ \$17	
Performance Multi-Surface Glides	GL2	+ \$17	

Casters not available with bar stool (S2). Do not stack chairs with casters.

### 5. Miscellaneous

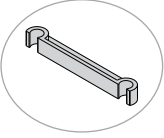
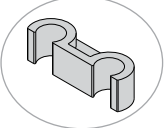
Ganging	Code	Price	
Ganging Bracket for Armless Models	GG6	+ \$30	
Ganging Bracket for Models With Arms	GA6	+ \$30	

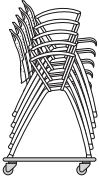
Stacking	Code	Price	
Stacking Cart	93-Cart	+ \$324	

Ganging brackets and stacking carts are not available for caster models and are only available for chairs with glides.

Due to the nature of upholstery, stacking may cause impressions on the seat. SitOnIt Seating does not warrant the effects of stacking on upholstery.

See page 538 for additional stacking requirements.

### 6. Material

Protection	Code	Price	
<b>Fire Retardancy</b>			
CAL 133, Fabric, Quantities 1-49	133F	+ \$99	
CAL 133, Fabric, Quantities 50+	133F5	+ \$55	
CAL 133, Plastic, Any Quantity	133P	+ \$45	

Shell Color	Code	Price	
Arctic	SC21	+ \$0	
Black	SC1	+ \$0	
Chocolate	SC4	+ \$0	
Lagoon	SC15	+ \$0	
Latte	SC20	+ \$0	
Navy	SC5	+ \$0	
Red	SC19	+ \$0	
Slate	SC8	+ \$0	
Sterling	SC18	+ \$0	

### 6. Material (Cont.)

Textile	Code	Price	
<b>Seat Only (For US)</b>			
Fabric/Vinyl Grade 1	FG1/VG1	+ \$0	
COM	COM	+ \$22	
Fabric/Vinyl Grade 2	FG2/VG2	+ \$22	
Fabric/Vinyl Grade 3	FG3/VG3	+ \$45	
Fabric/Vinyl Grade 4	FG4/VG4	+ \$77	
Fabric/Vinyl Grade 5	FG5/VG5	+ \$116	
Fabric/Vinyl Grade 6	FG6/VG6	+ \$159	
Fabric/Vinyl Grade 7	FG7/VG7	+ \$200	
<b>Seat and Back (For UP)</b>			
Fabric/Vinyl Grade 1	FG1/VG1	+ \$0	
COM	COM	+ \$34	
Fabric/Vinyl Grade 2	FG2/VG2	+ \$34	
Fabric/Vinyl Grade 3	FG3/VG3	+ \$74	
Fabric/Vinyl Grade 4	FG4/VG4	+ \$121	
Fabric/Vinyl Grade 5	FG5/VG5	+ \$174	
Fabric/Vinyl Grade 6	FG6/VG6	+ \$235	
Fabric/Vinyl Grade 7	FG7/VG7	+ \$296	

Please reference the Textile Reference Guide for pricing on fabric over grade 7. See page 10 for more information on CAL 133.



## 7. Packaging

Packaging	Code	Price
Fully Assembled in Carton	AC	+ \$0
Fully Assembled in Carton, Individually Packaged	AC1	+ \$20

## SPECIFICATIONS

Model:	93 4-Leg Multipurpose	93 S2 30" Bar Stool
<b>Dimensions</b>		
Overall Width Armless	21.5"	22"
Overall Width With Arms	26.5"	27"
Overall Depth	22"	22"
Overall Height	32.5"	44"
Seat Width	19"	19"
Seat Depth	18"	18"
Seat Height	18"	30.5"
Back Width	21.5"	21.5"
Back Height	14.5"	14.5"
<b>Materials</b>		
COM	0.8 yd (US) 1 yd (UP)	0.8 yd (US) 1 yd (UP)
<b>Stacking</b>		
Max Cart Stacking	8	N/A
Max Floor Stacking	6	N/A
<b>Weight and Capacity</b>		
Weight Armless	14 lb	21.5 lb
Weight With Arms	18 lb	25.5 lb
Weight Capacity Warranty	250 lb	250 lb

*Upholstered seat (US), Upholstered seat and back (UP).*



# Baja

## MULTIPURPOSE CHAIR AND BAR STOOL

### *Immerse in possibilities.*

Let's come together. When you want to feel the room and fill the room, there's Baja. Its comfort, customization, features and function will stand out—all while blending in – and echo the vibe of any space with subtle sophistication. Discover what's possible when you're surrounded by cohesive design.



*Good*

**EFFECTIVE DECEMBER 1, 2021**

### Featured Models

#### **GOOD :: \$345**

All plastic, 4-leg, armless, standard multi-surface glides

#### **BETTER :: \$403**

Plastic back and upholstered seat, 4-leg, armless, standard multi-surface glides, grade 1 textile



#### **BEST :: \$519**

Fully upholstered, 4-leg, fixed arms, standard multi-surface glides, grade 1 textile

## Features

- Scale and sculpture offer a roomier, more comfortable sit
- Seamless design and broad collection create cohesion in any space
- Residential-inspired features and options, including standard and low-back stools
- Responsive, single-piece shell offers 18 degrees of backrest flex
- Bases include wire rod, wire rod stool and 4-leg with casters or glides
- Choose from 14 shell colors, three arm pad colors, two wire rod and three 4-leg finishes
- Stackable on the floor or on a cart for quick clean-up and easy storage
- 300 lb weight capacity warranty

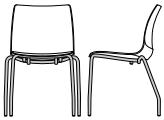
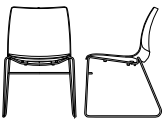

### 1. Frame

Frame Type	Code	Price	
4-Leg	1171 FT1	\$345	
Wire Rod	1171 FT2	\$322	
30" Wire Rod Bar Stool	1171 FT2 S2	\$472	

Frame Finish	Code	Price	
<b>4-Leg (FT1) Only</b>			
Black	FC1	+ \$0	
Silver	FC2	+ \$0	
White	FC12	+ \$0	
<b>Wire Rod (FT2) Only</b>			
Black	FC1	+ \$0	
Chrome	FC15	+ \$0	

## MULTIPURPOSE CHAIR AND BAR STOOL

### 2. Back and Seat

Back Size	Code	Price	
Standard Back	BK4	+ \$0	
Low Back	BK3	+ \$0	

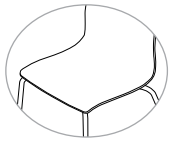
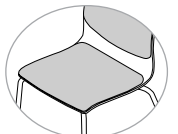
Seat Style	Code	Price	
Plastic Seat	PS	+ \$0	
Upholstered Seat	US	+ \$58	

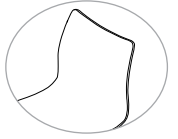
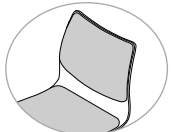

Back Style	Code	Price	
Plastic Back	PB	+ \$0	
Upholstered Back	UB	+ \$58	

*Low back option available for bar stool (S2) only.*

*Upholstered back (UB) option available only with upholstered seat (US) and is not compatible with the low back (BK3) option.*

*Due to the nature of upholstery, stacking may cause impressions on the seat. SitOnIt Seating does not warrant the effects of stacking on upholstery.*

### 3. Arms

Arm Style	Code	Price	
Armless	AR0	+ \$0	
Fixed Arms	AR1	+ \$58	

*Fixed arms available on 4-leg chair (FT1) only. Arm finish matches frame finish. Arm pads are black on the black (FC1) frame or fog on the silver (FC2) and white on the white (FC12) frames.*

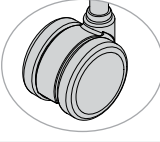
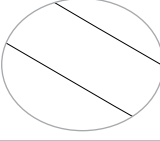

## 4. Base

Casters or Glides	Code	Price	
<b>Casters (For 4-Leg Chair FT1 Only)</b>			
Carpet Casters	CS5	+ \$40	
Hard Floor and Carpet Casters	CS6	+ \$80	
<b>Glides (For 4-Leg Chair FT1 Only)</b>			
Standard Multi-Surface Glides	GL1	+ \$0	
Performance Multi-Surface Glides	GL2	+ \$17	
Floor Saver Glides	GL3	+ \$17	
Steel Glides (Carpet Only)	GL4	+ \$17	
<b>Glides (For Wire Rod FT2 Only)</b>			
No Glides	G0	+ \$0	
Clear Glides	CGR	+ \$9	
Clear Glides With Felt	CGRF	+ \$22	

Casters are black on the black (FC1) frame or fog on the silver (FC2) and white on the white (FC12) frames.

## MULTIPURPOSE CHAIR AND BAR STOOL

## 5. Miscellaneous

Accessories	Code	Price	
Ganging Bracket	GG	+ \$30	
Stacking Cart	CART	+ \$399	

Ganging Brackets (GG) available on armless (AR0) models only.

Please use caution when stacking models with casters to prevent frame damage. SitOnIt Seating does not warrant scratched frames.

See page 538 for additional stacking requirements.



Best

## 6. Material

Shell Color	Code	Price
Black	SC1	+ \$0
Chocolate	SC4	+ \$0
Latte	SC20	+ \$0
Navy	SC5	+ \$0
Slate	SC8	+ \$0
Apple	SC24	+ \$0
Arctic	SC21	+ \$0
Bisque	SC7	+ \$0
Lagoon	SC15	+ \$0
Lemon	SC25	+ \$0
Pacific	SC22	+ \$0
Red	SC19	+ \$0
Sterling	SC18	+ \$0
Tangerine	SC23	+ \$0

Textile	Code	Price
<b>Seat Only (US)</b>		
Fabric/Vinyl Grade 1	FG1/VG1	+ \$0
COM	COM	+ \$22
Fabric/Vinyl Grade 2	FG2/VG2	+ \$22
Fabric/Vinyl Grade 3	FG3/VG3	+ \$45
Fabric/Vinyl Grade 4	FG4/VG4	+ \$77
Fabric/Vinyl Grade 5	FG5/VG5	+ \$116
Fabric/Vinyl Grade 6	FG6/VG6	+ \$159
Fabric/Vinyl Grade 7	FG7/VG7	+ \$200
<b>Seat and Back (US + UB)</b>		
Fabric/Vinyl Grade 1	FG1/VG1	+ \$0
COM	COM	+ \$34
Fabric/Vinyl Grade 2	FG2/VG2	+ \$34
Fabric/Vinyl Grade 3	FG3/VG3	+ \$74
Fabric/Vinyl Grade 4	FG4/VG4	+ \$121
Fabric/Vinyl Grade 5	FG5/VG5	+ \$174
Fabric/Vinyl Grade 6	FG6/VG6	+ \$235
Fabric/Vinyl Grade 7	FG7/VG7	+ \$296

Please reference the Textile Reference Guide for pricing on fabric over grade 7.

## MULTIPURPOSE CHAIR AND BAR STOOL

## 7. Packaging

Packaging	Code	Price
Fully Assembled in Carton	AC	+ \$0
Fully Assembled in Carton, Individually Packaged	AC1	+ \$20

## CHAIR SPECIFICATIONS

Model:	1171 FT1 4-Leg Chair	1171 FT2 Wire Rod Chair
<b>Dimensions</b>		
Overall Width With Arms	27"	N/A
Overall Width Armless	22.25"	22"
Overall Depth	21.5"	22.5"
Overall Height	32.5"	32"
Seat Width	18.5"	18.5"
Seat Depth	18"	18"
Seat Height	18"	17.5"
Back Width	18.25"	18.25"
Back Height	15.75"	16.5"
<b>Materials</b>		
COM	0.75 yd (US) 1 yd (UB)	0.75 yd (US) 1 yd (UB)
<b>Stacking</b>		
Max Cart Stacking Armless	10 (PS) 8 (US/UB)	6 (PS) 4 (US/UB)
Max Cart Stacking With Arms	10 (PS) 8 (US/UB)	N/A
Max Floor Stacking Armless	6 (PS) 4 (US/UB)	6
Max Floor Stacking With Arms	6 (PS) 4 (US/UB)	N/A
<b>Weight and Capacity</b>		
Weight With Arms	18 lb	N/A
Weight Armless	16 lb	15 lb
Weight Capacity Warranty	300 lb	300 lb

Plastic seat (PS). Upholstered seat (US). Upholstered back (UB).

## STOOL SPECIFICATIONS

<b>Model:</b>	1171 FT2 S2 30" Wire Rod Bar Stool
<b>Dimensions</b>	
Overall Width Armless	22"
Overall Depth	22.5"
Overall Height	45" (BK4) 35.25" (BK3)
Seat Width	18.5"
Seat Depth	18"
Seat Height	29.5"
Back Width	18.25"
Back Height	16.5" (BK4) 7" (BK3)
<b>Materials</b>	
COM	0.75 yd (US) 1 yd (UB)
<b>Stacking</b>	
Floor Stacking	4
<b>Weight and Capacity</b>	
Weight Armless	22 lb (BK4) 20 lb (BK3)
Weight Capacity	300 lb

*Upholstered seat (US). Upholstered back (UB). Standard back (BK4). Low back (BK3).*



Better

# Cora

## MULTIPURPOSE SIDE CHAIR

### *Ability for any facility.*

With expert insights from Certified Healthcare Interior Designers® (CHID), Cora was designed to withstand the high demands of our modern spaces. It's a research-driven solution engineered for cleanability, reliability and durability—while ensuring central comfort and cohesion across every model.



**EFFECTIVE DECEMBER 1, 2021**

### Featured Models

#### **GUEST :: \$422**

Guest chair, upholstered back, upholstered seat, fixed arms, standard multipurpose glides, grade 1 textile

#### **MIDSIZE :: \$572**

Midsize chair, upholstered back, upholstered seat, fixed arms, performance multisurface glides, grade 1 textile



#### **BARIATRIC :: \$825**

Bariatric chair, upholstered back, upholstered seat, fixed arms, performance multisurface glides, grade 1 textile

## Features

- Designed with expert insight from Certified Healthcare Interior Designers®
- A high-performing solution for any industry, including corporate, healthcare, education and more
- Easy to maintain with clean-out space and field replaceable components, including seat and back
- Wall-saver frame keeps everything fresh, preventing scuffs and marks
- Looped arms are streamlined yet wide enough to sit down and get up with ease
- Bleach cleanable, multi-upholstery and ballistic nylon options
- Edge-to-edge underseat cover provides full coverage on the guest model for enhanced stacking (four on floor; six on cart)
- Meets Healthier Hospitals Safer Chemicals Challenge 2.3, BIFMA LEVEL, GreenGuard Gold, and BIFMA X5.1 to X5.41
- Curated collection with an array of weight capacity warranties – guest model (500 lb), midsize model (600 lb), and bariatric model (750 lb)

### 1. Frame

Frame Type	Code	Price	
Guest	1191 SW19	\$422	
Midsize	1191 SW26	\$572	
Bariatric	1191 SW30	\$825	

Frame Finish	Code	Price	
Black	FC1	+ \$0	
Silver	FC2	+ \$0	

## MULTIPURPOSE SIDE CHAIR

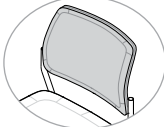

### 2. Back and Seat

Back Style	Code	Price	
Upholstered Back	UB	+ \$0	

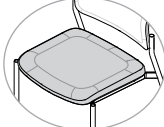

Seat Style	Code	Price	
Upholstered Seat	US	+ \$0	

### 3. Arms

Arm Style	Code	Price	
Armless	AR0	- \$58	
Fixed	AR1	+ \$0	

Arm Cap Finish	Code	Price	
Black	AC3	+ \$0	
Fog	AC6	+ \$0	

Armless (AR0) option is available on guest (SW19) chairs only.



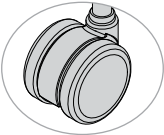
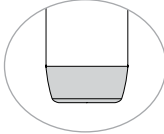
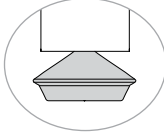
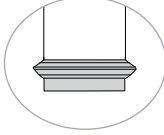
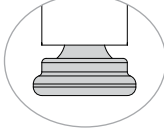

MULTIPURPOSE SIDE CHAIR

4. Base

Casters or Glides	Code	Price	
<b>Casters</b>			
Carpet Casters	CS5	+ \$40	
Hard Floor and Carpet Casters	CS6	+ \$80	
<b>Glides</b>			
Standard Multi-Surface Glides	GL1	+ \$0	
Performance Multi-Surface Glides for Guest Chair	GL2	+ \$17	
Performance Multi-Surface Glides for Midsize or Bariatric Chair	GL2	+ \$0	
Floor Saver Glides	GL3	+ \$17	
Steel Glides (Carpet Only)	GL4	+ \$17	

Caster color coordinates with frame color. Casters (CS5/CS6) and standard multi-surface glides (GL1) are only available on guest (SW19) chairs. Performance multi-surface glides (GL2) are standard on midsize (SW26) or bariatric (SW30) chairs.

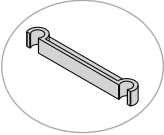
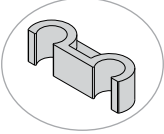
5. Miscellaneous

Accessories	Code	Price	
Ganging Bracket (Fixed Arms Only)	GA	+ \$30	
Ganging Bracket (Armless Only)	GG	+ \$30	
Stacking Cart	CART	+ \$399	

Stacking cart is only compatible with guest (SW19) models and is not compatible with casters (CS5/CS6). See page 538 for additional stacking requirements.

6. Material

Ballistic Nylon	Code	Price	
Ballistic Nylon Back	BN	+ \$0	
<b>Fully Upholstered</b>			
<b>Seat and Back Upholstery</b>		<b>Guest</b>	<b>Midsize/Bariatric</b>
Fabric/Vinyl Grade 1	FG1/VG1	+ \$0	+ \$0
COM	COM	+ \$34	+ \$40
Fabric/Vinyl Grade 2	FG2/VG2	+ \$34	+ \$40
Fabric/Vinyl Grade 3	FG3/VG3	+ \$74	+ \$84
Fabric/Vinyl Grade 4	FG4/VG4	+ \$121	+ \$156
Fabric/Vinyl Grade 5	FG5/VG5	+ \$174	+ \$228
Fabric/Vinyl Grade 6	FG6/VG6	+ \$235	+ \$304
Fabric/Vinyl Grade 7	FG7/VG7	+ \$296	+ \$378
Leather Grade 1	LG1	+ \$140	+ \$240
COL	COL	+ \$200	+ \$540
Leather Grade 2	LG2	+ \$200	+ \$540
Leather Grade 3	LG3	+ \$280	+ \$820
<b>Multi-Upholstery</b>			
<b>Upcharge</b>		<b>Guest</b>	<b>Midsize/Bariatric</b>
Multi-Upholstery Upcharge	UMU	+ \$58	+ \$58
<b>Seat Upholstery Only</b>		<b>Guest</b>	<b>Midsize/Bariatric</b>
Fabric/Vinyl Grade 1	FG1/VG1	+ \$0	+ \$0
COM	COM	+ \$22	+ \$26
Fabric/Vinyl Grade 2	FG2/VG2	+ \$22	+ \$26
Fabric/Vinyl Grade 3	FG3/VG3	+ \$45	+ \$60
Fabric/Vinyl Grade 4	FG4/VG4	+ \$77	+ \$116
Fabric/Vinyl Grade 5	FG5/VG5	+ \$116	+ \$172
Fabric/Vinyl Grade 6	FG6/VG6	+ \$159	+ \$213
Fabric/Vinyl Grade 7	FG7/VG7	+ \$200	+ \$254
Leather Grade 1	LG1	+ \$100	+ \$160
COL	COL	+ \$145	+ \$360
Leather Grade 2	LG2	+ \$145	+ \$360
Leather Grade 3	LG3	+ \$200	+ \$550

Ballistic nylon back (NBN) is not available with multi-upholstery (UMU).

**6. Material (Cont.)**

Multi-Upholstery	Code	Price	
Back Upholstery Only		Guest	Midsized/Bariatric
Fabric/Vinyl Grade 1	FG1/VG1	+ \$0	+ \$0
COM	COM	+ \$18	+ \$22
Fabric/Vinyl Grade 2	FG2/VG2	+ \$18	+ \$22
Fabric/Vinyl Grade 3	FG3/VG3	+ \$39	+ \$45
Fabric/Vinyl Grade 4	FG4/VG4	+ \$63	+ \$77
Fabric/Vinyl Grade 5	FG5/VG5	+ \$91	+ \$116
Fabric/Vinyl Grade 6	FG6/VG6	+ \$123	+ \$159
Fabric/Vinyl Grade 7	FG7/VG7	+ \$154	+ \$200
Leather Grade 1	LG1	+ \$70	+ \$130
COL	COL	+ \$100	+ \$295
Leather Grade 2	LG2	+ \$100	+ \$295
Leather Grade 3	LG3	+ \$140	+ \$450

**7. Packaging**

Subhead	Code	Price	
Fully Assembled in Carton	AC	+ \$0	
Fully Assembled in Carton, Individually Packaged	AC1	+ \$20	

Individual packaging (AC1) is only available for guest (SW19) chairs.

**MULTIPURPOSE SIDE CHAIR**

**SPECIFICATIONS**

Model:	1191 SW19 Guest Chair	1191 SW26 Midsize Chair	1191 SW30 Bariatric Chair
<b>Dimensions</b>			
Overall Width With Arms	24.75"	31.25"	35.5"
Overall Width Armless	21.25"	N/A	N/A
Overall Depth	23"	23"	23"
Overall Height	33.75"	33.75"	33.75"
Seat Width	18.75"	25.75"	29.5"
Seat Depth	17.5"	17.5"	17.5"
Seat Height	18.25"	18.25"	18.25"
Back Width	19"	27.5"	30"
Back Height	15.75"	15.75"	15.75"
<b>Materials</b>			
COM (Back)	0.75 yd	0.95 yd	1.25 yd
COM (Seat)	0.9 yd	1 yd	1.25 yd
COM (Seat and Back)	1.25 yd	1.75 yd	2 yd
COL (Back)	12 sq ft	15 sq ft	18 sq ft
COL (Seat)	14 sq ft	17 sq ft	21 sq ft
COL (Seat and Back)	21 sq ft	27 sq ft	30 sq ft
<b>Stacking</b>			
Max Cart Stacking	6	N/A	N/A
Max Floor Stacking	4	N/A	N/A
<b>Weight and Capacity</b>			
Weight With Arms	24.5	37	42.5
Weight Armless	23"	N/A	N/A
Weight Capacity Warranty	500 lb	600 lb	750 lb

# Cora

## REPLACEMENT SEATING PARTS

### Replacement Parts: Seats

Seat Size	Code	Price	
Guest Seat	SEAT	\$70	
Midback Seat	SEAT	\$85	
Bariatric Seat	SEAT	\$120	
Multi-Upholstery	Code	Price	
Seat Upholstery Only		Guest	Midsize/Bariatric
Fabric/Vinyl Grade 1	FG1/VG1	+ \$0	+ \$0
COM	COM	+ \$22	+ \$26
Fabric/Vinyl Grade 2	FG2/VG2	+ \$22	+ \$26
Fabric/Vinyl Grade 3	FG3/VG3	+ \$45	+ \$60
Fabric/Vinyl Grade 4	FG4/VG4	+ \$77	+ \$116
Fabric/Vinyl Grade 5	FG5/VG5	+ \$116	+ \$172
Fabric/Vinyl Grade 6	FG6/VG6	+ \$159	+ \$213
Fabric/Vinyl Grade 7	FG7/VG7	+ \$200	+ \$254
Leather Grade 1	LG1	+ \$100	+ \$160
COL	COL	+ \$145	+ \$360
Leather Grade 2	LG2	+ \$145	+ \$360
Leather Grade 3	LG3	+ \$200	+ \$550

### Replacement Parts: Back

Seat Size	Code	Price	
Guest Back	BACK	\$90	
Midback Back	BACK	\$120	
Bariatric Back	BACK	\$160	
Multi-Upholstery	Code	Price	
Back Upholstery Only		Guest	Midsize/Bariatric
Fabric/Vinyl Grade 1	FG1/VG1	+ \$0	+ \$0
COM	COM	+ \$18	+ \$22
Fabric/Vinyl Grade 2	FG2/VG2	+ \$18	+ \$22
Fabric/Vinyl Grade 3	FG3/VG3	+ \$39	+ \$45
Fabric/Vinyl Grade 4	FG4/VG4	+ \$63	+ \$77
Fabric/Vinyl Grade 5	FG5/VG5	+ \$91	+ \$116
Fabric/Vinyl Grade 6	FG6/VG6	+ \$123	+ \$159
Fabric/Vinyl Grade 7	FG7/VG7	+ \$154	+ \$200
Leather Grade 1	LG1	+ \$70	+ \$130
COL	COL	+ \$100	+ \$295
Leather Grade 2	LG2	+ \$100	+ \$295
Leather Grade 3	LG3	+ \$140	+ \$450

# Focus Side

MULTIPURPOSE CHAIR, COUNTER AND BAR STOOL

*Where comfort, style and ergonomics converge.*

The revitalized Focus™ Side combines comfort and design for multi-purpose, office or reception areas. Choose either the 4-leg side chair, bar or counter stools in 3 back options – mesh, upholstered and wood. Two different frame finishes permit it to blend in—or stand out. Focus Side is part of a broad and versatile collection that includes executive and task models. Designed to complement Focus and Amplify task chairs.



*Good*

**EFFECTIVE DECEMBER 1, 2021**

## Featured Models

### **GOOD :: \$435**

Upholstered seat, mesh back, standard multi-surface glides, armless, grade 1 textile

### **BETTER :: \$493**

Upholstered seat, mesh back, standard multi-surface glides, arms, grade 1 textile

### **BEST :: \$658**

Upholstered seat, clear maple slotted wood back, arms, carpet casters, grade 1 textile

### Features

- 4-leg side chair, 30" bar and 24" counter stool models
- Three back options: mesh, wood and fully upholstered
- 15 bleach-cleanable mesh back colors
- Two wood back styles and 4 wood stain finishes
- Black or silver frame
- Upholstered waterfall seat
- Mesh back model stacks four on the floor, five on the optional cart; upholstered back model stacks three on the floor, three on the optional cart
- 300 lb weight capacity warranty
- Complements Focus and Focus 2.0 task chairs and stools; see page 51 and page 69



Better

### 1. Frame

Model and Frame Finish	Code	Price	
<b>Chairs</b>			
Black	5651	\$493	
Silver	5652	\$493	
Black With Black Carpet Casters	5641	\$533	
Silver With Black Carpet Casters	5642	\$533	
<b>Stools</b>			
24" Black Counter Stool	5651 S9	\$643	
24" Silver Counter Stool	5652 S9	\$643	
30" Black Bar Stool	5651 S2	\$643	
30" Silver Bar Stool	5652 S2	\$643	





### 2. Back

Back Style	Code	Price	
Mesh	B1	+\$0	
Upholstered	B3	+\$0	
Solid Wood	WB1	+\$125	
Slotted Wood	WB2	+\$125	

# FOCUS SIDE

EFFECTIVE DECEMBER 1, 2021 | GSA SIN #: 33721

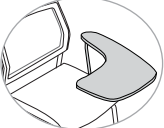
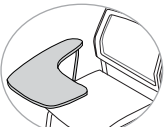
## 3. Arms

Arm Style	Code	Price	
Armless	A0	- \$58	
Fixed Loop	A130	+ \$0	
Tablet Arm	Code	Price	
3-Week Lead Time			
Tablet Arm, Left	TLS	+ \$98	
Tablet Arm, Right	TRS	+ \$98	
Oversized Tablet Arm	TSO	+ \$130	

Tablet arms are not available with stools or casters. Not stackable.

## 4. Base

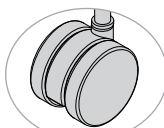
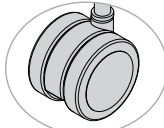
Casters and Glides	Code	Price	
Casters			
Carpet Casters	C13	+ \$0	
Hard Floor and Carpet Casters	C12	+ \$40	



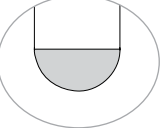
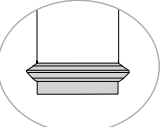
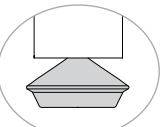
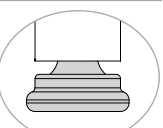

# MULTIPURPOSE CHAIR, COUNTER STOOL AND BAR STOOL

## 4. Base (Cont.)

Casters and Glides	Code	Price	
Glides			
Standard Multi-Surface Glides	G5	+ \$0	
Floor Saver Glides	G12	+ \$17	
Performance Multi-Surface Glides	GL2	+ \$17	
Steel Glides (Carpet Only)	G13	+ \$17	

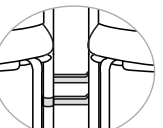
Please use caution when stacking models with casters to prevent frame damage. SitOnIt Seating does not warrant scratched frames. Casters are not available on counter stool (S9) or bar stool (S2).

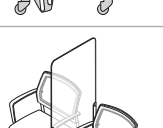
## 5. Miscellaneous

Accessories	Code	Price	
Ganging Bracket for Armless Models	GG11	+ \$30	
Ganging Bracket for Models With Arms	GA11	+ \$30	
Stacking Cart	56-Cart	+ \$324	
Sector Seating Screen	3097 52X	+ \$460	

Ganging brackets and stacking carts are not intended for use with caster models or stools and are compatible with glides only. Wood back chairs (WB1/WB2) are not stackable. See page 3 for additional stacking requirements.

See Sector Seating Screens on page 500 for more specification details.

## MULTIPURPOSE CHAIR, COUNTER STOOL AND BAR STOOL

### 6. Material

Protection	Code	Price	
<b>Fire Retardancy</b>			
CAL 133, Fabric, Quantities 1–49	133F	+ \$99	
CAL 133, Fabric, Quantities 50+	133F5	+ \$55	
CAL 133, Leather, Any Quantity	133L	+ \$119	
Mesh Color (For B1)	Code	Price	
<b>Matches Amplify</b>			
Apple	MC31	+ \$0	
Aqua	MC30	+ \$0	
Desert	MC9	+ \$0	
Electric Blue	MC24	+ \$0	
Fire	MC10	+ \$0	
Fog	MC7	+ \$0	
Navy	MC8	+ \$0	
Nickel	MC6	+ \$0	
Onyx	MC5	+ \$0	
Tangerine	MC28	+ \$0	
<b>Matches Focus</b>			
Black	MC1	+ \$0	
Sand	MC3	+ \$0	
Slate	MC2	+ \$0	
Freeway Sport Stripe (Black/Slate)	MC33	+ \$0	
Impress Sport Stripe (Slate/Black)	MC34	+ \$0	
Wood Stain (For WB)	Code	Price	
Amber Mahogany	S5	+ \$0	
Clear Maple	S1	+ \$0	
Espresso	S8	+ \$0	
Medium Cherry	S3	+ \$0	
Stain-to-Match	SM	+ \$55	

*Stain-to-Match (SM): If stain is not in our library, add a one-time \$350 fee. There is a 15-day lead time for stain-to-match.*

### 6. Material (Cont.)

Textile	Code	Price	
<b>Seat Only (For B1/WB)</b>			
Fabric/Vinyl Grade 1	FG1/VG1	+ \$0	
COM	COM	+ \$22	
Fabric/Vinyl Grade 2	FG2/VG2	+ \$22	
Fabric/Vinyl Grade 3	FG3/VG3	+ \$45	
Fabric/Vinyl Grade 4	FG4/VG4	+ \$77	
Fabric/Vinyl Grade 5	FG5/VG5	+ \$116	
Fabric/Vinyl Grade 6	FG6/VG6	+ \$159	
Fabric/Vinyl Grade 7	FG7/VG7	+ \$200	
Leather Grade 1	LG1	+ \$140	
COL	COL	+ \$200	
Leather Grade 2	LG2	+ \$200	
Leather Grade 3	LG3	+ \$280	
<b>Seat and Back (For B3)</b>			
Fabric/Vinyl Grade 1	FG1/VG1	+ \$0	
COM	COM	+ \$34	
Fabric/Vinyl Grade 2	FG2/VG2	+ \$34	
Fabric/Vinyl Grade 3	FG3/VG3	+ \$74	
Fabric/Vinyl Grade 4	FG4/VG4	+ \$121	
Fabric/Vinyl Grade 5	FG5/VG5	+ \$174	
Fabric/Vinyl Grade 6	FG6/VG6	+ \$235	
Fabric/Vinyl Grade 7	FG7/VG7	+ \$296	
Leather Grade 1	LG1	+ \$260	
COL	COL	+ \$320	
Leather Grade 2	LG2	+ \$320	
Leather Grade 3	LG3	+ \$400	

*Please reference the Textile Reference Guide for pricing on fabric over grade 7 or leather over grade 3. Additional CAL 133 information can be found on page 10.*

### 7. Packaging

Packaging	Code	Price	
Fully Assembled in Carton (Chairs)	AC3	+ \$0	
Fully Assembled in Carton, Individually Packed Chairs	AC1	+ \$20	
Fully Assembled in Carton, Individually Packed Stools	AC1	+ \$0	

# FOCUS SIDE

EFFECTIVE DECEMBER 1, 2021 | GSA SIN #: 33721

## CHAIR SPECIFICATIONS

Model:	5651 / 5652 Side Chair	5641 / 5642 Side Chair with Casters
<b>Dimensions</b>		
Overall Width Armless	20.5"	20.5"
Overall Width With Arms	24.5"	24.5"
Overall Depth	26" (B1/WB) 25" (B3)	26" (B1/WB) 25" (B3)
Overall Height	34" (B1) 32.5" (B3/WB)	34" (B1) 32.5" (B3/WB)
Seat Width	18"	18"
Seat Depth	18.5"	18.5"
Seat Height	18"	18"
Back Width	20.5"	20.5"
Back Height	18"	18"
<b>Materials</b>		
COM	1 yd (B1/WB) 1.25 yd (B3)	1 yd (B1/WB) 1.25 yd (B3)
COL	12 sq ft (B1/WB) 20 sq ft (B3)	12 sq ft (B1/WB) 20 sq ft (B3)
<b>Stacking</b>		
Maximum Cart Stacking	5 (B1 Only) 3 (B3 Only)	5 (B1 Only) 3 (B3 Only)
Maximum Floor Stacking	4 (B1 Only) 3 (B3 Only)	4 (B1 Only) 3 (B3 Only)
Cart Stacking Weight Armless	133.5 lb	Not Recommended
Cart Stacking Weight With Arms	148.5 lb	Not Recommended
Floor Stacking Weight Armless	84 lb	Not Recommended
Floor Stacking Weight With Arms	96 lb	Not Recommended
<b>Weight and Capacity</b>		
Weight Armless	21 lb (B1/B3) 22 lb (WB)	21 lb (B1/B3) 22 lb (WB)
Weight With Arms	24 lb (B1/B3) 25 lb (WB)	24 lb (B1/B3) 25 lb (WB)
Weight Capacity Warranty	300 lb	300 lb

Mesh back (B1). Upholstered back (B3). Wood back (WB).

## MULTIPURPOSE CHAIR, COUNTER STOOL AND BAR STOOL

## STOOL SPECIFICATIONS

	5651 S9 / 5652 S9 24" Counter Stool	5652 S1 / 5652 S2 30" Bar Stool
<b>Dimensions</b>		
Overall Width Armless	20.5"	20.5"
Overall Width With Arms	24.5"	24.5"
Overall Depth	26" (B1/WB) 25" (B3)	26" (B1/WB) 25" (B3)
Overall Height	39.5" (B1) 37" (B3/WB)	46.5" (B1) 44" (B3/WB)
Seat Width	18"	18"
Seat Depth	18.5"	18.5"
Seat Height	24"	31"
Back Width	20.5"	20.5"
Back Height	18"	18"
<b>Materials</b>		
COM	1 yd (B1/WB) 1.25 yd (B3)	1 yd (B1/WB) 1.25 yd (B3)
COL	17 sq ft (B1/WB) 20 sq ft (B3)	17 sq ft (B1/WB) 20 sq ft (B3)
<b>Weight and Capacity</b>		
Weight Armless	28 lb (B1/B3) 29 lb (WB)	30 lb (B1/B3) 31 lb (WB)
Weight With Arms	31 lb (B1) 32 lb (B3/WB)	33 lb (B1) 34 lb (B3/WB)
Weight Capacity Warranty	300 lb	300 lb

Mesh back (B1). Upholstered back (B3). Wood back (WB).





# Freelance

MULTIPURPOSE CHAIR, COUNTER STOOL AND BAR STOOL

*Built for durability.*

*Imagine the versatility.*

The transitional design of Freelance side chairs works well in lobby areas, workstations and offices. The comfortable, curved seat and structural integrity has made it a high-demand, multipurpose chair. Three frame/arm finish combinations create variety. Add casters or book rack for ultimate mobility and flexibility in training rooms and collaborative spaces. Freelance is a broad collection of 4-leg, sled, counter and bar stools.



EFFECTIVE DECEMBER 1, 2021

## Featured Models

**GOOD :: \$424**

4-leg chair, all plastic seat and back, arms, standard multi-surface glides

**BETTER :: \$482**

4-leg chair, upholstered seat and back, arms, standard multi-surface glides, grade 1 textile

**BEST :: \$522**

4-leg upholstered seat and back, arms, casters, grade 1 textile



# FREELANCE

EFFECTIVE DECEMBER 1, 2021 | GSA SIN #: 33721

## Features

- Fully upholstered, upholstered seat or plastic
- Nine plastic colors
- Three frame/arm finish combinations: black, bisque and silver/slate. (Bisque not available on stool models.)
- Waterfall seat
- Molded shroud underside
- Wall-saver frame design
- Optional book rack
- Stacks 4 on floor, 6 on the optional cart (chairs with sled bases do not stack)
- 250 lb weight capacity warranty for plastic chairs; 300 lb weight capacity warranty for upholstered chairs; 350 lb Heavy Duty 24/7 weight capacity warranty

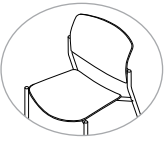
### 1. Back

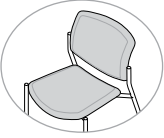
Back and Seat Style	Code	Price	
Plastic	No Code	\$424	
Upholstered Seat	US	\$461	
Upholstered Seat and Back	UP	\$482	

### 2. Heavy Duty

Heavy Duty Series	Code	Price	
Heavy Duty	HD	+ \$306	



Heavy Duty option only available on upholstered 4-leg chair frame (521) with glides. See page 536 for additional LT and HD options.

## MULTIPURPOSE CHAIR, COUNTER STOOL AND BAR STOOL

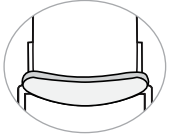

### 3. Seat

Seat Options	Code	Price	
1" Additional Foam	F1	+ \$36	

### 4. Frame

Frame Type	Code	Price	
<b>Chairs</b>			
4-Leg Chair	521X	+ \$0	
4-Leg Chair With Carpet Casters	522X	+ \$40	
Sled Base Chair	523X	+ \$126	

### Stools

24" Counter Stool	5214 S9	+ \$150	
30" Bar Stool	5214 S2	+ \$150	

Frame Finish	Code	Price	
<b>2-Day Lead Time</b>			
Black	FB	+ \$0	
Silver	FS	+ \$0	
<b>3-Week Lead Time</b>			
Bisque	FC7	+ \$0	





Arm color will match the frame color unless otherwise specified. Sled base is not stackable. "x" = arm or armless; see arms section on the following page.

Bisque frame finish is not available on stools.

# FREELANCE

EFFECTIVE DECEMBER 1, 2021 | GSA SIN #: 33721

## 5. Arms

Arm Style	Code	Price	
<b>For Chairs</b>			
Armless (Append Arm Code to Frame Type Code)	XXX3	-\$58	
Fixed Loop Arms (Append Arm Code to Frame Type Code)	XXX4	+\$0	
<b>For Stools</b>			
Armless	5213	-\$58	
Fixed Loop Arms	5214	+\$0	

Arm Color	Code	Price	
<b>2-Day Lead Time</b>			
Black	AC3	+\$0	
Slate	AC4	+\$0	
<b>3-Week Lead Time</b>			
Bisque	AC5	+\$0	

Arm color will match the frame color unless specified otherwise. Bisque (AC5) arm is not available on stool models (S2/S9).

## 6. Base

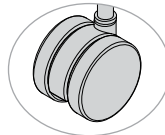
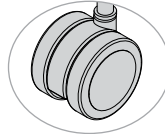
Casters or Glides	Code	Price	
<b>Casters</b>			
Carpet Casters	C13	+\$0	
Hard Floor and Carpet Casters	C12	+\$40	
<b>Glides for Sled Base (523x)</b>			
No Glides	N	+\$0	
Glides	G3	+\$30	

Casters are not available on stool models.

## MULTIPURPOSE CHAIR, COUNTER STOOL AND BAR STOOL

## 6. Base (Cont.)

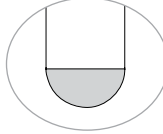
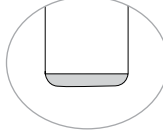
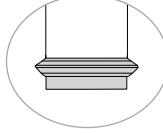
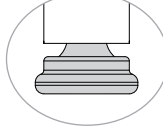
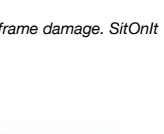
Arm Color	Code	Price	
<b>Glides for 4-Leg Chair (521X/522X) and Stool (S2/S9)</b>			
Standard Multi-Surface Glides	G5	+\$0	
Performance Multi-Surface Glides	GL2	+\$17	
Performance Multi-Surface Glides for Heavy Duty Option Only	GL2	+\$0	
Floor Saver Glides	G12	+\$17	
Steel Glides (Carpet Only)	G13	+\$17	



Glides (GL2) are standard for Heavy Duty (HD) option.

Please use caution when stacking models with casters to prevent frame damage. SitOnIt Seating does not warrant scratched frames.

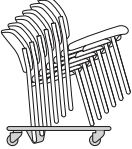
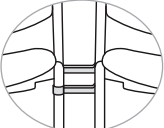
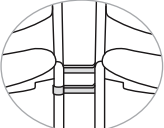

Good

## 7. Miscellaneous

Accessories	Code	Price	
Book Rack (Black)	BRF	+ \$79	
Stacking Cart	14-Cart	+ \$324	
Ganging Bracket for Armless Models	GG2	+ \$30	
Ganging Bracket for Models With Arms	GA2	+ \$30	
Sector Seating Screen	3097 56X	+ \$460	

Accessories are not compatible with stool models (S2/(S9).

Book rack for 4-leg frame only. Book rack (BRF) and stacking cart (14-cart) are not for use with caster models (522x). See page 538 for additional stacking requirements.

Please use caution when stacking models with casters to prevent frame damage. SitOnIt Seating does not warrant scratched frames.

See Sector Seating Screens on page 500 for additional specification details.

## 8. Material

Protection	Code	Price	
<b>Fire Retardancy</b>			
CAL 133, Fabric, Quantities 1-49	133F	+ \$99	
CAL 133, Fabric, Quantities 50+	133F5	+ \$55	
CAL 133, Plastic, Any Quantity	133P	+ \$45	
<b>Ballistic Nylon Back</b>	<b>Code</b>	<b>Price</b>	
Ballistic Nylon Back	BN	+ \$0	

## MULTIPURPOSE CHAIR, COUNTER STOOL AND BAR STOOL

### 8. Material (Cont.)

Shell Color	Code	Price	
Arctic	SC21	+ \$0	
Black	SC1	+ \$0	
Chocolate	SC4	+ \$0	
Lagoon	SC15	+ \$0	
Latte	SC20	+ \$0	
Navy	SC5	+ \$0	
Red	SC19	+ \$0	
Slate	SC8	+ \$0	
Sterling	SC18	+ \$0	
<b>Textile</b>	<b>Code</b>	<b>Price</b>	
<b>Seat Only (For US)</b>			
Fabric/Vinyl Grade 1	FG1/VG1	+ \$0	
COM	COM	+ \$22	
Fabric/Vinyl Grade 2	FG2/VG2	+ \$22	
Fabric/Vinyl Grade 3	FG3/VG3	+ \$45	
Fabric/Vinyl Grade 4	FG4/VG4	+ \$77	
Fabric/Vinyl Grade 5	FG5/VG5	+ \$116	
Fabric/Vinyl Grade 6	FG6/VG6	+ \$159	
Fabric/Vinyl Grade 7	FG7/VG7	+ \$200	
<b>Seat and Back (UP)</b>			
Fabric/Vinyl Grade 1	FG1/VG1	+ \$0	
COM	COM	+ \$34	
Fabric/Vinyl Grade 2	FG2/VG2	+ \$34	
Fabric/Vinyl Grade 3	FG3/VG3	+ \$74	
Fabric/Vinyl Grade 4	FG4/VG4	+ \$121	
Fabric/Vinyl Grade 5	FG5/VG5	+ \$174	
Fabric/Vinyl Grade 6	FG6/VG6	+ \$235	
Fabric/Vinyl Grade 7	FG7/VG7	+ \$296	
Leather/Ballistic Grade 1	LG1/BN1	+ \$140	
COL	COL	+ \$249	
Leather/Ballistic Grade 2	LG2/BN2	+ \$249	
Leather/Ballistic Grade 3	LG3/BN3	+ \$321	

Please reference the Textile Reference Guide for pricing on fabric over grade 7 and leather over grade 3. Additional CAL 133 information can be found on page 10.

## MULTIPURPOSE CHAIR, COUNTER STOOL AND BAR STOOL

### 9. Packaging

Packaging	Code	Price
Fully Assembled Sled Chair in Carton, Individually Packaged	AC1	+ \$0
Fully Assembled Stools in a Carton	AC	+ \$0
<b>4-Leg Models</b>		
Fully Assembled in Carton, When 3 Are Ordered	3C	+ \$0
Fully Assembled in Carton, When 2 Are Ordered	2C	+ \$10
Fully Assembled in Carton, Individually Packaged	AC1	+ \$20

### CHAIR SPECIFICATIONS

Model:	5213 / 5214 5223 / 5224 4-Leg Chair	5233 / 5234 Sled Base Chair
<b>Dimensions</b>		
Overall Width Armless	21.5"	21.5"
Overall Width With Arms	25"	25"
Overall Depth	24"	25"
Overall Height	33.25"	33.25"
Seat Width	19.5"	19.5"
Seat Depth	18.5"	18.5"
Seat Height	17.5"	17.5"
Back Width	19.5"	19.5"
Back Height	16"	16"
<b>Materials</b>		
COM	.99 yd (US) .99 yd (US) (BN) 1.25 yd (UP) 1.15 yd (UP) (BN)	.99 yd (US) .99 yd (US) (BN) 1.25 yd (UP) 1.15 yd (UP) (BN)
COL	15 sq ft (US) 15 sq ft (US) (BN) 25 sq ft (UP) 21 sq ft (UP) (BN)	15 sq ft (US) 15 sq ft (US) (BN) 25 sq ft (UP) 21 sq ft (UP) (BN)
<b>Stacking</b>		
Max Cart Stacking	6	N/A
Max Floor Stacking	4	N/A
<b>Weight and Capacity</b>		
Weight Armless	26.5 lb	27.5 lb
Weight With Arms	28.5 lb	29.5 lb
Weight Armless (3 Pack)	80 lb	N/A
Weight With Arms (3 Pack)	86 lb	N/A
Weight Capacity	250 lb (Plastic/US)	250 lb (Plastic/US)
Warranty	300 lb (UP) 350 lb (HD)	300 lb (UP) (N/A)

*Upholstered seat only (US). Upholstered seat and back (UP). Ballistic nylon (BN). Heavy Duty (HD).*



# FREELANCE

EFFECTIVE DECEMBER 1, 2021 | GSA SIN #: 33721

## STOOL SPECIFICATIONS

Model:	5213 S9 / 5214 S9 24" Counter Stool	5213 S2 / 5214 S2 30" Bar Stool
<b>Dimensions</b>		
Overall Width Armless	21.5"	21.5"
Overall Width With Arms	25"	25"
Overall Depth	24"	24"
Overall Height	39"	45"
Seat Width	19.5"	19.5"
Seat Depth	18.5"	18.5"
Seat Height	24"	30"
Back Width	19.5"	19.5"
Back Height	16"	16"
<b>Materials</b>		
COM	0.99 yd (US) 0.99 yd (US) (BN) 1.25 yd (UP) 1.15 yd (UP) (BN)	0.99 yd (US) 0.99 yd (US) (BN) 1.25 yd (UP) 1.15 yd (UP) (BN)
COL	15 sq ft (US) 15 sq ft (US) (BN) 25 sq ft (UP) 21 sq ft (UP) (BN)	15 sq ft (US) 15 sq ft (US) (BN) 25 sq ft (UP) 21 sq ft (UP) (BN)
<b>Weight and Capacity</b>		
Weight Armless	24 lb	26 lb
Weight With Arms	26 lb	28 lb
Weight Capacity	250 lb (Plastic)	250 lb (Plastic)
Warranty	300 lb (US/UP)	300 lb (US/UP)

*Upholstered seat only (US). Upholstered seat and back (UP). Ballistic nylon back (BN).*



Stool

# Freelance

## BARIATRIC CHAIR

*Built for durability. Imagine the versatility.*

The transitional design of Freelance bariatric side chairs works well in lobby areas and offices. The comfortable, curved seat and structural integrity has made it a high-demand, multipurpose chair. Three frame/arm finish combinations create variety. The Freelance collection is ideal for heavy-duty and bariatric applications.



30" Bariatric

EFFECTIVE DECEMBER 1, 2021

### Featured Models

#### **30" BARIATRIC :: \$882**

30" bariatric side, performance multi-surface glides, grade 1 textile

#### **42" BARIATRIC :: \$1,299**

42" bariatric side, performance multi-surface glides, grade 1 textile

### Features

- Three frame/arm finish combinations: black, bisque and silver/sate
- Waterfall seat
- Molded shroud underside
- Wall-saver frame design
- 500 lb weight capacity warranty on 30" model; 1,000 lb capacity on 42" model

#### 1. Seat

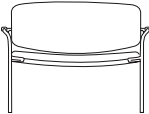
Seat Size	Code	Price	
30" Seat With Arms	5314	\$882	
42" Seat With Arms	5414	\$1,299	

#### 2. Frame

Frame Finish	Code	Price	
<b>2-Day Lead Time</b>			
Black	FB	+ \$0	
Silver	FS	+ \$0	
<b>3-Week Lead Time</b>			
Bisque	FC7	+ \$0	

Arm color will match the frame color unless otherwise specified.

#### 3. Base

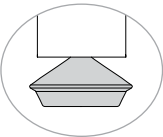
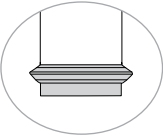
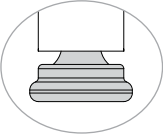
Glides	Code	Price	
Performance Multi-Surface Glides	GL2	+ \$0	
Floor Saver Glides	G12	+ \$17	
Steel Glides (Carpet Only)	G13	+ \$17	



42" Bariatric



## 4. Arms

Arm Color	Code	Price
Bisque	AC5	+ \$0
Black	AC3	+ \$0
Slate	AC4	+ \$0



Arm color will match the frame color unless otherwise specified.

## 5. Material

Protection	Code	Price
<b>Fire Retardancy</b>		
CAL 133, Fabric, Quantities 1-49	133F	+ \$99
CAL 133, Fabric, Quantities 50+	133F5	+ \$55
CAL 133, Leather, Any Quantity	133L	+ \$119
Ballistic Nylon Back	Code	Price
Ballistic Nylon Back	BN	+ \$0
Seat and Back Textile	Code	Price
Fabric/Vinyl Grade 1	FG1/VG1	+ \$0
COM	COM	+ \$40
Fabric/Vinyl Grade 2	FG2/VG2	+ \$40
Fabric/Vinyl Grade 3	FG3/VG3	+ \$84
Fabric/Vinyl Grade 4	FG4/VG4	+ \$156
Fabric/Vinyl Grade 5	FG5/VG5	+ \$228
Fabric/Vinyl Grade 6	FG6/VG6	+ \$304
Fabric/Vinyl Grade 7	FG7/VG7	+ \$378
Leather Grade 1	LG1	+ \$240
COL	COL	+ \$540
Leather Grade 2	LG2	+ \$540
Leather Grade 3	LG3	+ \$820
Leather/Ballistic Grade 2	BN2	+ \$379
Leather/Ballistic Grade 3	BN3	+ \$631

Please reference the Textile Reference Guide for pricing on fabric over grade 7 and leather over grade 3. Additional CAL 133 information can be found on page 10.

## BARIATRIC CHAIR

## 6. Packaging

Packaging	Code	Price
Fully Assembled in a Carton	AC	+ \$0

## SPECIFICATIONS

Model:	5314 30" Bariatric Chair	5414 42" Bariatric Chair
<b>Dimensions</b>		
Overall Width With Arms	36.5"	48.5"
Overall Depth	25.5"	25.5"
Overall Height	32.5"	35"
Seat Width	30"	42"
Seat Depth	19"	18"
Seat Height	19"	19"
Back Width	30"	42"
Back Height	16"	16"
<b>Materials</b>		
COM	2.25 yd 1.67 yd (BN)	2.5 yd 1.75 yd (BN)
COL	40 sq ft 30 sq ft (BN)	42 sq ft 40 sq ft (BN)
<b>Weight and Capacity</b>		
Weight With Arms	42.5 lb	62.5 lb
Weight Capacity Warranty	500 lb	1,000 lb

Ballistic nylon (BN).

# InFlex

MULTIPURPOSE CHAIR, COUNTER STOOL AND BAR STOOL

## *Geometry in motion.*

Designed by Giancarlo Piretti, this multipurpose, stacking chair offers contemporary styling and spine-friendly comfort—at an affordable price.

Versatile InFlex comes in both plastic stacking side models and upholstered side, task and stool versions. The contemporary styling of this Piretti chair emulates the human spine. Its innovative flex-back disc system, with 13 degrees of back angle range, is as clever as it is comfortable.



**EFFECTIVE DECEMBER 1, 2021**

## Featured Models

### **GOOD :: \$327**

4-leg chair, all plastic seat and back, armless, standard multi-surface glides

### **BETTER :: \$385**

4-leg chair, plastic back, upholstered seat, armless, standard multi-surface glides, grade 1 textile

### **BEST :: \$501**



4-leg chair, upholstered seat and back, fixed cantilever arms, standard multi-surface glides, grade 1 textile

## MULTIPURPOSE CHAIR, COUNTER STOOL AND BAR STOOL

### Features

- Giancarlo Piretti design
- Innovative disc system emulates the human spine
- Plastic model stack five on the floor, 12 on the optional cart
- Upholstered armless model stack five on the floor; 10 on the optional cart
- Fully upholstered, upholstered seat or plastic
- Nine plastic colors
- Two frame finishes
- 300 lb weight capacity warranty
- Complements InFlex light task chair and stool; see page 82

### 1. Back

Seat and Back Style	Code	Price	
Plastic Seat and Back	No Code	\$327	
Upholstered Seat Only	US	\$385	
Upholstered Seat and Back	UP	\$443	

Do not stack upholstered chairs with arms.



### 2. Frame

Frame Type	Code	Price	
4-Leg	971	+ \$0	
4-Leg With Black Carpet Casters	974	+ \$40	
24" Counter Stool	971 S9	+ \$150	
30" Bar Stool	971 S2	+ \$150	

Frame Finish	Code	Price	
Black	FC1	+ \$0	
Silver	FC2	+ \$0	

Counter (S9) and bar (S2) stools are available with glides only.

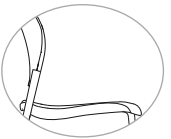
### Arms

Arm Style	Code	Price	
Armless	A0	+ \$0	
Fixed Cantilever	A121	+ \$58	

## MULTIPURPOSE CHAIR, COUNTER STOOL AND BAR STOOL

### 3. Arms (Cont.)

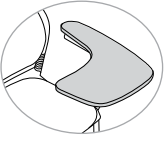
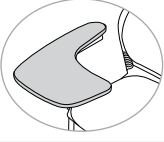
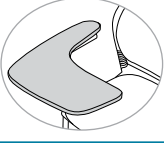
Tablet Arms	Code	Price	
3-Week Lead Time			
Tablet Arm, Left	TLI	+ \$156	
Tablet Arm, Right	TRI	+ \$156	
Oversized Tablet Arm, Right	TIO	+ \$188	
Tablet Laminate Color	Code	Price	
Black	1	+ \$0	
Grey Nebula	5	+ \$0	
Tablet Edge Color	Code	Price	
Black	TE1	+ \$0	

Tablet arms are not available with stools or casters. Not stackable. Tablet arms are not available with stools or casters. Not stackable.

### 4. Base

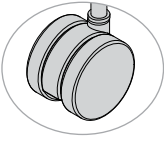
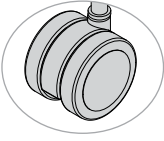
Casters or Glides	Code	Price	
Casters			
Carpet Casters	C13	+ \$0	
Hard Floor and Carpet Casters	C12	+ \$40	

### 4. Base (Cont.)

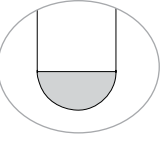
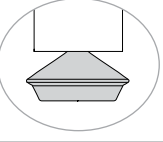
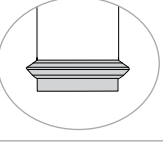
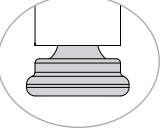
Casters or Glides (Cont.)	Code	Price	
Glides			
Standard Multi-Surface Glides	G11	+ \$0	
Performance Multi-Surface Glides	GL2	+ \$17	
Floor Saver Glides	G12	+ \$17	
Steel Glides (Carpet Only)	G13	+ \$17	

Please use caution when stacking models with casters to prevent frame damage. SitOnIt Seating does not warrant scratched frames.

### 5. Miscellaneous

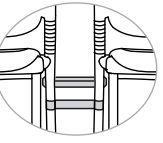
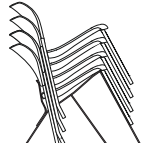
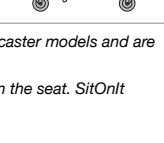
Accessories	Code	Price	
Ganging Bracket for Armless Models	GG9	+ \$30	
Ganging Bracket for Models With Arms	GA9	+ \$30	
Stacking Cart	97-Cart	+ \$399	

Ganging brackets and stacking carts are not intended for use with caster models and are compatible with glides only.

Due to the nature of upholstery, stacking may cause impressions on the seat. SitOnIt Seating does not warrant the effects of stacking on upholstery.

See page page 538 for additional stacking requirements.

## 6. Material

Protection	Code	Price	
<b>Fire Retardancy</b>			
CAL 133, Fabric, Quantities 1-49	133F	+ \$99	
CAL 133, Fabric, Quantities 50+	133F5	+ \$55	
CAL 133, Plastic, Any Quantity	133P	+ \$45	
Shell Color (For Plastic and US)	Code	Price	
Arctic	SC21	+ \$0	
Black	SC1	+ \$0	
Chocolate	SC4	+ \$0	
Lagoon	SC15	+ \$0	
Latte	SC20	+ \$0	
Navy	SC5	+ \$0	
Red	SC19	+ \$0	
Slate	SC8	+ \$0	
Sterling	SC18	+ \$0	
Textile	Code	Price	
<b>Seat Only (For US)</b>			
Fabric/Vinyl Grade 1	FG1/VG1	+ \$0	
COM	COM	+ \$22	
Fabric/Vinyl Grade 2	FG2/VG2	+ \$22	
Fabric/Vinyl Grade 3	FG3/VG3	+ \$45	
Fabric/Vinyl Grade 4	FG4/VG4	+ \$77	
Fabric/Vinyl Grade 5	FG5/VG5	+ \$116	
Fabric/Vinyl Grade 6	FG6/VG6	+ \$159	
Fabric/Vinyl Grade 7	FG7/VG7	+ \$200	
<b>Seat and Back (For UP)</b>			
Fabric/Vinyl Grade 1	FG1/VG1	+ \$0	
COM	COM	+ \$34	
Fabric/Vinyl Grade 2	FG2/VG2	+ \$34	
Fabric/Vinyl Grade 3	FG3/VG3	+ \$74	
Fabric/Vinyl Grade 4	FG4/VG4	+ \$121	
Fabric/Vinyl Grade 5	FG5/VG5	+ \$174	
Fabric/Vinyl Grade 6	FG6/VG6	+ \$235	
Fabric/Vinyl Grade 7	FG7/VG7	+ \$296	

Please reference the Textile Reference Guide for pricing on fabric over grade 7. Additional CAL 133 information can be found on page 10.

## MULTIPURPOSE CHAIR, COUNTER STOOL AND BAR STOOL

## 7. Packaging

Packaging	Code	Price	
Fully Assembled in Carton	AC4	+ \$0	
Fully Assembled Stools in Carton, Individually Packaged	AC1	+ \$20	
Fully Assembled Chairs in Carton, Individually Packaged	AC1	+ \$20	

## SPECIFICATIONS

Model:	971 / 974 Multipurpose Chair	971 S9 24" Counter Stool	971 S2 30" Bar Stool
<b>Dimensions</b>			
Overall Width Armless	20"	19.75"	19.75"
Overall Width With Arms	24.125"	25"	25"
Overall Depth	22"	22.25"	22.25"
Overall Height	33"	38.5"	43.5"
Seat Width	17"	16.75"	16.75"
Seat Depth	17"	18.5"	18.5"
Seat Height	18"	24"	29"
Back Width	20"	19.75"	19.75"
Back Height	15.5"	15.5"	15.5"
<b>Materials</b>			
COM	0.85 yd (US) 1 yd (UP)	0.85 yd (US) 1 yd (UP)	0.85 yd (US) 1 yd (UP)
<b>Stacking</b>			
Max Cart Stacking	12 (Plastic) 10 (US/UP)	N/A	N/A
Max Floor Stacking	5	5	5
<b>Weight and Capacity</b>			
Weight Armless	18 lb	22 lb	23 lb
Weight With Arms	22 lb	26 lb	27 lb
Weight Capacity Warranty	300 lb	300 lb	300 lb

Upholstered seat only (US). Upholstered seat and back (UP).

# Ioniq

GUEST CHAIR

## *Inspire unique.*

There's a specialness that flows through Ioniq. Its form and feeling are fluid—from the way the arms stretch seamlessly out of a sculpted shell to base options that are as varied and versatile as the spaces they occupy. Because when you desire aesthetics that elevate any experience and offer something refreshingly different, there's only one go-to. And that's Ioniq.



*Ioniq Guest*

**EFFECTIVE DECEMBER 1, 2021**

## Featured Model

### **GUEST :: \$790**

Plastic back, upholstered seat, integrated arms, 360-degree swivel, 4-star polished aluminum base. standard multi-surface glides, grade 1 textile

## GUEST CHAIR

### Features

- Breathable back with built-in lumbar support
- Minimalist-designed mechanism with streamlined controls
- Edge-to-edge cushion
- Fully integrated armrests
- Single-piece sculpted shell
- 4-star aluminum base
- 300 lb weight capacity warranty
- Complements Ioniq collaborative; see page 233

#### 1. Frame

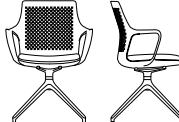
Frame Type	Code	Price	
Guest (4-Star Base)	1152 FT5	\$790	

Seat and Back Style	Code	Price	
Plastic Back With Upholstered Seat Pad	US PB	+ \$0	

Shell Color	Code	Price	
Black	SC1	+ \$0	
White	SC26	+ \$0	

#### 2. Base

Base Type and Material	Code	Price	
4-Star Polished Aluminum	BT5	+ \$0	

Glides	Code	Price	
Standard Multi-Surface Glides	GL1	+ \$0	

#### 3. Mechanism

Mechanism	Code	Price	
Swivel 360-Degree	FHB	+ \$0	

#### 4. Material

Seat Textile	Code	Price
Fabric/Vinyl Grade 1	FG1/VG1	+ \$0
COM	COM	+ \$22
Fabric/Vinyl Grade 2	FG2/VG2	+ \$22
Fabric/Vinyl Grade 3	FG3/VG3	+ \$45
Fabric/Vinyl Grade 4	FG4/VG4	+ \$77
Fabric/Vinyl Grade 5	FG5/VG5	+ \$116
Fabric/Vinyl Grade 6	FG6/VG6	+ \$159
Fabric/Vinyl Grade 7	FG7/VG7	+ \$200
Leather Grade 1	LG1	+ \$140
COL	COL	+ \$200
Leather Grade 2	LG2	+ \$200
Leather Grade 3	LG3	+ \$280

Please reference the *Textile Reference Guide* for pricing on fabric over grade 7 and leather over grade 3.

#### 5. Packaging

Packaging	Code	Price
Back Attached to Seat, Base Separate	UC	+ \$0
Fully Assembled in a Carton	AC	+ \$120

#### SPECIFICATIONS

	1152 FT5 Guest Chair
<b>Dimensions</b>	
Overall Width	28.25"
Overall Depth	28.24"
Overall Height	34.5"
Seat Width	17.5"
Seat Depth	17.38"
Seat Height	18.25"
Back Width	18"
Back Height	17.38"
<b>Materials</b>	
COM	0.75 yd
COL	7 sq ft
<b>Weight and Capacity</b>	
Weight	18.5 lb
Weight Capacity Warranty	300 lb

Chair is widest at the base.

# Ioniq

MULTIPURPOSE CHAIR

## *Inspire unique.*

There's a specialness that flows through Ioniq. Its form and feeling are fluid—from the way the arms stretch seamlessly out of a sculpted shell to base options that are as varied and versatile as the spaces they occupy. Because when you desire aesthetics that elevate any experience and offer something refreshingly different, there's only one go-to. And that's Ioniq.



*Ioniq Side*

**EFFECTIVE DECEMBER 1, 2021**

## Featured Model

### **SIDE :: \$575**

4-leg, chrome finish, plastic back with upholstered seat pad, integrated arms, standard multi-surface glides, grade 1 textile



SIDE CHAIR

Features

- Breathable back with built-in lumbar support
- Edge-to-edge cushion
- Fully integrated armrests
- Single-piece sculpted shell
- 4-leg base
- 300 lb weight capacity warranty
- Complements Ioniq collaborative; see page 86

1. Frame

Frame Type	Code	Price	
4-Leg	1151 FT1	\$575	

Frame Finish	Code	Price	
Chrome	FC15	+ \$0	

Do not stack Ioniq side chairs. Frames are not stackable.

2. Seat and Back

Seat and Back Style	Code	Price	
Plastic Back With Upholstered Seat Pad	US PB	+ \$0	

3. Base

Glides	Code	Price	
Standard Multi-Surface Glides	GL1	+ \$0	

4. Material

Shell Color	Code	Price	
Black	SC1	+ \$0	
White	SC26	+ \$0	
Seat Textile	Code	Price	
Fabric/Vinyl Grade 1	FG1/VG1	+ \$0	
COM	COM	+ \$22	
Fabric/Vinyl Grade 2	FG2/VG2	+ \$22	
Fabric/Vinyl Grade 3	FG3/VG3	+ \$45	
Fabric/Vinyl Grade 4	FG4/VG4	+ \$77	
Fabric/Vinyl Grade 5	FG5/VG5	+ \$116	
Fabric/Vinyl Grade 6	FG6/VG6	+ \$159	
Fabric/Vinyl Grade 7	FG7/VG7	+ \$200	
Leather Grade 1	LG1	+ \$140	
COL	COL	+ \$200	
Leather Grade 2	LG2	+ \$200	
Leather Grade 3	LG3	+ \$280	

Please reference the Textile Reference Guide for pricing on fabric over grade 7.

5. Packaging

Packaging	Code	Price	
Fully Assembled in Carton	AC	+ \$0	

One per carton only.

SPECIFICATIONS

<b>Model:</b>	1151 FT1 4-Leg Multipurpose Chair
<b>Dimensions</b>	
Overall Width	23"
Overall Depth	21.38"
Overall Height	32.5"
Seat Width	17.5"
Seat Depth	17.38"
Seat Height	17.63"
Back Width	18"
Back Height	17.38"
<b>Materials</b>	
COM	0.75 yd
COL	7 sq ft
<b>Weight and Capacity</b>	
Weight	15.5 lb
Weight Capacity Warranty	300 lb

# Kickstand

## STOOL

### *Lean into work.*

Introducing a whole new way to work. There's sitting. There's standing. And now there's perching with Kickstand™. It's an active alternative that provides limitless opportunities for body-benefitting postures, giving you the support you need to lean forward and focus on what's in front of you.



Black

**EFFECTIVE DECEMBER 1, 2021**

### Featured Models

**BLACK :: \$506**

Black finish, upholstered seat and grade 1 fabric

**FOG :: \$525**

Fog finish, upholstered seat and grade 1 fabric

## Features

- Ergo-sculpted, bolstered seat alleviates pressure points while offering soft, flexible edges
- Customize the cushion with access to thousands of fabrics
- Lightweight frame with easy-grip handle means your new posture is always within reach
- Included auto-return cylinder ensures the seat always faces forward
- Streamlined ambidextrous controls make it easy to adjust from either side for various worksurface heights
- Stable, non-slip base with responsive 360-degree pivoting support keeps you energized and productive
- 250 lb weight capacity warranty

### 1. Frame

Frame Type	Code	Price
Sit-to-Stand Stool	1167	\$506

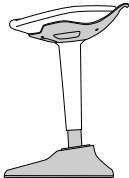

Frame Finish	Code	Price
Black	FC1	+ \$0
Fog	FC13	+ \$19

Frame finish applies to base, column cover and outer seat.

### 2. Seat

Seat Style	Code	Price
Upholstered Seat	US	+ \$0

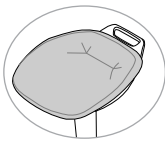

## STOOL

### 3. Base

Stool Kit	Code	Price
Extended Stool Kit	S2	+ \$0

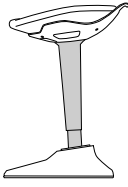

### 4. Material

Seat Textile	Code	Price
Fabric Grade 1	FG1	+ \$0
COM	COM	+ \$22
Fabric Grade 2	FG2	+ \$22
Fabric Grade 3	FG3	+ \$45
Fabric Grade 4	FG4	+ \$77
Fabric Grade 5	FG5	+ \$116
Fabric Grade 6	FG6	+ \$159
Fabric Grade 7	FG7	+ \$200

Please reference the *Textile Reference Guide* for pricing on fabric over grade 7.

To minimize the risk of injury from sliding off Kickstand's forward-tilting seat, SitOnIt Seating does not offer vinyl or leather upholstery options.

### 5. Packaging

Packaging	Code	Price
Knocked Down - Individually Packaged	KD	+ \$0

## SPECIFICATIONS

<b>Model:</b>	1167 Stool
<b>Dimensions</b>	
Overall Width	15.5"
Overall Depth	18.125"
Overall Height	25.75"-35.875"
Seat Width	15.25"
Seat Depth	15.25"
Seat Height	23.5"-33.75"
<b>Materials</b>	
COM	0.75 yd
Weight	17.5 lb
<b>Weight and Capacity</b>	
Weight Capacity Warranty	250 lb

# Lumin

MULTIPURPOSE CHAIR, COUNTER STOOL AND BAR STOOL

## *Light up the room.*

Lumin is an elegant multipurpose stackable chair designed for exceptional support and comfort in corporate and education applications. The contoured seat dissipates pressure points for greater comfort while the perforated back adds contemporary style and comfortable breathability. The Lumin multipurpose stackable chair, counter and bar stools are available in black, silver or chrome frame finish with matching arm pad colors. Refined, sophisticated Lumin will light up the room.



EFFECTIVE DECEMBER 1, 2021

## Featured Models

### **GOOD :: \$315**

4-leg chair, plastic seat and back, armless, standard multi-surface glides

### **BETTER :: \$373**

4-leg chair, upholstered seat, armless, standard multi-surface glides, grade 1 textile

### **BEST :: \$489**

4-leg chair, upholstered seat and back, fixed arms, standard multi-surface glides, grade 1 textile

## MULTIPURPOSE CHAIR, COUNTER STOOL AND BAR STOOL

### Features

- Contemporary design
- 4-leg and wire rod chair, counter and bar stools
- Exceptional support and comfort
- Fully upholstered, upholstered seat or plastic
- 14 plastic shell colors
- Three frame finishes with matching arm pads
- Left or right folding tablet arm in two finishes
- Built-in pull handle
- Clean-out space
- 4-leg plastic model stacks six on the floor; eight on the optional cart
- Wire frame plastic model stacks eight on the floor; 15 on the optional cart
- 300 lb weight capacity warranty
- Complements Lumin light task chair and stool; see page 96

### 1. Frame

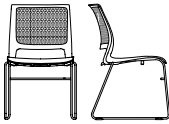
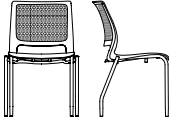
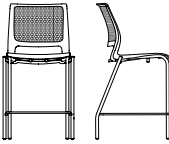
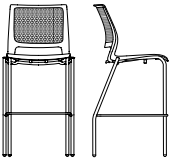
Frame Type	Code	Price	
Wire Rod	1011 FT2	\$292	
4-Leg	1011 FT1	\$315	
24" Counter Stool	1011 FT1 S9	\$465	
30" Bar Stool	1011 FT1 S2	\$465	



Counter (S9) and bar (S2) stools are only available with glides.

### 1. Frame (Cont.)



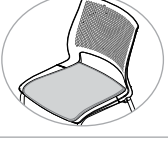

Frame Finish	Code	Price
Black	FC1	+ \$0
Silver (For 4-Leg Frame)	FC2	+ \$0
Chrome (For Wire Rod Frame)	FC15	+ \$0

Arms and glides, if specified, are black for black frames and fog for silver or chrome frames.

### 2. Back

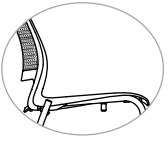
Back and Seat Style	Code	Price	
Plastic Seat	PS	+ \$0	
Upholstered Seat Only	US	+ \$58	
Upholstered Seat and Back	UP	+ \$116	

### 3. Arms

Arm Style	Code	Price	
Armless	A0	+ \$0	
Fixed (For 4-Leg Frame)	A147	+ \$58	
Fixed (For Wire Rod Frame)	A146	+ \$58	
Tablet Arm	Code	Price	
Folding Tablet Arm, Left	RMTL	+ \$156	
Folding Tablet Arm, Right	RMTR	+ \$156	

Tablet arms are not available with stools (S9/S2). Tablet arms are not stackable.

## 4. Base

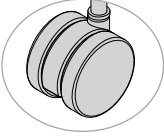
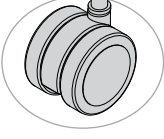
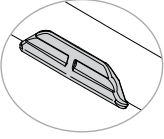
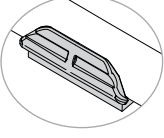
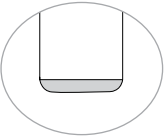
Casters or Glides	Code	Price	
<b>Casters</b>			
Carpet Casters	C13	+ \$40	
Hard Floor and Carpet Casters	C12	+ \$80	
<b>Glides for Wire Rod Frames</b>			
No Glides	G0	+ \$0	
Clear Glides	CGR	+ \$9	
Clear Glides With Felt	CGRF	+ \$22	
<b>Glides for 4-Leg Frames</b>			
Standard Multi-Surface Glides	GL1	+ \$0	
Floor Saver Glides	GL3	+ \$17	
Steel Glides (Carpet Only)	GL4	+ \$17	
Performance Multi-Surface Glides	GL2	+ \$17	

Counter (S9) and bar (S2) stools are only available with glides.

Please use caution when stacking models with casters to prevent frame damage. SitOnIt Seating does not warrant scratched frames.

## 5. Miscellaneous

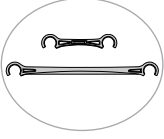
Ganging	Code	Price	
Ganging Bracket for 4-Leg Armless Models	GG10	+ \$30	
Ganging Bracket for 4-Leg Models With Arms	GA10	+ \$30	
Ganging Bracket for Wire Rod Armless Models	GG3	+ \$30	
Ganging Bracket for Wire Rod Models With Arms	GA3	+ \$30	

## MULTIPURPOSE CHAIR, COUNTER STOOL AND BAR STOOL

## 5. Miscellaneous

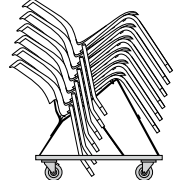
Stacking	Code	Price	
Stacking Cart	1011-CART	+ \$399	

Ganging brackets and stacking carts are not intended for use with caster models and are compatible with glides only. See page 538 for additional stacking requirements.

## 6. Material

Protection	Code	Price	
<b>Fire Retardancy</b>			
CAL 133, Fabric, Quantities 1-49	133F	+ \$64	
CAL 133, Fabric, Quantities 50+	133F5	+ \$20	
CAL 133, Plastic, Any Quantity	133P	+ \$10	



Best

## 6. Material (Cont.)

Shell Color	Code	Price
Apple	SC24	+ \$0
Arctic	SC21	+ \$0
Bisque	SC7	+ \$0
Black	SC1	+ \$0
Chocolate	SC4	+ \$0
Lagoon	SC15	+ \$0
Latte	SC20	+ \$0
Lemon	SC25	+ \$0
Navy	SC5	+ \$0
Pacific	SC22	+ \$0
Red	SC19	+ \$0
Slate	SC8	+ \$0
Sterling	SC18	+ \$0
Tangerine	SC23	+ \$0
Textile	Code	Price
<b>Seat Only (For US)</b>		
Fabric/Vinyl Grade 1	FG1/VG1	+ \$0
COM	COM	+ \$22
Fabric/Vinyl Grade 2	FG2/VG2	+ \$22
Fabric/Vinyl Grade 3	FG3/VG3	+ \$45
Fabric/Vinyl Grade 4	FG4/VG4	+ \$77
Fabric/Vinyl Grade 5	FG5/VG5	+ \$116
Fabric/Vinyl Grade 6	FG6/VG6	+ \$159
Fabric/Vinyl Grade 7	FG7/VG7	+ \$200
<b>Seat and Back (For UP)</b>		
Fabric/Vinyl Grade 1	FG1/VG1	+ \$0
COM	COM	+ \$34
Fabric/Vinyl Grade 2	FG2/VG2	+ \$34
Fabric/Vinyl Grade 3	FG3/VG3	+ \$74
Fabric/Vinyl Grade 4	FG4/VG4	+ \$121
Fabric/Vinyl Grade 5	FG5/VG5	+ \$174
Fabric/Vinyl Grade 6	FG6/VG6	+ \$235
Fabric/Vinyl Grade 7	FG7/VG7	+ \$296

Please reference the Textile Reference Guide for pricing on fabric over grade 7. Additional CAL 133 information can be found on page 10.

## MULTIPURPOSE CHAIR, COUNTER STOOL AND BAR STOOL

## 7. Packaging

Packaging	Code	Price
Fully Assembled in Carton	AC	+ \$0
Fully Assembled in Carton, Individually Packaged	AC1	+ \$20

## CHAIR SPECIFICATIONS

Model:	1011 FT1 4-Leg Multipurpose Chair	1011 FT2 Wire Rod Multipurpose Chair
<b>Dimensions</b>		
Overall Width Armless	21.2"	21.2"
Overall Width With Arms	22.2"	22.2"
Overall Depth	21.6"	21.6"
Overall Height	33.4"	33.4"
Seat Width	18.5"	18.5"
Seat Depth	18.2"	18.2"
Seat Height	17.9"	17.9"
Back Width	18.2"	18.2"
Back Height	17.5"	17.5"
<b>Materials</b>		
COM	0.85 yd (US) 1 yd (UP)	0.85 yd (US) 1 yd (UP)
<b>Stacking</b>		
Max Cart Stacking	8 (PS), 6 (US/UP)	15 (PS), 6 (US/UP)
Max Floor Stacking	6 (PS), 4 (US/UP)	8 (PS), 4 (US/UP)
<b>Weight and Capacity</b>		
Weight Armless	12.3 lb	15.8 lb
Weight With Arms	13.8 lb	17.3 lb
Weight Capacity Warranty	300 lb	300 lb

Upholstered seat only (US). Upholstered seat and back (UP).

## STOOL SPECIFICATIONS

Model:	1011 S9 24" Counter Stool	1011 S2 30" Bar Stool
<b>Dimensions</b>		
Overall Width Armless	21.3"	21.3"
Overall Width With Arms	26.8"	26.8"
Overall Depth	22.1"	22.1"
Overall Height	40"	45.1"
Seat Width	19"	19"
Seat Depth	18.7"	18.7"
Seat Height	24.25"	29.5"
Back Width	18.3"	18.3"
Back Height	16.7"	16.7"
<b>Materials</b>		
COM	0.85 yd (US) 1 yd (UP)	0.85 yd (US) 1 yd (UP)
<b>Weight and Capacity</b>		
Weight Armless	17 lb	20.3 lb
Weight With Arms	18.7 lb	21.9 lb
Weight Capacity Warranty	300 lb	300 lb

*Upholstered seat only (US). Upholstered seat and back (UP).*



Better



# Mika

## MULTIPURPOSE CHAIR AND BAR STOOL

### *Design above.*

Mika sits above most others in its class—and not just because it was a multi-award winner. Mika is elevated. Upholstered or non-upholstered, it reaches new heights in what a molded shell chair can be. From top to bottom, the design flows. Back and forth, the design rocks with 15 degrees of flex. Up and up, the design pushes an upholstered seat farther than ever before. And in the end, you arrive at a place of sit-ability and stack-ability hard to find in something that looks this good.



reddot winner 2021



Best

EFFECTIVE DECEMBER 1, 2021

### Featured Models

#### **GOOD :: \$340**

4-leg, all plastic, armless, standard multi-surface glides

#### **BETTER :: \$416**

Wire rod, upholstered seat, armless, no glides, grade 1 textile



#### **BEST :: \$439**

4-leg, upholstered seat, armless, standard multi-surface glides, grade 1 textile

## Features

- Designed by ITO Design
- Single-piece shell with 15 degrees of backrest flex
- Sculpted shell provides a natural cradle
- Optional  $\frac{2}{3}$  upholstered seat available in 15,000+ textiles
- Base options include 4-leg, wire rod and wire rod bar stool
- Three neutral shell colors
- White, black, fog and chrome frame finishes
- Wire rod model stacks up to 30 chairs on a cart
- Upholstered 4-leg model stacks up to nine chairs on the floor
- 300 lb weight capacity warranty

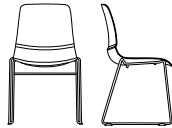
### 1. Frame

Frame Type	Code	Price	
4-Leg	1101 FT1	\$340	
Wire Rod	1101 FT2	\$317	
30" Wire Rod Bar Stool	1101 FT2 S2	\$467	
Frame Finish	Code	Price	
<b>For 4-Leg Frame (FT1)</b>			
Black	FC1	+ \$0	
Fog	FC13	+ \$0	
White	FC12	+ \$0	
<b>For Wire Rod Frame (FT2)</b>			
Black	FC1	+ \$0	
Chrome	FC15	+ \$0	

## MULTIPURPOSE CHAIR AND BAR STOOL

### 2. Seat

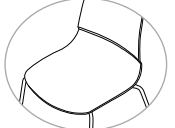
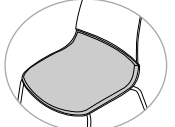
Seat Style	Code	Price	
Plastic Seat	PS	+ \$0	
Upholstered Seat ( $\frac{2}{3}$ Upholstered Wrap)	US	+ \$99	

### 3. Arms

Arm Style	Code	Price	
Armless	AR0	+ \$0	

### 4. Base

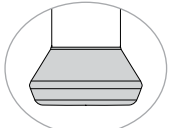
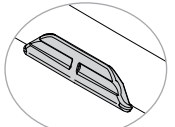
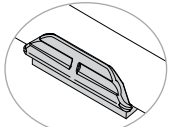
Glides	Code	Price	
<b>For 4-Leg Frame (FT1)</b>			
Standard Multi-Surface Glides	GL1	+ \$0	
<b>For Wire Rod Frame (FT2)</b>			
No Glides	G0	+ \$0	
Clear Glides	CGR	+ \$9	
Clear Glides With Felt	CGRF	+ \$22	

## 5. Miscellaneous

Accessories	Code	Price	
Stacking Cart	CART	+\$399	

Please use caution when stacking to prevent frame damage. SitOnIt Seating does not warrant scratched frames.

Wire rod bar stools (S2) do not stack on cart. See page 538 for additional stacking requirements.

## 6. Material

Protection	Code	Price	
<b>Fire Retardancy</b>			
CAL 133, Fabric, Quantities 1-49	133F	+\$64	
CAL 133, Fabric, Quantities 50+	133F5	+\$20	
CAL 133, Plastic, Any Quantity	133P	+\$10	
Shell Color	Code	Price	
Black	SC1	+\$0	
White	SC26	+\$0	
Fog	SC27	+\$0	
Seat Textile (For US)	Code	Price	
Fabric/Vinyl Grade 1	FG1/VG1	+\$0	
COM	COM	+\$22	
Fabric/Vinyl Grade 2	FG2/VG2	+\$22	
Fabric/Vinyl Grade 3	FG3/VG3	+\$45	
Fabric/Vinyl Grade 4	FG4/VG4	+\$77	
Fabric/Vinyl Grade 5	FG5/VG5	+\$116	
Fabric/Vinyl Grade 6	FG6/VG6	+\$159	
Fabric/Vinyl Grade 7	FG7/VG7	+\$200	

Please reference the Textile Reference Guide for pricing on fabric over grade 7. Additional CAL 133 information can be found on page 10.

## 7. Packaging

Packaging	Code	Price	
Fully Assembled in Carton	AC	+\$0	
Fully Assembled in Carton, Individually Packaged	AC1	+\$20	

## MULTIPURPOSE CHAIR AND BAR STOOL

### SPECIFICATIONS

Model:	1101 FT1 4-Leg Chair	1101 FT2 Wire Rod Chair	1101 FT2 S2 Wire Rod Bar Stool
<b>Dimensions</b>			
Overall Width	22.75"	19.65"	19.88"
Overall Depth	19.5"	19.5"	22.9"
Overall Height	32.15"	32.4"	45.75"
Seat Width	17.5"	17.5"	17.5"
Seat Depth	16.75"	16.75"	16.75"
Seat Height	18.5"	18.5"	30.25"
Back Width	16.25"	16.25"	16.25"
Back Height	16.25"	16.25"	16.25"
<b>Materials</b>			
COM	0.85 yd	0.85 yd	0.85 yd
<b>Stacking</b>			
Max Floor Stacking	3 (PS) 9 (US)	3 (PS) 6 (US)	3 (PS) 3 (US)
Max Cart Stacking	12 (PS) 12 (US)	30 (PS) 12 (US)	N/A
<b>Weight and Capacity</b>			
Weight	15 lb	14.5 lb	19.5"
Weight Capacity Warranty	300 lb	300 lb	300 lb

Plastic seat (PS). Upholstered seat (US).



Good

# Movi

## NESTER CHAIR

### *Lean back. Nest easy.*

Meet the last nester you'll ever need. Whether you're setting up, breaking down or making space for spontaneous collaboration, today's modern workplace calls for high-design seating solutions that can keep up with it all.

Enter Movi: our ultra-lightweight nester with a slim, modern frame and extra flexibility built right in for long-range comfort all day long.



EFFECTIVE DECEMBER 1, 2021

### Featured Models

#### **GOOD :: \$634**

Mesh back, upholstered seat, black frame and base, armless, casters, grade 1 textile

#### **BETTER :: \$664**

Mesh back, upholstered seat, black frame and base, fixed arms, casters, grade 1 textile

#### **BEST :: \$699**

Mesh back, upholstered seat, fog frame and base, fixed arms, casters, grade 1 textile

## NESTER CHAIR

### Features

- Compact, 22.75" of depth
- Nests compactly to save space (53% to be exact)
- Flexes at the hip 14-degrees for enhanced comfort
- Caster design and flip-up seat provide easy nesting
- Movement-friendly back & arm support
- Clean-out space for easy maintenance
- Bleach-cleanable mesh back (10:1)
- 12 mesh colors
- Three base frame and caster colors
- Three back frame and arm colors
- Available as an armless option
- Carpet, hard floor and carpet casters available
- 300 lb weight capacity warranty
- Complements Movi light task chair and stool; see page 103



Best

### 1. Frame

Frame Type	Code	Price	
Nesting	1061 FT4 MB	\$664	

Back Frame Finish	Code	Price	
Black	SC1	+ \$0	
Fog	SC27	+ \$35	
White	SC26	+ \$35	

### 2. Arms

Arm Style	Code	Price	
Armless	AR0	-\$30	

Fixed Loop Arms	AR1	+ \$0	
-----------------	-----	-------	---

Arms (AR1) will match back frame color.

### 3. Base

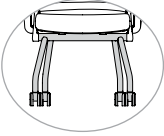
Base Frame and Caster Color	Code	Price	
Black Base With Black Casters	FC1	+ \$0	
Silver Base With Fog Casters	FC2	+ \$0	
White Base With Fog/White Casters	FC12	+ \$0	

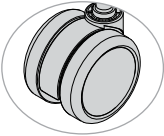
Casters or Glides	Code	Price	
<b>Casters</b>			
Carpet Casters	CS5	+ \$0	
Hard Floor and Carpet Casters	CS6	+ \$40	

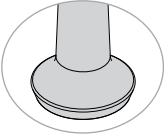
<b>Glides</b>			
Bell Glides (Black)	CS20	+\$30	

## 4. Material

Protection	Code	Price	
<b>Fire Retardancy</b>			
CAL 133, Fabric, Quantities 1-49	133F	+ \$99	
CAL 133, Fabric, Quantities 50+	133F5	+ \$55	
Mesh Color	Code	Price	
Apple	MC31	+ \$0	
Aqua	MC30	+ \$0	
Desert	MC22	+ \$0	
Electric Blue	MC24	+ \$0	
Fire	MC25	+ \$0	
Fog	MC23	+ \$0	
Grape	MC26	+ \$0	
Lemon	MC27	+ \$0	
Nickel	MC21	+ \$0	
Ocean	MC29	+ \$0	
Onyx	MC20	+ \$0	
Tangerine	MC28	+ \$0	
Seat Textile	Code	Price	
Fabric/Vinyl Grade 1	FG1/VG1	+ \$0	
COM	COM	+ \$22	
Fabric/Vinyl Grade 2	FG2/VG2	+ \$22	
Fabric/Vinyl Grade 3	FG3/VG3	+ \$45	
Fabric/Vinyl Grade 4	FG4/VG4	+ \$77	
Fabric/Vinyl Grade 5	FG5/VG5	+ \$116	
Fabric/Vinyl Grade 6	FG6/VG6	+ \$159	
Fabric/Vinyl Grade 7	FG7/VG7	+ \$200	

Please reference the *Textile Reference Guide* for pricing on fabric over grade 7. Additional CAL 133 information can be found on page 10.

## 5. Packaging

Packaging	Code	Price	
Fully Assembled in Carton	AC	+ \$0	
Fully Assembled in Carton, Individually Packaged	AC1	+ \$20	

## NESTER CHAIR

### SPECIFICATIONS

Model:	1061 FT4 Nester Chair
<b>Dimensions</b>	
Overall Width With Arms	23"
Overall Width Armless	21"
Overall Depth	22.75"
Overall Height	34.62"
Seat Width	19"
Seat Depth	17"
Seat Height	18"
Back Width	18"
Back Height	18"
<b>Materials</b>	
COM	0.75 yd
<b>Weight and Capacity</b>	
Weight With Arms	20 lb
Weight Armless	19 lb
Weight Capacity Warranty	300 lb

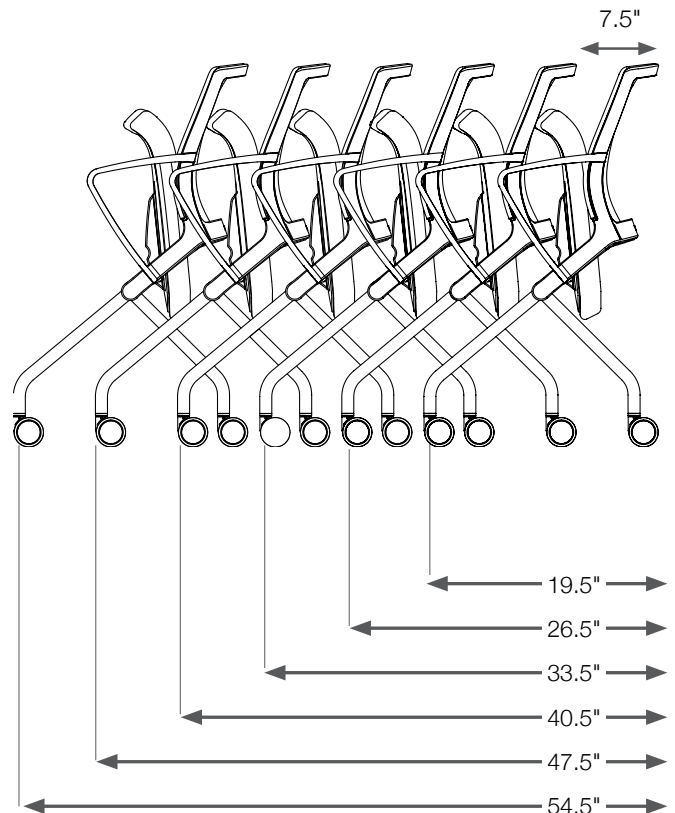

# OnCall

## MULTIPURPOSE CHAIR AND BAR STOOL

### *High performance, low maintenance.*

Practical, solid wire frame design and stackability make OnCall™ ideal for multipurpose use. It's a value-priced solution for meeting rooms and break areas as well as labs and educational environments. The plastic model offers value while upholstered models ensure a more comfortable sit. A half-circle back cutout serves as a handle to move the side chair or stool anywhere.



Good

**EFFECTIVE DECEMBER 1, 2021**

### Featured Models

**GOOD :: \$219**

Wire rod chair, all plastic, armless

**BETTER :: \$277**

Wire rod chair, upholstered seat and plastic back, armless, grade 1 textile



**BEST :: \$393**

Wire rod chair, upholstered seat and back, fixed arms, grade 1 textile

### Features

- Fully upholstered, upholstered seat or plastic
- Three plastic colors
- Black or chrome frame
- Chair stacks eight on the floor, 20-25 on the optional cart; bar stool stacks four on the floor
- Built-in pull handle
- Wall-saver frame design
- 250 lb weight capacity warranty
- Complements OnCall light task chair and stool; see page 121

#### 1. Back

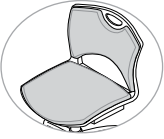
Back and Seat Style	Code	Price	
Plastic	No Code	\$219	
Upholstered Seat Only	US	\$277	
Upholstered Seat and Back	UP	\$335	

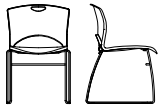
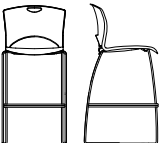

#### 2. Frame

Frame Type	Code	Price	
Wire Rod Side Chair	90	+ \$0	
30" Wire Rod Bar Stool	90 S2	+ \$150	

#### 2. Frame (Cont.)

Frame Finish	Code	Price	
Black	SB	+ \$0	
Chrome	SC	+ \$0	

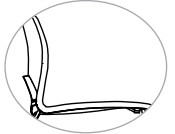
#### 3. Arms

Arm Style	Code	Price	
Armless	A0	+ \$0	
Fixed Cantilever	A37	+ \$58	

*Fixed cantilever arms (A37) are not available on the bar stool (90 S2).*

#### 4. Base

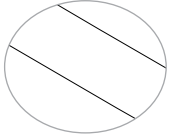
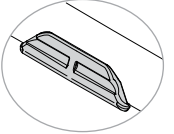
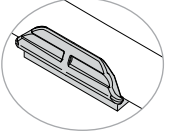
Glides	Code	Price	
No Glides	N	+ \$0	
Clear Glides	CG	+ \$9	
Clear Glides With Felt	CGF	+ \$27	

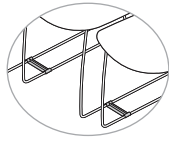
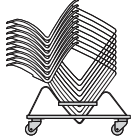

## 5. Miscellaneous

Accessories	Code	Price	
Ganging Bracket for Armless Models	GG3	+ \$12	
Ganging Bracket for Models With Arms	GA3	+ \$12	
Stacking Cart	Cart	+ \$399	

Ganging brackets and stacking carts are not intended for use with wire rod bar stool (S2) models and are compatible with side chair only.

See page 538 for additional stacking requirements.

## 6. Material

Protection	Code	Price	
<b>Fire Retardancy</b>			
CAL 133, Fabric, Quantities 1-49	133F	+ \$99	
CAL 133, Fabric, Quantities 50+	133F5	+ \$55	
CAL 133, Plastic, Any Quantity	133P	+ \$45	
Shell Color	Code	Price	
Black	SC1	+ \$0	
Navy	SC5	+ \$0	
Slate	SC8	+ \$0	
Textile	Code	Price	
<b>Seat Only (For US)</b>			
Fabric/Vinyl Grade 1	FG1/VG1	+ \$0	
COM	COM	+ \$22	
Fabric/Vinyl Grade 2	FG2/VG2	+ \$22	
Fabric/Vinyl Grade 3	FG3/VG3	+ \$45	
Fabric/Vinyl Grade 4	FG4/VG4	+ \$77	
Fabric/Vinyl Grade 5	FG5/VG5	+ \$116	
Fabric/Vinyl Grade 6	FG6/VG6	+ \$159	
Fabric/Vinyl Grade 7	FG7/VG7	+ \$200	

## MULTIPURPOSE CHAIR AND BAR STOOL

### 6. Material

Textile (Cont.)	Code	Price	
<b>Seat and Back (For UP)</b>			
Fabric/Vinyl Grade 1	FG1/VG1	+ \$0	
COM	COM	+ \$34	
Fabric/Vinyl Grade 2	FG2/VG2	+ \$34	
Fabric/Vinyl Grade 3	FG3/VG3	+ \$74	
Fabric/Vinyl Grade 4	FG4/VG4	+ \$121	
Fabric/Vinyl Grade 5	FG5/VG5	+ \$174	
Fabric/Vinyl Grade 6	FG6/VG6	+ \$235	
Fabric/Vinyl Grade 7	FG7/VG7	+ \$296	

Please reference the *Textile Reference Guide* for pricing on fabric over grade 7. Additional CAL 133 information can be found on page 10.



Better

## 7. Packaging

Packaging	Code	Price
Fully Assembled Chairs in Carton	AC4	+ \$0
Fully Assembled Stools in Carton	AC4	+ \$0
Fully Assembled Chairs in Carton, Individually Packaged	AC1	+ \$20

An additional charge will apply for each additional chair in the AC1 packaging.

## SPECIFICATIONS

Model:	90 Wire Rod Multipurpose Chair	90 S2 30" Wire Rod Bar Stool
<b>Dimensions</b>		
Overall Width Armless	20"	20"
Overall Width With Arms	24.5"	24.5"
Overall Depth	22.5"	23"
Overall Height	31"	43.5"
Seat Width	18"	18"
Seat Depth	17.5"	17.5"
Seat Height	17.5"	29.5"
Back Width	19.5"	19.5"
Back Height	15"	15"
<b>Materials</b>		
COM	0.8 yd (US) 0.85 yd (UP)	0.8 yd (US) 0.85 yd (UP)
<b>Stacking</b>		
Max Cart Stacking Armless	25 (Plastic)	N/A
Max Cart Stacking With Arms	20 (Plastic)	N/A
Max Floor Stacking Armless	8	4
Max Floor Stacking With Arms	8	N/A
<b>Weight and Capacity</b>		
Weight Armless	11.4 lb (Plastic) 12.4 lb (US)	21.2 lb (Plastic) 22.2 lb (US)
Weight With Arms	14.2 lb (Plastic) 15.2 lb (US)	N/A
Weight Capacity Warranty	250 lb	250 lb

Upholstered seat only (US). Upholstered seat and back (UP).



# Orbix

## MULTIPURPOSE CHAIR AND BAR STOOL

### *Everything you need (and more).*

More design in a stacker. More comfort in a sit. More models to match the needs of any space. The robust build of Orbix® features an ultra-supportive and extra-wide backrest with hundreds of diamond-cut perforations for unmatched breathability and the comfort to breeze through safe and distanced get-togethers. It sets up quickly, stacks up easily, and stores away conveniently.



Good

**EFFECTIVE DECEMBER 1, 2021**

### Featured Models

#### **GOOD :: \$203**

Multipurpose chair, plastic seat and back, armless, no glides

#### **BETTER :: \$270**

Multipurpose chair, upholstered seat, plastic back, armless, clear glides, grade 1 textile



#### **BEST :: \$341**

Multipurpose chair, upholstered seat, plastic back, fixed arms, clear glides with felt, grade 1 textile

### Features

- Consistent, cohesive look with a broad statement of line offers options to fit any space
- Upscale stacking chair with bold lines and striking detail
- Ultra-supportive, extra-wide backrest provides lasting comfort
- Hundreds of diamond-cut perforations offer unmatched breathability and visual transparency
- Integrated clean-out makes it easy to wipe down, set up, stack and store away
- Collection options include wire rod, bar stool, light task chair and stool; see page 125 for Orbix light task
- Plastic wire rod stacks 6 on the floor (25 on a cart); plastic bar stool stacks 6 on the floor
- Black or chrome frame finish and 14 shell colors coordinate with optional arm pads and upholstered seat

### 1. Frame

Frame Type	Code	Price	
Wire Rod Chair	1131 FT2	\$203	
30" Bar Stool	1131 FT2 S2	\$353	
Frame Type	Code	Price	
Black	FC1	+\$0	
Chrome	FC15	+\$0	

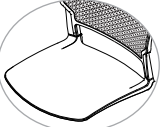
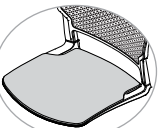
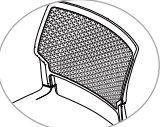

### 2. Seat and Back

Seat Style	Code	Price	
Plastic	PS	+\$0	
Upholstered Seat	US	+\$58	
Back Style	Code	Price	
Plastic	PB	+\$0	

*Do not stack upholstered chairs.*



### 3. Arms

Arm Style	Code	Price	
Armless	AR0	+\$0	
Fixed	AR1	+\$58	

Available on wire rod chairs only.

### 4. Base

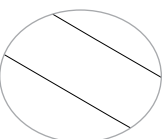
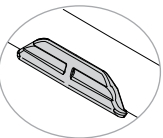
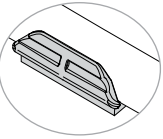
Glides	Code	Price	
No Glides	G0	+\$0	
Clear Glides	CGR	+\$9	
Clear Glides With Felt	CGRF	+\$22	

### 5. Miscellaneous

Accessories	Code	Price	
Ganging Bracket for Armless Models	GG	+\$12	
Ganging Bracket for Models With Arms	GA	+\$12	
Stacking Cart	CART	+\$399	

See page 538 for additional stacking requirements.

### 6. Material

Shell Color	Code	Price	
Apple	SC24	+\$0	
Arctic	SC21	+\$0	
Bisque	SC7	+\$0	
Black	SC1	+\$0	
Chocolate	SC4	+\$0	
Latte	SC20	+\$0	
Lagoon	SC15	+\$0	
Lemon	SC25	+\$0	
Navy	SC5	+\$0	
Pacific	SC22	+\$0	
Red	SC19	+\$0	
Slate	SC8	+\$0	
Sterling	SC18	+\$0	
Tangerine	SC23	+\$0	

Seat Textile	Code	Price	
Fabric/Vinyl Grade 1	FG1/VG1	+\$0	
COM	COM	+\$22	
Fabric/Vinyl Grade 2	FG2/VG2	+\$22	
Fabric/Vinyl Grade 3	FG3/VG3	+\$45	
Fabric/Vinyl Grade 4	FG4/VG4	+\$77	
Fabric/Vinyl Grade 5	FG5/VG5	+\$116	
Fabric/Vinyl Grade 6	FG6/VG6	+\$159	
Fabric/Vinyl Grade 7	FG7/VG7	+\$200	

### 7. Packaging

Packaging	Code	Price	
Fully Assembled in Carton	AC	+\$0	
Fully Assembled in Carton, Individually Packaged	AC1	+\$20	

## SPECIFICATIONS

	1131 FT2 Wire Rod Chair	1131 FT2 S2 Bar Stool
<b>Dimensions</b>		
Overall Width Armless	20"	20"
Overall Width With Arms	24.75"	N/A
Overall Depth	21.75"	22.5"
Overall Height	33.25"	45.5"
Seat Width	18.25"	18.25"
Seat Depth	17.25"	17.25"
Seat Height	18"	30"
Back Width	19.75"	19.75"
Back Height	17.5"	17.5"
<b>Materials</b>		
COM	0.75 yd	0.75 yd
<b>Stacking</b>		
Max Cart Stacking	25 (PS)	N/A
Max Floor Stacking	6 (PS)	6 (PS)
<b>Weight and Capacity</b>		
Weight Armless	13 lb (PS) 14 lb (US)	21 lb (PS) 22 lb (US)
Weight With Arms	16 lb (PS) 17 lb (US)	N/A
Weight Capacity Warranty	300 lb	300 lb

*Plastic seat (PS). Upholstered seat (US).*



Better

# Qwiz

## NESTER CHAIR

### *Nest brilliantly.*

From classrooms to training rooms, the need to get in groups can pop up without warning – and Qwiz® is the perfect answer. It's a smart, fun and versatile nester that makes coming together for collaboration or leaving the room with inspiration quick, easy and comfortable.



EFFECTIVE DECEMBER 1, 2021

### Featured Models

#### **PLASTIC :: \$442**

Plastic seat and back, armless, black shell and frame, carpet casters

#### **MESH :: \$543**

Upholstered seat, mesh back, white frame, carpet casters, grade 1 textile

#### **UPHOLSTERED :: \$573**

Upholstered seat and back, fog frame, fixed arms, carpet casters, grade 1 textile

## Features

- Caster design and flip-up seat for high-density nesting
- Perforated seat and back for breathability
- Three shell and frame colors
- 12 bleach-cleanable mesh back colors
- Upholstered seat or fully upholstered
- Interlocking system for easy ganging
- Available as an armless option
- Performance casters and standard multi-surface glides available
- 300 lb weight capacity warranty

### 1. Frame

Frame Type	Code	Price	
Nesting	1141 FT4	\$472	
Shell and Frame Finish	Code	Price	
Black	SC1	+ \$0	
Fog	SC27	+ \$35	
White	SC26	+ \$35	

### 2. Seat

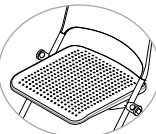
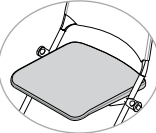
Seat Style	Code	Price	
Plastic Seat	PS	+ \$0	
Upholstered Seat	US	+ \$33	

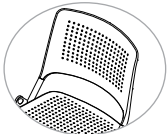
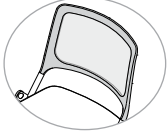
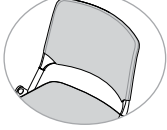

## NESTER CHAIR

### 3. Back

Back Style	Code	Price	
Plastic Back	PB	+ \$0	
Mesh Back	MB	+ \$33	
Upholstered Back	UB	+ \$33	

*Upholstered back (UB) is only available with upholstered seat (US).*

### 4. Arms

Arm Style	Code	Price	
Armless	AR0	- \$30	
Fixed	AR1	+ \$0	

*Arm caps will match shell color.*

### 5. Base

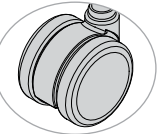
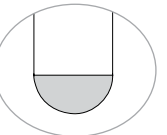
Casters or Glides	Code	Price	
<b>Casters</b>			
Carpet Casters	CS5	+ \$0	
Hard Floor and Carpet Casters	CS6	+ \$40	
<b>Glides</b>			
Standard Multi-Surface Glides	GL1	+ \$30	

*Casters, glides and interlock system are black for black shell and frame (SC1) and fog for both fog (SC27) or white (SC26) shells and frames.*



**6. Material**

Mesh Color (For MB)	Code	Price	
Apple	MC31	+ \$0	
Aqua	MC30	+ \$0	
Desert	MC22	+ \$0	
Electric Blue	MC24	+ \$0	
Fire	MC25	+ \$0	
Fog	MC23	+ \$0	
Grape	MC26	+ \$0	
Lemon	MC27	+ \$0	
Nickel	MC21	+ \$0	
Ocean	MC29	+ \$0	
Onyx	MC20	+ \$0	
Tangerine	MC28	+ \$0	
Protection	Code	Price	
<b>Fire Retardancy</b>			
CAL 133, Fabric, Quantities 1-49	133F	+ \$64	
CAL 133, Fabric, Quantities 50+	133F5	+ \$20	
CAL 133, Plastic, Any Quantity	133P	+ \$10	

Additional CAL 133 information can be found on page 10.

**NESTER CHAIR**

**6. Material (Cont.)**

Textile	Code	Price	
<b>Seat Only (For US)</b>			
Fabric/Vinyl Grade 1	FG1/VG1	+ \$0	
COM	COM	+ \$22	
Fabric/Vinyl Grade 2	FG2/VG2	+ \$22	
Fabric/Vinyl Grade 3	FG3/VG3	+ \$45	
Fabric/Vinyl Grade 4	FG4/VG4	+ \$77	
Fabric/Vinyl Grade 5	FG5/VG5	+ \$116	
Fabric/Vinyl Grade 6	FG6/VG6	+ \$159	
Fabric/Vinyl Grade 7	FG7/VG7	+ \$200	
<b>Seat and Back (For UB)</b>			
Fabric/Vinyl Grade 1	FG1/VG1	+ \$0	
COM	COM	+ \$34	
Fabric/Vinyl Grade 2	FG2/VG2	+ \$34	
Fabric/Vinyl Grade 3	FG3/VG3	+ \$74	
Fabric/Vinyl Grade 4	FG4/VG4	+ \$121	
Fabric/Vinyl Grade 5	FG5/VG5	+ \$174	
Fabric/Vinyl Grade 6	FG6/VG6	+ \$235	
Fabric/Vinyl Grade 7	FG7/VG7	+ \$296	

Please reference the Textile Reference Guide for pricing on fabric over grade 7.

Due to the nature of vinyl upholstery, nesting may cause impressions on the seat. SitOnIt Seating does not warrant the effects of nesting on vinyl upholstery.



Plastic



Upholstered

**7. Packaging**

Packaging	Code	Price
Fully Assembled in Carton	AC	+ \$0
Fully Assembled in Carton, Individually Packaged	AC1	+ \$20

**SPECIFICATIONS**

Model:	1141 FT4 Nester
<b>Dimensions</b>	
Overall Width With Arms	22"
Overall Width Armless	22"
Overall Depth	22.5"
Overall Height	32"
Seat Width	16.4"
Seat Depth	17"
Seat Height	17.75" (PS) 18" (US/UB)
Back Width	18.5"
Back Height	15"
Arm Height	25.5"
<b>Materials</b>	
COM	0.75 yd (US) 1 yd (US/UB)
<b>Weight and Capacity</b>	
Weight With Arms	15 lb
Weight Armless	13 lb
Weight Capacity Warranty	300 lb

*Plastic seat (PS). Upholstered seat only (US). Upholstered seat and back (US/UB).*

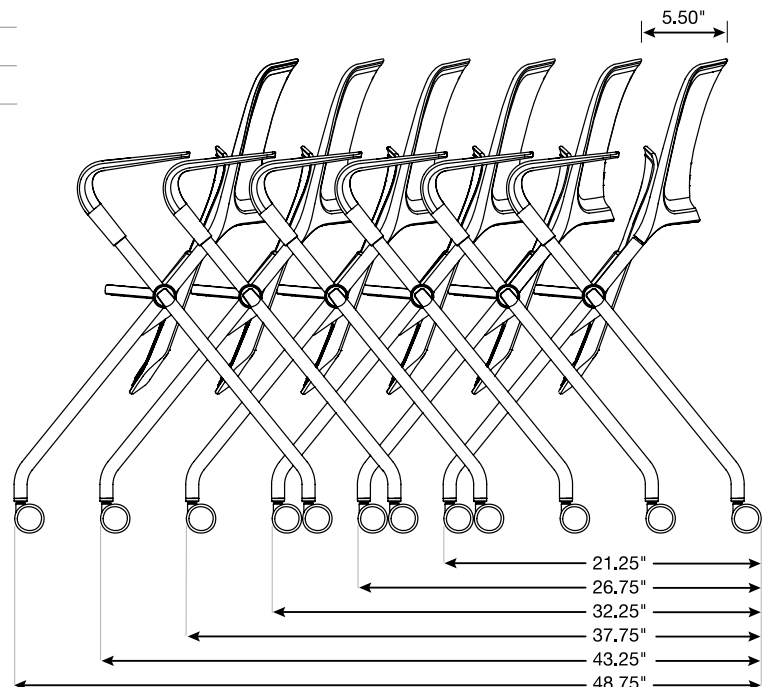

# Relay

## MULTIPURPOSE CHAIR

### *Durable and adaptable to the finish.*

Great to look at, Relay provides lasting comfort in a stylish design that makes an appealing multipurpose seating option for meeting, training, conference and break rooms. The seat and back are molded from high-impact thermoplastic for lasting durability and comfort. Add the optional upholstered seat and back for a more sophisticated, inviting look and added comfort. Relay side chairs are available in black or silver frame with a caster option.



EFFECTIVE DECEMBER 1, 2021

### Featured Models

#### **GOOD :: \$334**

All plastic, armless, standard multi-surface glides

#### **BETTER :: \$392**

Plastic back, upholstered seat, armless, standard multi-surface glides, grade 1 textile



#### **BEST :: \$548**

Upholstered seat and back, fixed cantilever arms, casters, grade 1 textile

## Features

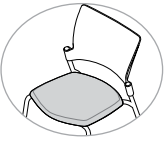

- Structurally reinforced and durable back
- High-impact polypropylene
- Fully upholstered, upholstered seat or plastic
- Nine plastic colors
- 4-leg frame
- Armless or with fixed cantilever arms
- Stacks 5 on the floor, 5 on the optional cart
- Black or silver frame
- Wall-saver frame design
- 250 lb weight capacity warranty
- Complements Relay light task chair and stool; see page 139

### 1. Back

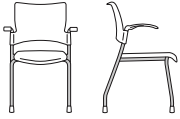
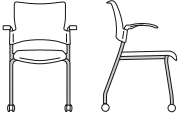

Back and Seat Style	Code	Price	
Plastic	No Code	\$334	
Upholstered Seat Only	US	\$392	
Upholstered Seat and Back	UP	\$450	

## MULTIPURPOSE CHAIR

### 2. Frame

Frame Type and Finish	Code	Price	
Black, 4-Leg	94FB	+ \$0	
Silver, 4-Leg	94FS	+ \$0	
Black, 4-Leg With Black Carpet Casters	94FCB	+ \$40	
Silver, 4-Leg With Black Carpet Casters	94FCS	+ \$40	

### 3. Arms

Arm Style	Code	Price	
Armless	A0	+ \$0	
Fixed Cantilever	A60	+ \$58	

### 4. Base

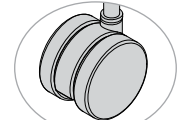
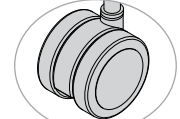
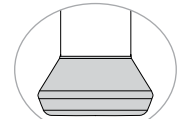
Casters or Glides	Code	Price	
<b>Casters (For 94FCB / 94FCS)</b>			
Carpet Casters	C13	+ \$0	
Hard Floor and Carpet Casters	C12	+ \$40	
<b>Glides (For 94FB / 94FS)</b>			
Standard Multi-Surface Glides	G9	+ \$0	

Please use caution when stacking models with casters to prevent frame damage. SitOnIt Seating does not warrant scratched frames.

## 5. Miscellaneous

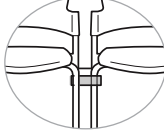
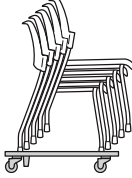
Accessories	Code	Price	
Ganging Bracket for Armless Models	GG2	+ \$28	
Ganging Bracket for Models With Arms	GA2	+ \$28	
Stacking Cart	14-Cart	+ \$324	

Ganging brackets and stacking carts are not intended for use with caster models and are compatible with glides only. See page 538 for additional stacking requirements.

Due to the nature of upholstery, stacking may cause impressions on the seat. SitOnIt Seating does not warrant the effects of stacking on upholstery.

## 6. Material

Protection	Code	Price	
<b>Fire Retardancy</b>			
CAL 133, Fabric, Quantities 1-49	133F	+ \$99	
CAL 133, Fabric, Quantities 50+	133F5	+ \$55	
CAL 133, Plastic, Any Quantity	133P	+ \$45	
Shell Color	Code	Price	
Arctic	SC21	+ \$0	
Black	SC1	+ \$0	
Chocolate	SC4	+ \$0	
Lagoon	SC15	+ \$0	
Latte	SC20	+ \$0	
Navy	SC5	+ \$0	
Red	SC19	+ \$0	
Slate	SC8	+ \$0	
Sterling	SC18	+ \$0	
Textile	Code	Price	
<b>Seat Only (US)</b>			
Fabric/Vinyl Grade 1	FG1/VG1	+ \$0	
COM	COM	+ \$22	
Fabric/Vinyl Grade 2	FG2/VG2	+ \$22	
Fabric/Vinyl Grade 3	FG3/VG3	+ \$45	
Fabric/Vinyl Grade 4	FG4/VG4	+ \$77	
Fabric/Vinyl Grade 5	FG5/VG5	+ \$116	
Fabric/Vinyl Grade 6	FG6/VG6	+ \$159	
Fabric/Vinyl Grade 7	FG7/VG7	+ \$200	

## MULTIPURPOSE CHAIR

### 6. Material (Cont.)

Textile	Code	Price	
<b>Seat and Back (UP)</b>			
Fabric/Vinyl Grade 1	FG1/VG1	+ \$0	
COM	COM	+ \$34	
Fabric/Vinyl Grade 2	FG2/VG2	+ \$34	
Fabric/Vinyl Grade 3	FG3/VG3	+ \$74	
Fabric/Vinyl Grade 4	FG4/VG4	+ \$121	
Fabric/Vinyl Grade 5	FG5/VG5	+ \$174	
Fabric/Vinyl Grade 6	FG6/VG6	+ \$235	
Fabric/Vinyl Grade 7	FG7/VG7	+ \$296	

Please reference the *Textile Reference Guide* for pricing on fabric over grade 7.

## 7. Packaging

Packaging	Code	Price	
Fully Assembled in Carton	AC4	+ \$0	
Individually Packaged	AC1	+ \$20	

## SPECIFICATIONS

Model:	94F 4-Leg Multipurpose Chair	94FC 4-Leg Multipurpose Chair With Casters
<b>Dimensions</b>		
Overall Width Armless	21.125"	21.125"
Overall Width With Arms	25.75"	25.75"
Overall Depth	22"	22"
Overall Height	33.5"	33.5"
Seat Width	18.25"	18.25"
Seat Depth	17"	17"
Seat Height	18" (Plastic) 19" (US/UP)	18" (Plastic) 19" (US/UP)
Back Width	19.125"	19.125"
Back Height	17"	17"
<b>Materials</b>		
COM	0.75 yd (US) 1 yd (UP)	0.75 yd (US) 1 yd (UP)
<b>Stacking</b>		
Max Cart Stacking	5	N/A
Max Floor Stacking	5	N/A
<b>Weight and Capacity</b>		
Weight Armless	13.5 lb	14 lb
Weight With Arms	14.5 lb	15 lb
Weight Capacity Warranty	250 lb	250 lb

*Upholstered seat only (US). Upholstered seat and back (UP).*

# Relay

## NESTER CHAIR

### *Durable and adaptable to the finish.*

Great to look at, Relay provides lasting comfort in a stylish design that makes an appealing multipurpose seating option for meeting, training, conference and break rooms. The seat and back are molded from high-impact thermoplastic for lasting durability and comfort. Add the optional upholstered seat and back for a more sophisticated, inviting look and added comfort.

Relay nesting chairs are available in black or silver frame and come with casters standard.



**EFFECTIVE DECEMBER 1, 2021**

### Featured Models

**GOOD :: \$375**

All plastic, armless, casters

**BETTER :: \$433**

Plastic back, upholstered seat, armless, casters, grade 1 textile



**BEST :: \$549**

Upholstered seat and back, fixed cantilever arm, casters, grade 1 textile

## Features

- Structurally reinforced and durable back
- High-impact polypropylene
- Fully upholstered, upholstered seat or plastic
- Nine plastic colors
- Armless or with fixed cantilever arms
- Black or silver frame
- 17 chairs in 10 feet of space
- Wall-saver frame design
- 250 lb weight capacity
- Complements Relay light task chair and stool; see page 139

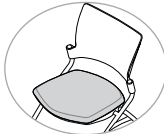
### 1. Back

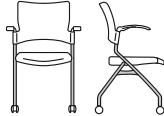

Back and Seat Style	Code	Price	
Plastic	No Code	\$375	
Upholstered Seat Only	US	\$433	
Upholstered Seat and Back	UP	\$491	

### 2. Frame

Frame Finish	Code	Price	
Black With Black Carpet Casters	94XB	+\$0	
Silver With Black Carpet Casters	94XS	+\$0	

## NESTER CHAIR

### 3. Arms

Arm Style	Code	Price	
Armless	A0	+\$0	
Fixed Cantilever	A60	+\$58	

### 4. Base

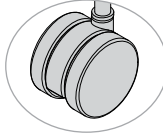
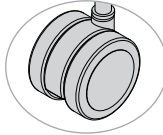
Casters	Code	Price	
Black Carpet Casters	C13	+\$0	
Hard Floor and Carpet Casters	C12	+\$40	

### 5. Miscellaneous

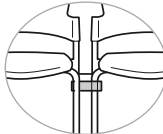
Accessories	Code	Price	
Ganging Bracket for Nester Models	GA10	+\$28	

## 6. Material

Protection	Code	Price	
<b>Fire Retardancy</b>			
CAL 133, Fabric, Quantities 1-49	133F	+ \$99	
CAL 133, Fabric, Quantities 50+	133F5	+ \$55	
CAL 133, Plastic, Any Quantity	133P	+ \$45	
Shell Color	Code	Price	
Arctic	SC21	+ \$0	
Black	SC1	+ \$0	
Chocolate	SC4	+ \$0	
Lagoon	SC15	+ \$0	
Latte	SC20	+ \$0	
Navy	SC5	+ \$0	
Red	SC19	+ \$0	
Slate	SC8	+ \$0	
Sterling	SC18	+ \$0	
Textile	Code	Price	
<b>Seat Only (US)</b>			
Fabric/Vinyl Grade 1	FG1/VG1	+ \$0	
COM	COM	+ \$22	
Fabric/Vinyl Grade 2	FG2/VG2	+ \$22	
Fabric/Vinyl Grade 3	FG3/VG3	+ \$45	
Fabric/Vinyl Grade 4	FG4/VG4	+ \$77	
Fabric/Vinyl Grade 5	FG5/VG5	+ \$116	
Fabric/Vinyl Grade 6	FG6/VG6	+ \$159	
Fabric/Vinyl Grade 7	FG7/VG7	+ \$200	
<b>Seat and Back (UP)</b>			
Fabric/Vinyl Grade 1	FG1/VG1	+ \$0	
COM	COM	+ \$34	
Fabric/Vinyl Grade 2	FG2/VG2	+ \$34	
Fabric/Vinyl Grade 3	FG3/VG3	+ \$74	
Fabric/Vinyl Grade 4	FG4/VG4	+ \$121	
Fabric/Vinyl Grade 5	FG5/VG5	+ \$174	
Fabric/Vinyl Grade 6	FG6/VG6	+ \$235	
Fabric/Vinyl Grade 7	FG7/VG7	+ \$296	

Please reference the Textile Reference Guide for pricing on fabric over grade 7.

## 7. Packaging

Packaging	Code	Price
Fully Assembled in Carton	AC4	+ \$0
Fully Assembled in Carton, Individually Packaged	AC1	+ \$20

## NESTER CHAIR

### SPECIFICATIONS

	94X Nester Chair
<b>Dimensions</b>	
Overall Width Armless	24"
Overall Width With Arms	25.75"
Overall Depth	25.25"
Overall Height	33.5"
Seat Width	18.25"
Seat Depth	17.25"
Seat Height	18.5" (Plastic) 19.5" (US/UP)
Back Width	19.125"
Back Height	17"
Weight Armless	21.5 lb
Weight With Arms	22.5 lb
<b>Materials</b>	
COM	0.75 yd (US) 1 yd (UP)
<b>Weight and Capacity</b>	
Weight Armless	21.5 lb
Weight With Arms	22.5 lb
Weight Capacity Warranty	250 lb

*Upholstered seat only (US). Upholstered seat and back (UP).*





# Rio

## MULTIPURPOSE CHAIR, COUNTER AND BAR STOOL

### *Design that responds to you.*

What goes into the award-winning line of Rio® plastic chairs? Patented flexing technology, for one. Our complete family of Rio models feature our patented Active Rebound Control (ARC) Technology®—a performance-minded flexor insert that supports a wide range of motion (20 full degrees to be exact) and responds precisely to the amount of weight pressed against it.

Add a fresh, modern color palette and you've got a seating solution that allows for more movement, day-long comfort and flexibility than any other chair in its class.

The Rio is an easy choice for multi-use spaces that require quick setups and breakdowns. Discover a collection of stackable chairs engineered to allow for better movement, applications across more environments and a longer product life.



**EFFECTIVE DECEMBER 1, 2021**

### Featured Models

#### **GOOD :: \$249**

4-leg chair, plastic seat and back, armless, standard multi-surface glides

#### **BETTER :: \$307**

4-leg chair, plastic back, upholstered seat, armless, standard multi-surface glides, grade 1 textile

#### **BEST :: \$423**



4-leg chair, upholstered seat and back, fixed arms, standard multi-surface glides, grade 1 textile

**MULTIPURPOSE CHAIR,  
COUNTER AND BAR STOOL**

**Features**

- 4-leg, wire rod, 24" counter or 30" bar stool
- Exceptional support and comfort
- Fully upholstered, upholstered seat or plastic
- ARC Technology® for weight-assisted flex
- 14 plastic shell colors
- All models offer two frame finishes with matching arm pads
- Left or right folding tablet arm that match the frame finish.
- Easy-grip edge that acts as pull handle
- Clean-out space
- 4-Leg plastic model stacks four on the floor; eight on the optional cart
- Plastic wire rod model stacks six on the floor; 15 on the optional cart
- 300 lb weight capacity warranty
- Complements Rio light task chair and stool; see page 143

**1. Frame**

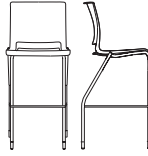

Frame Type	Code	Price	
Wire Rod Chair	1051 FT2	\$239	
4-Leg Chair	1051 FT1	\$249	
24" Counter Stool	1051 FT1 S9	\$399	
30" Bar Stool	1051 FT1 S2	\$399	

**1. Frame (Cont.)**

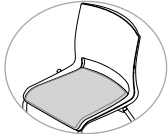

Frame Finish	Code	Price	
Black	FC1	+ \$0	
Silver (4-Leg Frame Only FT1)	FC2	+ \$0	
Chrome (Wire Rod Frame Only FT2)	FC15	+ \$0	

*Arms and glides, if selected, are black for black frames and fog for silver or chrome frames.*

**2. Back**

Back and Seat Style	Code	Price	
Plastic Seat	PS	+ \$0	
Upholstered Seat Only	US	+ \$58	
Upholstered Seat and Back	UP	+ \$116	

**3. Arms**

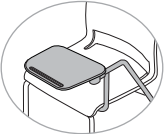
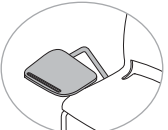
Arm Style	Code	Price	
Armless	A0	+ \$0	
Fixed Arms (4-Leg Frame Only FT1)	A91	+ \$58	
Fixed Arms (Wire Rod Frame Only FT2)	A131	+ \$58	
<b>Tablet Arm</b>			
Folding Tablet Arm, Left	RMTL	+ \$156	
Folding Tablet Arm, Right	RMTR	+ \$156	

*Not available with wire rod (FT1) frames or stools (S9/S2). Not stackable. Tablet arm will be black for black (FC1) frame or fog for silver (FC2) frame.*

**4. Base**

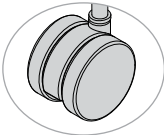
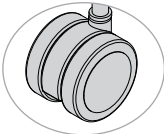
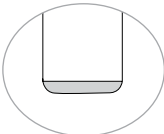
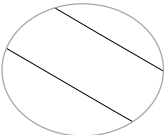
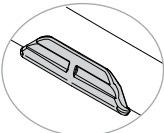
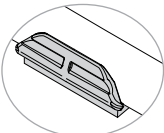
Casters or Glides	Code	Price	
<b>Casters</b>			
Carpet Casters	C13	+ \$40	
Hard Floor and Carpet Casters	C12	+ \$80	
<b>Glides for 4-Leg Chair and Stool Only</b>			
Standard Multi-Surface Glides	GL1	+ \$0	
Floor Saver Glides	GL3	+ \$17	
Steel Glides (Carpet Only)	GL4	+ \$17	
Performance Multi-Surface Glides	GL2	+ \$17	
<b>Glides for Wire Rod Frame Only</b>			
No Glides	G0	+ \$0	
Clear Glides	CGR	+ \$9	
Clear Glides With Felt	CGRF	+ \$22	

Please use caution when stacking models with casters to prevent frame damage. SitOnIt Seating does not warrant scratched frames.

**MULTIPURPOSE CHAIR, COUNTER AND BAR STOOL**

**5. Miscellaneous**

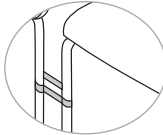
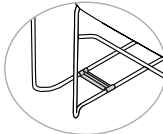
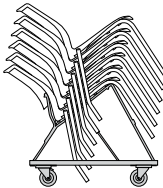
Accessories	Code	Price	
Ganging Bracket (For 4-Leg Chair FT1)	GG12	+ \$30	
Ganging Bracket (For Wire Rod Armless Models)	GG3	+ \$30	
Ganging Bracket (For Wire Rod Models With Arms)	GA4	+ \$30	
Stacking Cart	Cart	+ \$399	

Ganging brackets and stacking carts are not intended for use with caster models and are compatible with glides only. Accessories are not available for stools (S2/S9).

Due to the nature of upholstery, stacking may cause impressions on the seat. SitOnIt Seating does not warrant the effects of stacking on upholstery.

See page 538 for additional stacking requirements.

**6. Material**

Protection	Code	Price	
<b>Fire Retardancy</b>			
CAL 133, Fabric, Quantities 1-49	133F	+ \$64	
CAL 133, Fabric, Quantities 50+	133F5	+ \$20	
CAL 133, Plastic, Any Quantity	133P	+ \$10	
Shell Color	Code	Price	
Apple	SC24	+ \$0	
Arctic	SC21	+ \$0	
Bisque	SC7	+ \$0	
Black	SC1	+ \$0	
Chocolate	SC4	+ \$0	
Lagoon	SC15	+ \$0	
Latte	SC20	+ \$0	
Lemon	SC25	+ \$0	
Navy	SC5	+ \$0	
Pacific	SC22	+ \$0	
Red	SC19	+ \$0	
Slate	SC8	+ \$0	
Sterling	SC18	+ \$0	
Tangerine	SC23	+ \$0	

**6. Material (Cont.)**

Textile	Code	Price
<b>Seat Only (US)</b>		
Fabric/Vinyl Grade 1	FG1/VG1	+ \$0
COM	COM	+ \$22
Fabric/Vinyl Grade 2	FG2/VG2	+ \$22
Fabric/Vinyl Grade 3	FG3/VG3	+ \$45
Fabric/Vinyl Grade 4	FG4/VG4	+ \$77
Fabric/Vinyl Grade 5	FG5/VG5	+ \$116
Fabric/Vinyl Grade 6	FG6/VG6	+ \$159
Fabric/Vinyl Grade 7	FG7/VG7	+ \$200
<b>Seat and Back (UP)</b>		
Fabric/Vinyl Grade 1	FG1/VG1	+ \$0
COM	COM	+ \$34
Fabric/Vinyl Grade 2	FG2/VG2	+ \$34
Fabric/Vinyl Grade 3	FG3/VG3	+ \$74
Fabric/Vinyl Grade 4	FG4/VG4	+ \$121
Fabric/Vinyl Grade 5	FG5/VG5	+ \$174
Fabric/Vinyl Grade 6	FG6/VG6	+ \$235
Fabric/Vinyl Grade 7	FG7/VG7	+ \$296

Please reference the Textile Reference Guide for pricing on fabric over grade 7. Additional CAL 133 information can be found on page 10.

**7. Packaging**

Packaging	Code	Price
Fully Assembled in Carton	AC	+ \$0
Fully Assembled in Carton, Individually Packaged	AC1	+ \$20

**MULTIPURPOSE CHAIR, COUNTER AND BAR STOOL**

**CHAIR SPECIFICATIONS**

Model:	1051 FT1 4-Leg Multipurpose Chair	1051 FT2 Wire Rod Multipurpose Chair
<b>Dimensions</b>		
Overall Width Armless	21.2"	21.2"
Overall Width With Arms	22.2"	22.2"
Overall Depth	21.6"	23.2"
Overall Height	33.4"	33.4"
Seat Width	18.5"	18.5"
Seat Depth	18.2"	18.2"
Seat Height	17.9"	17.9"
Back Width	18.2"	18.2"
Back Height	17.5"	17.5"
<b>Materials</b>		
COM	0.85 yd (US) 1 yd (UP)	0.85 yd (US) 1 yd (UP)
<b>Weight and Capacity</b>		
Weight Armless	12.3 lb	15 lb
Weight With Arms	13.8 lb	18 lb
Weight Capacity Warranty	300 lb	300 lb

Upholstered seat only (US). Upholstered seat and back (UP).

**STOOL SPECIFICATIONS**

Model:	1051 FT1 S9 24" 4-Leg Counter Stool	1051 FT1 S2 30" 4-Leg Bar Stool
<b>Dimensions</b>		
Overall Width Armless	21.2"	21.2"
Overall Width With Arms	22.2"	22.2"
Overall Depth	22.2"	22.2"
Overall Height	40.35"	45.6"
Seat Width	18.5"	18.5"
Seat Depth	18.2"	18.2"
Seat Height	24.85"	30.1"
Back Width	18.2"	18.2"
Back Height	17.5"	17.5"
<b>Materials</b>		
COM	0.85 yd (US) 1 (UP)	0.85 yd (US) 1 (UP)
<b>Weight and Capacity</b>		
Weight Armless	17 lb	20.3 lb
Weight With Arms	18.7 lb	21.9 lb
Weight Capacity Warranty	300 lb	300 lb

Upholstered seat only (US). Upholstered seat and back (UP).

# Rowdy

MULTIPURPOSE CHAIR

## *Value to shout about.*

Rowdy is a one-piece multipurpose chair that will fit any space and any budget. Put Rowdy anywhere from meeting, training and conference rooms to auditorium and theater settings. The built-in hand-hold in the back allows easy repositioning. Stack Rowdy up to 40 high on its optional stacking cart and whisk them away for easy storage when space is at a premium.



*Good*

**EFFECTIVE DECEMBER 1, 2021**

## Featured Models

**GOOD :: \$178**

All-plastic seat and back, armless

**BETTER :: \$236**

Upholstered seat, plastic back, armless



**BEST :: \$294**

Upholstered seat, plastic back, fixed cantilever arms

## Features



- 14 plastic colors
- Built-in pull handle
- Wire-frame construction
- Black or chrome frame
- All plastic armless model stack 15 on the floor; 40 on the optional cart
- All plastic arm model stack 10 on the floor; 25 on the optional cart
- 250 lb weight capacity warranty

### 1. Seat

Seat Style	Code	Price	
Plastic	No Code	\$178	
Upholstered Seat	US	\$236	

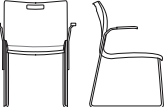

Do not stack upholstered seats.

### 2. Frame

Frame Finish	Code	Price	
Black Wire Rod Base	92 SB	+ \$0	
Chrome Wire Rod Base	92 SC	+ \$0	

## MULTIPURPOSE CHAIR

### 3. Arms

Arm Style	Code	Price	
Armless	A0	+ \$0	
Fixed Cantilever Arms	A47	+ \$58	

### 4. Base

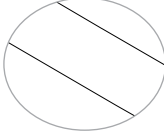
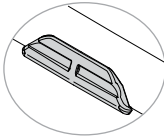
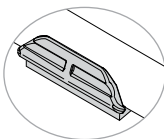
Glides	Code	Price	
No Glides	N	+ \$0	
Clear Glides	CGR	+ \$9	
Clear Glides With Felt	CGRF	+ \$22	

### 5. Miscellaneous

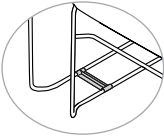
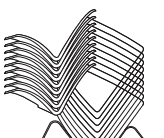
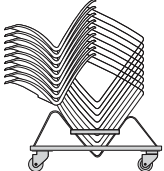
Accessories	Code	Price	
Ganging Bracket for Armless Models	GG5	+ \$12	
Ganging Bracket for Models With Arms	GA5	+ \$12	
Stacking Cart	CART	+ \$399	

Due to the nature of upholstery, stacking may cause impressions on the seat. SitOnIt Seating does not warrant the effects of stacking on upholstery.

See page 538 for additional stacking requirements.

## MULTIPURPOSE CHAIR

### 6. Material

Protection	Code	Price	
<b>Fire Retardancy</b>			
CAL 133 Fabric, Quantities 1-49	133F	+ \$99	
CAL 133 Fabric, Quantities 50+	133F5	+ \$55	
CAL 133 Plastic, Any Quantity	133P	+ \$45	
Shell Color	Code	Price	
Apple	SC24	+ \$0	
Arctic	SC21	+ \$0	
Bisque	SC7	+ \$0	
Black	SC1	+ \$0	
Chocolate	SC4	+ \$0	
Lagoon	SC15	+ \$0	
Latte	SC20	+ \$0	
Lemon	SC25	+ \$0	
Navy	SC5	+ \$0	
Pacific	SC22	+ \$0	
Red	SC19	+ \$0	
Slate	SC8	+ \$0	
Sterling	SC18	+ \$0	
Tangerine	SC23	+ \$0	
Seat Textile (For US)	Code	Price	
Fabric/Vinyl Grade 1	FG1/VG1	+ \$0	
COM	COM	+ \$22	
Fabric/Vinyl Grade 2	FG2/VG2	+ \$22	
Fabric/Vinyl Grade 3	FG3/VG3	+ \$45	
Fabric/Vinyl Grade 4	FG4/VG4	+ \$77	
Fabric/Vinyl Grade 5	FG5/VG5	+ \$116	
Fabric/Vinyl Grade 6	FG6/VG6	+ \$159	
Fabric/Vinyl Grade 7	FG7/VG7	+ \$200	

Please reference the Textile Reference Guide for pricing on fabric over grade 7.  
Stacking vinyl upholstered seat is not covered by warranty.

### 7. Packaging

Packaging	Code	Price	
Fully Assembled in Carton	AC4	+ \$0	
Fully Assembled in Carton, Individually Packaged	AC1	+ \$20	

### SPECIFICATIONS

<b>Model:</b>	92 Wire Rod Multipurpose Chair
<b>Dimensions</b>	
Overall Width Armless	19.5"
Overall Width With Arms	24.5"
Overall Depth	22"
Overall Height	33"
Seat Width	17"
Seat Depth	17"
Seat Height	17.5"
Back Width	19"
Back Height	16"
<b>Materials</b>	
COM	0.75 yd (US)
<b>Weight and Capacity</b>	
Weight Armless	13 lb
Weight With Arms	15 lb
Weight Capacity Warranty	250 lb



# Sprout

MULTIPURPOSE CHAIR

*It's friendly—  
ergo and eco.*

The supportive, flexing back on Sprout™ provides extra ergonomics while the simple shell + frame construction makes it 100% recyclable (and super easy to maintain). It pairs a refined silhouette with rugged durability and stacks higher than any other chair we have. Whether spread out, stacked up or stored away, Sprout is always ready to thrive.



Better

EFFECTIVE DECEMBER 1, 2021

## Featured Models

**GOOD :: \$197**

Plastic seat and back, armless, wire rod base, no glides

**BETTER :: \$206**

Plastic seat and back, armless, wire rod base, clear glides



### Features

- Space-saving design features high-density stacking (up to 40 on a cart and 10 on the floor)
- Ergonomic contouring with 10-degree flexing back provides superior comfort
- Durable and simple shell + frame construction means it's easy to maintain—and is 100% recyclable when it's time to replace
- Slim lines and silhouette complement an array of environments
- Large clean-out makes clean-up quick
- Ganging option locks chairs together effortlessly, creating well-ordered rows for seating
- Nine shell colors and two frame colors
- 300 lb weight capacity warranty

#### 1. Frame

Frame Type	Code	Price	
Wire Rod Chair	1181 FT2	\$197	

Frame Finish	Code	Price	
Black	FC1	+\$0	
Chrome	FC15	+\$0	

#### 2. Seat and Back

Seat	Code	Price	
Plastic	PS	+\$0	

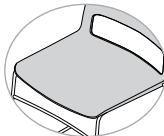
Back	Code	Price	
Plastic	PB	+\$0	

#### 3. Arms

Arm Style	Code	Price	
Armless	AR0	+\$0	

#### 4. Base

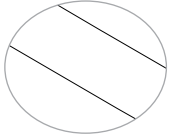
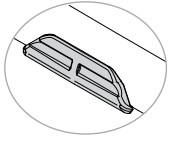
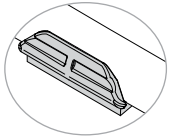
Glides	Code	Price	
No Glides	G0	+\$0	
Clear Glides	CGR	+\$9	
Clear Glides With Felt	CGRF	+\$22	

#### 5. Miscellaneous

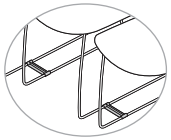
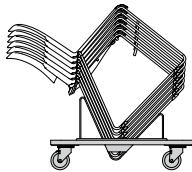
Accessories	Code	Price	
Ganging Bracket	GG	+\$12	
Stacking Cart	CART	+\$399	

See page 538 for additional stacking requirements.

### 6. Material

Shell Color	Code	Price
Arctic	SC21	+\$0
Black	SC1	+\$0
Chocolate	SC4	+\$0
Lagoon	SC15	+\$0
Latte	SC20	+\$0
Navy	SC5	+\$0
Red	SC19	+\$0
Slate	SC8	+\$0
Sterling	SC18	+\$0

### 7. Packaging

Packaging	Code	Price
Fully Assembled in Carton	AC	+\$0
Fully Assembled in Carton, Individually Packaged	AC1	+\$20

### SPECIFICATIONS

	Wire Rod 1181 FT2
<b>Dimensions</b>	
Overall Width	21.25"
Overall Depth	22"
Overall Height	32"
Seat Width	18.75"
Seat Depth	16"
Seat Height	18.5"
Back Width	18.5"
Back Height	16"
<b>Stacking</b>	
Maximum Floor Stacking	10
Maximum Cart Stacking	40
<b>Dimensions</b>	
Weight	14.5 lb
Weight Capacity Warranty	300 lb



Stacking Cart

# Wit Side

## MESH BACK MULTIPURPOSE CHAIR

### *Work smarter.*

A slimmer, stationary version of the task chair, our Wit Side is ideal for high-traffic settings like break rooms and cafeterias. Thanks to its ultra-lightweight frame and identical built-in pull handle, you can swing it around and rearrange spaces easily to accommodate the constant flow of crowded areas.



**EFFECTIVE DECEMBER 1, 2021**

### Featured Models

#### **GOOD :: \$304**

Mesh back, plastic seat, armless, standard multi-surface glides

#### **BETTER :: \$420**

Mesh back, upholstered seat, fixed arms, standard multi-surface glides, grade 1 textile

#### **BEST :: \$460**

Mesh back, upholstered seat, fixed arms, carpet casters, grade 1 textile

## Features

- Complements Wit task chair and Wit task stool
- Upholstered seat or plastic seat in three colors
- 12 mesh back colors
- Built-in pull handle
- Black or silver frame
- Wall-saver frame design
- Textured arm pads
- Stacks four on the floor, four on the optional cart
- Choose from two caster types and four glide options
- 300 lb weight capacity warranty
- Complements by Wit task chair and stool; see pages 175 and 171

### 1. Frame

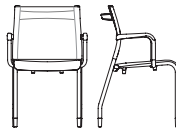
Frame Type	Code	Price	
4-Leg Side	2221 FT1 MB	\$420	
Frame Finish	Code	Price	
Black	FC1	+ \$0	
Silver	FC2	+ \$0	

### 2. Seat

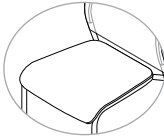
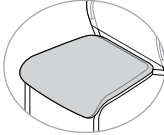
Seat Style	Code	Price	
Plastic Seat	PS	- \$58	
Upholstered Seat	US	+ \$0	

## MESH BACK MULTIPURPOSE CHAIR

### 3. Arms

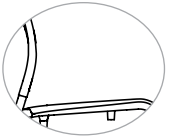
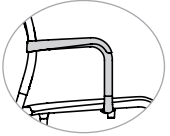
Arm Style	Code	Price	
Armless	AR0	- \$58	
Fixed Loop	AR1	+ \$0	

### 4. Base

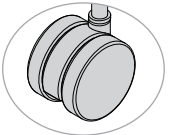
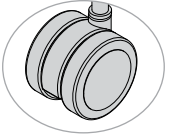
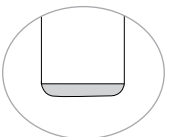
Casters or Glides	Code	Price	
<b>Casters</b>			
Black Carpet Casters	CS5	+ \$40	
Hard Floor and Carpet Casters	CS6	+ \$80	
<b>Glides</b>			
Standard Multi-Surface Glides	GL1	+ \$0	
Floor Saver Glides	GL3	+ \$17	
Steel Glides (Carpet Only)	GL4	+ \$17	
Performance Multi-Surface Glides	GL2	+ \$17	

Please use caution when stacking models with casters to prevent frame damage. SitOnIt Seating does not warrant scratched frames.

### 5. Miscellaneous

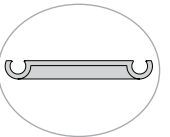
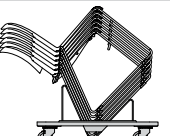
Accessories	Code	Price	
Ganging Brackets for Armless Models	GG	+ \$30	
Ganging Brackets for Models With Arms	GA	+ \$30	
Stacking Cart	CART	+ \$399	

Stacking cart (CART) is not compatible with caster models (CS5/CS6). See page 538 for additional stacking requirements.

Due to the nature of upholstery, stacking may cause impressions on the seat. SitOnIt Seating does not warrant the effects of stacking on upholstery.

## 6. Material

Protection	Code	Price	
<b>Fire Retardancy</b>			
CAL 133, Fabric, Quantities 1-49	133F	+ \$64	
CAL 133, Fabric, Quantities 50+	133F5	+ \$20	
CAL 133, Leather, Any Quantity	133L	+ \$119	
CAL 133, Plastic, Any Quantity	133P	+ \$10	
Mesh Color	Code	Price	
Apple	MC31	+ \$0	
Aqua	MC30	+ \$0	
Desert	MC22	+ \$0	
Electric Blue	MC24	+ \$0	
Fire	MC25	+ \$0	
Fog	MC23	+ \$0	
Grape	MC26	+ \$0	
Lemon	MC27	+ \$0	
Nickel	MC21	+ \$0	
Ocean	MC29	+ \$0	
Onyx	MC20	+ \$0	
Tangerine	MC28	+ \$0	
Shell Color (For PS)	Code	Price	
Black	SC1	+ \$0	
Navy	SC5	+ \$0	
Slate	SC8	+ \$0	
Seat Textile Only (For US)	Code	Price	
Fabric/Vinyl Grade 1	FG1/VG1	+ \$0	
COM	COM	+ \$22	
Fabric/Vinyl Grade 2	FG2/VG2	+ \$22	
Fabric/Vinyl Grade 3	FG3/VG3	+ \$45	
Fabric/Vinyl Grade 4	FG4/VG4	+ \$77	
Fabric/Vinyl Grade 5	FG5/VG5	+ \$116	
Fabric/Vinyl Grade 6	FG6/VG6	+ \$159	
Fabric/Vinyl Grade 7	FG7/VG7	+ \$200	
Leather Grade 1	LG1	+ \$140	
COL	COL	+ \$200	
Leather Grade 2	LG2	+ \$200	
Leather Grade 3	LG3	+ \$280	

Please reference the Textile Reference Guide for pricing on fabric over grade 7 or leather over grade 3.

## MESH BACK MULTIPURPOSE CHAIR

## 7. Packaging

Packaging	Code	Price	
Fully Assembled in Carton	AC3	+ \$0	
Individually Packaged	AC1	+ \$20	

## SPECIFICATIONS

Model:	2221 FT1 MB Mesh Side Chair	2221 FT1 MB Mesh Side Chair With Casters
<b>Dimensions</b>		
Overall Width Armless	19.25"	21.75"
Overall Width With Arms	22.5"	22.5"
Overall Depth	23"	24.5"
Overall Height	33.75"	33.75"
Seat Width	18.5"	18.5"
Seat Depth	16.25"	16.25"
Seat Height	18.07" (PS) 18.53" (US)	18.07" (PS) 18.53" (US)
Back Width	19.25"	19.25"
Back Height	17"	17"
<b>Materials</b>		
COM	0.75 yd	0.75 yd
COL	10 sq ft	10 sq ft
<b>Stacking</b>		
Max Cart Stacking	4	Not Recommended
Max Floor Stacking	4	4
<b>Weight and Capacity</b>		
Cart Stacking Weight Armless	112 lb	Not Recommended
Cart Stacking Weight With Arms	128 lb	Not Recommended
Floor Stacking Weight Armless	62 lb	62 lb
Floor Stacking Weight With Arms	78 lb	78 lb
Weight Armless	14 lb (PS) 15.5 lb (US)	14 lb (PS) 15.5 lb (US)
Weight With Arms	18 lb (PS) 19.5 lb (US)	18 lb (PS) 19.5 lb (US)
Weight Capacity Warranty	300 lb	300 lb

Plastic seat (PS). Upholstered seat (US).

# Wit Side

## THINTEX BACK MULTIPURPOSE CHAIR

### *Work smarter.*

A slimmer, stationary version of the task chair, our Wit Side is ideal for high-traffic settings like break rooms and cafeterias. Thanks to its ultra-lightweight frame and identical built-in pull handle, you can swing it around and rearrange spaces easily to accommodate the constant flow of crowded areas.



Better

**EFFECTIVE DECEMBER 1, 2021**

### Featured Models

**GOOD :: \$345**

Thintex back, plastic seat, armless, standard multi-surface glides

**BETTER :: \$461**

Thintex back, upholstered seat, fixed arms, standard multi-surface glides, grade 1 textile

**BEST :: \$501**

Thintex back, upholstered seat, fixed arms, carpet casters, grade 1 textile

### Features

- Complements Wit task chair and Wit task stool
- Upholstered seat or plastic seat in three colors
- 12 Thintex back colors
- Built-in pull handle
- Black or silver frame
- Wall-saver frame design
- Textured arm pads
- Stacks four on the floor, four on the optional cart
- Choose from two caster types and four glide options
- 300 lb weight capacity warranty
- Complements by Wit task chair and stool; see pages 175 and 179

#### 1. Frame

Frame Type	Code	Price	
4-Leg Side	2221 FT1 TXB	\$461	

Frame Finish	Code	Price	
Black	FC1	+ \$0	
Silver	FC2	+ \$0	

#### 2. Back

Back Material	Code	Price	
Fabric	TX1	+ \$0	
Vinyl	TX2	+ \$0	

#### 3. Seat

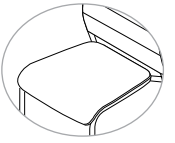
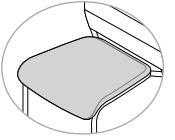
Seat Style	Code	Price	
Plastic Seat	PS	- \$58	
Upholstered Seat	US	+ \$0	

#### 4. Arms

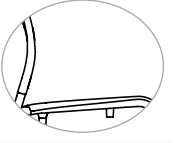
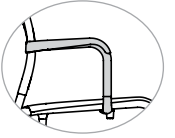
Arm Style	Code	Price	
Armless	AR0	- \$58	
Fixed Loop	AR1	+ \$0	

#### 5. Base

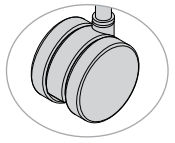
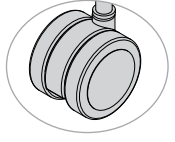
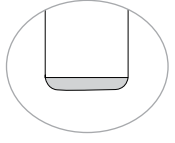
Casters or Glides	Code	Price	
<b>Casters</b>			
Black Carpet Casters	CS5	+ \$40	
Hard Floor and Carpet Casters	CS6	+ \$80	
<b>Glides</b>			
Standard Multi-Surface Glides	GL1	+ \$0	
Floor Saver Glides	GL3	+ \$17	
Steel Glides (Carpet Only)	GL4	+ \$17	
Performance Multi-Surface Glides	GL2	+ \$17	

Please use caution when stacking models with casters to prevent frame damage. SitOnIt Seating does not warrant scratched frames.

## 6. Miscellaneous

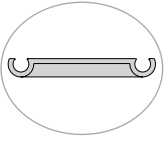
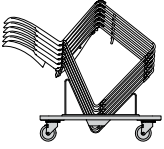
Accessories	Code	Price	
Ganging Brackets for Armless Models	GG	+ \$30	
Ganging Brackets for Models With Arms	GA	+ \$30	
Stacking Cart	CART	+ \$399	

Stacking cart (CART) is not compatible with caster models (CS5/CS6). See page 538 for additional stacking requirements.

Due to the nature of upholstery, stacking may cause impressions on the seat. SitOnIt Seating does not warrant the effects of stacking on upholstery.

## 7. Material

Protection	Code	Price	
<b>Fire Retardancy</b>			
CAL 133, Fabric, Quantities 1-49	133F	+ \$64	
CAL 133, Fabric, Quantities 50+	133F5	+ \$20	
CAL 133, Leather, Any Quantity	133L	+ \$119	
CAL 133, Plastic, Any Quantity	133P	+ \$10	
Thintex Color	Code	Price	
Apple	MC31	+ \$0	
Aqua	MC30	+ \$0	
Desert	MC22	+ \$0	
Electric Blue	MC24	+ \$0	
Fire	MC25	+ \$0	
Fog	MC23	+ \$0	
Grape	MC26	+ \$0	
Lemon	MC27	+ \$0	
Nickel	MC21	+ \$0	
Ocean	MC29	+ \$0	
Onyx	MC20	+ \$0	
Tangerine	MC28	+ \$0	
Shell Color (For PS)	Code	Price	
Black	SC1	+ \$0	
Navy	SC5	+ \$0	
Slate	SC8	+ \$0	

## THINTEX BACK MULTIPURPOSE CHAIR

### 7. Material (Cont.)

Seat Textile (For US)	Code	Price	
Fabric/Vinyl Grade 1	FG1/VG1	+ \$0	
COM	COM	+ \$22	
Fabric/Vinyl Grade 2	FG2/VG2	+ \$22	
Fabric/Vinyl Grade 3	FG3/VG3	+ \$45	
Fabric/Vinyl Grade 4	FG4/VG4	+ \$77	
Fabric/Vinyl Grade 5	FG5/VG5	+ \$116	
Fabric/Vinyl Grade 6	FG6/VG6	+ \$159	
Fabric/Vinyl Grade 7	FG7/VG7	+ \$200	
Leather Grade 1	LG1	+ \$140	
COL	COL	+ \$200	
Leather Grade 2	LG2	+ \$200	
Leather Grade 3	LG3	+ \$280	

Please reference the Textile Reference Guide for pricing on fabric over grade 7 or leather over grade 3.





### 8. Packaging

Packaging	Code	Price
Fully Assembled in Carton	AC3	+ \$0
Fully Assembled in Carton, Individually Packaged	AC1	+ \$20

### SPECIFICATIONS

Model:	2221 FT1 TXB Thintex Side Chair	2221 FT1 TXB Thintex Side Chair With Casters
<b>Dimensions</b>		
Overall Width Armless	19.25"	21.75"
Overall Width With Arms	22.5"	22.5"
Overall Depth	23"	24.5"
Overall Height	33.75"	33.75"
Seat Width	18.5"	18.5"
Seat Depth	16.25"	16.25"
Seat Height	18.07" (PS) 18.53" (US)	18.07" (PS) 18.53" (US)
Back Width	19.25"	19.25"
Back Height	17"	17"
<b>Materials</b>		
COM	0.75 yd	0.75 yd
COL	10 sq ft	10 sq ft
<b>Stacking</b>		
Maximum Cart Stacking	4	Not Recommended
Maximum Floor Stacking	4	4
<b>Weight and Capacity</b>		
Cart Stacking Weight Armless	112 lb	Not Recommended
Cart Stacking Weight With Arms	128 lb	Not Recommended
Floor Stacking Weight Armless	62 lb	62 lb
Floor Stacking Weight With Arms	78 lb	78 lb
Weight Armless	14 lb (PS) 15.5 lb (US)	14 lb (PS) 15.5 lb (US)
Weight With Arms	18 lb (PS) 19.5 lb (US)	18 lb (PS) 19.5 lb (US)
Weight Capacity Warranty	300 lb	300 lb

Plastic seat (PS). Upholstered seat (US).



# Lounge

CLUB CHAIR | SETTEE | SOFA  
MODULAR LOUNGE  
TANDEM SEATING | MULTISEATING  
LINKING TABLES | COFFEE TABLES

# Statement of Line

CLUB CHAIR | SETTEE | SOFA | MODULAR LOUNGE | MULTISEATING  
TANDEM SEATING | BARIATRIC | LINKING TABLE | COFFEE TABLE

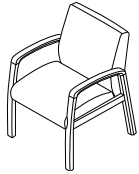

**Aviera**  
Guest and Bariatric Seating  
VRG ..... 291

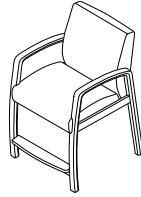

**Aviera**  
Hip Chair  
VRG FS3 ..... 296



**Aviera**  
Patient Seating  
VRP ..... 300

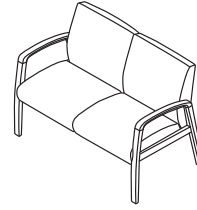

**Aviera**  
Freespan 2-Seat  
VRF SN2 ..... 305

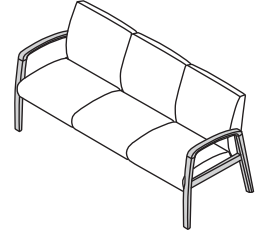

**Aviera**  
Freespan 3-Seat  
VRF SN3 ..... 305

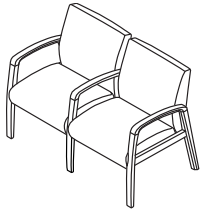

**Aviera**  
Pre-Configured 2-Seat  
VRC SN2 ..... 310

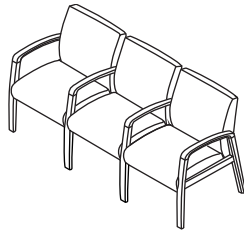

**Aviera**  
Pre-Configured 3-Seat  
VRC SN3 ..... 310

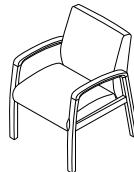

**Aviera**  
Start Tandem Seating  
VRM FS4 ..... 315

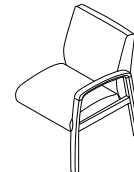

**Aviera**  
Center/End Tandem Seating  
VRM FS5/FS6 ..... 315

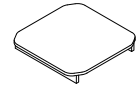

**Aviera**  
Center Linking Table  
VRL TTL1 ..... 320



**Aviera**  
End Linking Table  
VRL TTL3 ..... 320



**Aviera**  
Round Corner Linking Table  
VRL TTL4 ..... 320

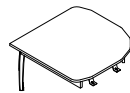

**Aviera**  
Square Corner Linking Table  
VRL TTL4 ..... 320

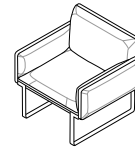

**Cameo**  
Single Seat With Dual Arms  
CAM SN1 FS8 ..... 324

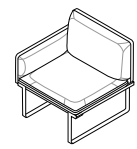

**Cameo**  
Single Seat With Right Arm  
CAM SN1 FS10 ..... 324

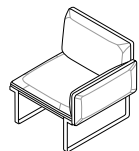

**Cameo**  
Single Seat With Left Arm  
CAM SN1 FS12 ..... 324

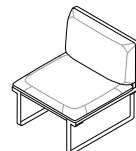

**Cameo**  
Single Seat Armless  
CAM SN1 FS17 ..... 324

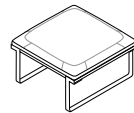

**Cameo**  
Single Seat Bench  
CAM SN1 FS2 ..... 324

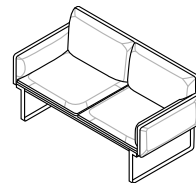

**Cameo**  
2-Seater With Dual Arms  
CAM SN2 FS8 ..... 324

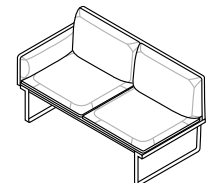

**Cameo**  
2-Seater With Right Arm  
CAM SN2 FS10 ..... 324

# Statement of Line

CLUB CHAIR | SETTEE | SOFA | MODULAR LOUNGE  
TANDEM SEATING | MULTISEATING | LINKING TABLE | COFFEE TABLE

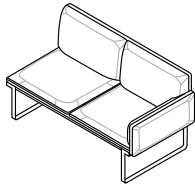

**Cameo**  
2-Seater With Left Arm  
CAM SN2 FS12..... 324

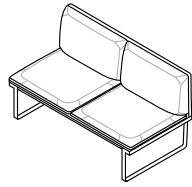

**Cameo**  
2-Seater Armless  
CAM SN2 FS17..... 324

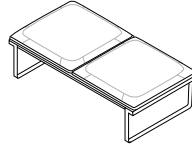

**Cameo**  
2-Seater Bench  
CAM SN2 FS2..... 324

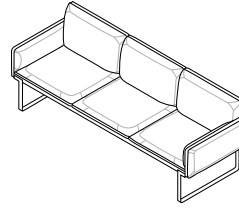

**Cameo**  
3-Seater With Dual Arms  
CAM SN3 FS8..... 324

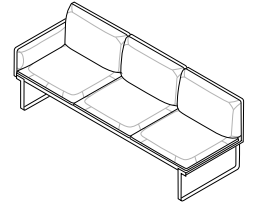

**Cameo**  
3-Seater With Right Arm  
CAM SN3 FS10..... 324

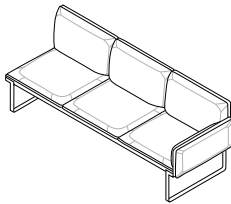

**Cameo**  
3-Seater With Left Arm  
CAM SN3 FS12..... 324

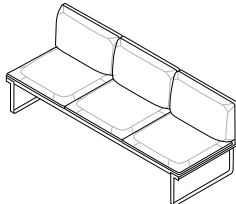

**Cameo**  
3-Seater Armless  
CAM SN3 FS17..... 324

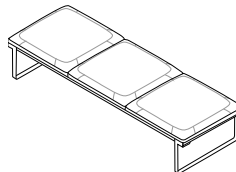

**Cameo**  
3-Seater Bench  
CAM SN3 FS2..... 324

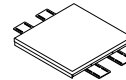

**Cameo**  
Inline Table  
CAMT TTL1..... 329

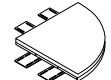

**Cameo**  
Corner Table  
CAMT TTL4..... 329

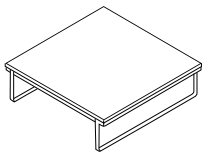

**Cameo**  
Square Coffee Table  
CAMT TT8..... 329

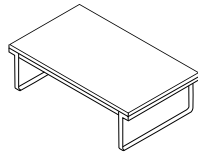

**Cameo**  
Rectangular Coffee Table  
CAMT TT9..... 329

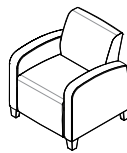

**Composium**  
Curve Club Chair  
CP AS3 SN1..... 331

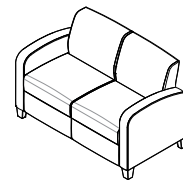

**Composium**  
Curve Settee  
CP AS3 SN2..... 331

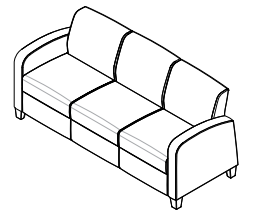

**Composium**  
Curve Sofa  
CP AS3 SN3..... 331

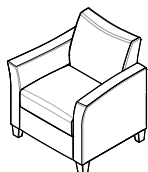

**Composium**  
Flair Club Chair  
CP AS2 SN1..... 336

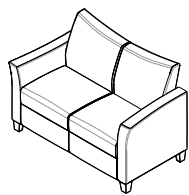

**Composium**  
Flair Settee  
CP AS2 SN2..... 336

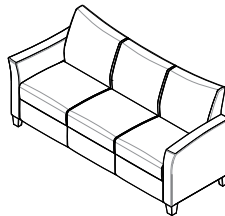

**Composium**  
Flair Sofa  
CP AS2 SN3..... 336

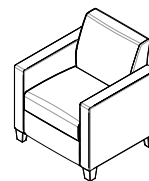

**Composium**  
Sharp Club Chair  
CP AS1 SN1..... 341

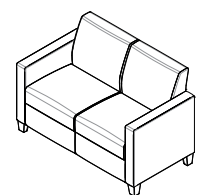

**Composium**  
Sharp Settee  
CP AS1 SN2..... 341

# Statement of Line

CLUB CHAIR | SETTEE | SOFA | MODULAR LOUNGE | MULTISEATING  
TANDEM SEATING | BARIATRIC | LINKING TABLE | COFFEE TABLE

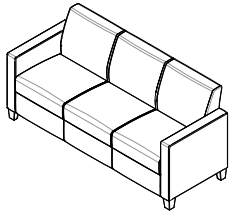

## Composium

Sharp Sofa  
CP AS1 SN3 ..... 341

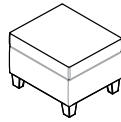

## Composium

Ottoman  
CP FS1 ..... 346

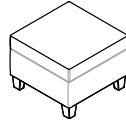

## Composium

Single-Seat Bench  
CP FS2 SN1 ..... 346

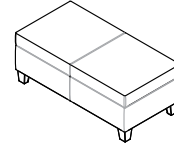

## Composium

Double-Seat Bench  
CP FS2 SN2 ..... 346

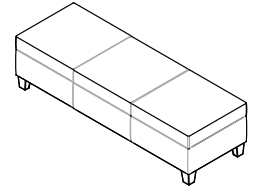

## Composium

Three-Seat Bench  
CP FS2 SN3 ..... 346



## Envoi

Midback Lounge Chair  
ENV BH4 ..... 351



## Envoi

Highback Lounge Chair  
ENV BH5 ..... 351



## Gobi

Midback Lounge Chair  
GBI BH4 ..... 355



## Nano

Triangle  
NNO FS13 ..... 365



## Nano

Triangle Table  
NNO FS13 TM3/TM4 ..... 365



## Nano

Diamond  
NNO FS14 ..... 365



## Nano Table

Diamond  
NNO FS14 TM3/TM4 ..... 365

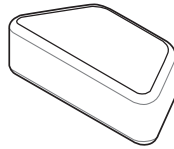

## Nano

Trapezoid  
NNO FS15 ..... 365

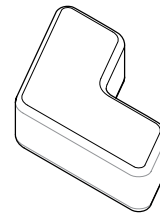

## Nano

Trapezoid  
NNO FS15 ..... 365

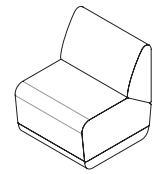

## Paséa

Single Seat  
PAS FS17 SS1 ..... 363

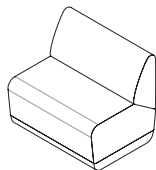

## Paséa

1.5 Seat  
PAS FS17 SS2 ..... 374

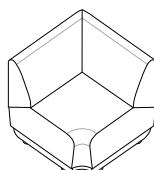

## Paséa

90-Degree Corner Seat  
PAS FS17 SS5 ..... 374

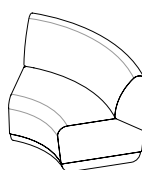

## Paséa

90-Degree Corner Seat  
PAS FS17 SS5 ..... 374

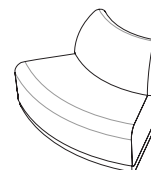

## Paséa

90-Degree Corner Seat  
PAS FS17 SS5 ..... 374

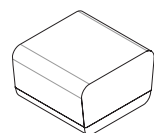

## Paséa

90-Degree Corner Seat  
PAS FS2 BNS1 ..... 374

# Statement of Line

CLUB CHAIR | SETTEE | SOFA | MODULAR LOUNGE | MULTISEATING  
TANDEM SEATING | BARIATRIC | LINKING TABLE | COFFEE TABLE

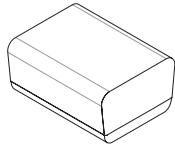

**Paséa**  
90-Degree Corner Seat  
PAS FS2 BNS2.....374

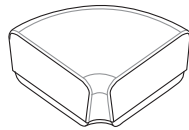

**Paséa**  
90-Degree Corner Seat  
PAS FS2 BNS6.....374

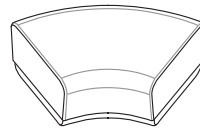

**Paséa**  
120-Degree Bench  
PAS FS17 SS5 .....374

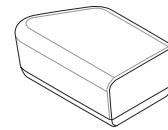

**Paséa**  
Right-Angled End Bench  
PAS FS2 BNS3.....374

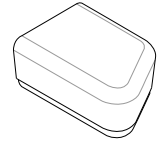

**Paséa**  
Left-Angled End Bench  
PAS FS2 BNS4.....374



**Paséa**  
Mini Round Ottoman  
PAS FS1 OS1 .....382



**Paséa**  
Mini Square Ottoman  
PAS FS1 OS3.....382

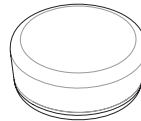

**Paséa**  
Large Round Ottoman  
PAS FS1 OS2.....382



**Paséa**  
Large Square Ottoman  
PAS FS1 OS4 .....382

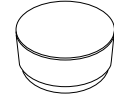

**Paséa**  
Mini Round Table  
PAS FS1 OS1 TM3 .....382



**Paséa**  
Mini Square Table  
PAS FS1 OS3 TM3 .....382

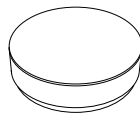

**Paséa**  
Large Round Table  
PAS FS1 OS2 TM3 .....382

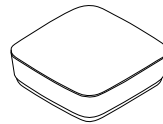

**Paséa**  
Large Square Table  
PAS FS1 OS4 TM3 .....382

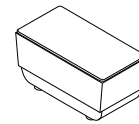

**Paséa**  
13" x 27" Table  
FS18 BNS7 .....386

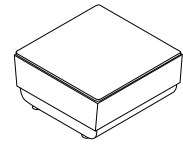

**Paséa**  
27" x 27" Table  
FS18 BNS1 .....386

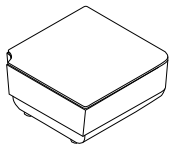

**Paséa**  
90-Degree Corner Table  
FS18 BNS5 .....386

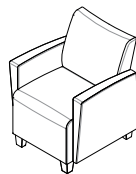

**Visit Modular**  
Club Chair With Two  
Upholstered Arms  
VS FS8.....389

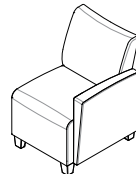

**Visit Modular**  
Club Chair With  
Upholstered Left Arm  
VS FS12 .....389

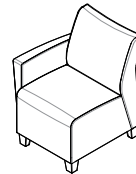

**Visit Modular**  
Club Chair With  
Upholstered Right Arm  
VS FS10 .....389

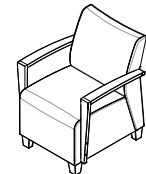

**Visit Modular**  
Club Chair With  
Two Wood Arms  
VS FS7 .....389

# Statement of Line

CLUB CHAIR | SETTEE | SOFA | MODULAR LOUNGE | MULTISEATING  
TANDEM SEATING | BARIATRIC | LINKING TABLE | COFFEE TABLE

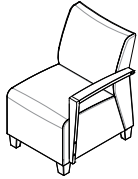

---

## Visit Modular

Club Chair With Wood Left  
Arm | VS FS11 ..... 389

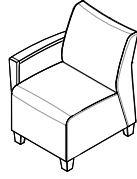

---

## Visit Modular

Club Chair With Wood Right  
Arm | VS FS9 ..... 389

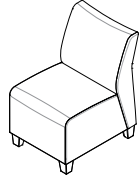

---

## Visit Modular

Armless Club Chair  
VS ..... 389

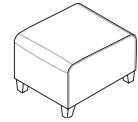

---

## Visit Modular

Ottoman  
VS FS1 ..... 389

# Aviera

## GUEST AND BARIATRIC SEATING

### *Comfort that lasts.*

Whether lobby, lounge, welcoming or waiting, you can rest easy with supremely comfortable do-it-all seating for your public spaces. Aviera makes it easy to configure endlessly and effortlessly—across an entire collection—with worry-free design and lasting durability, including metal or wood frames that feature an integrated steel structure. Discover an industry-leading seating solution and get peace of mind for any project.



*Metal*

**EFFECTIVE DECEMBER 1, 2021**

### Featured Models

#### **METAL :: \$1,338**

Metal frame, 21" seat, open arms, polyurethane arm caps, multi-upholstery, grade 2 vinyl seat, grade 5 vinyl back

#### **WOOD :: \$1,682**

Maple frame, 21" seat, open arms, no arm caps, multi-upholstery, grade 4 vinyl seat, grade 7 vinyl back

#### **BARIATRIC :: \$2,014**

Metal frame, 30" seat, open arms, polyurethane arm caps, multi-upholstery, grade 4 vinyl seat, grade 7 fabric back



### Features

- Easy ingress and egress with 18.5" seat height and waterfall seat design
- Clean-out space
- Steel-frame construction with metal-to-metal connections
- Beveled, wall-saving frame design
- Two frame materials: Durable aluminum frame or wood frame with silver ion anti-microbial finish
- Three metal frame finishes or four wood frame finishes
- Polyurethane, wood or solid surface arm caps
- Replaceable parts including seat, back, arms, arm caps and arm insets
- 21"/24" seats: 500 lb weight capacity warranty  
30"/44" bariatric seats: 750 lb weight capacity warranty



Wood

### 1. Product

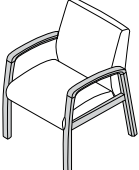

Model	Code	Price	
Guest	VRG	\$958	

### 2. Frame

Frame Material	Code	Price	
Metal	FM3	+ \$0	
<b>Wood</b>			
Beech	FM2	+ \$10	
Maple	FM1	+ \$68	
Frame Finish	Code	Price	
<b>For Metal Frame</b>			
Silver Metallic	FCM1	+ \$0	
Graphite	FCM2	+ \$0	
Taupe	FCM3	+ \$0	
<b>For Wood Frame</b>			
Clear Maple	FCW1	+ \$0	
Medium Cherry	FCW2	+ \$0	
Amber Mahogany	FCW3	+ \$0	
Espresso	FCW4	+ \$0	
Stain-to-Match	STM	+ \$70	
New Custom Stain	STL	+ \$275	
Frame Options	Code	Price	
Protective Guard Clear Tape	FX1	+ \$84	

*New Custom Stain (STL): If stain is not in our library, add this one-time \$275 net fee in addition to the \$70 stain-to-match (STM) cost.*

### 3. Seat

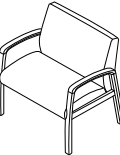
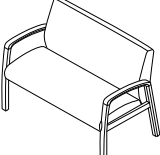
Seat Width	Code	Price	
21"	SW21	+ \$0	
24"	SW24	+ \$55	
<b>Bariatric</b>			
30"	SW30	+ \$275	
44"	SW44	+ \$500	

### 4. Arms

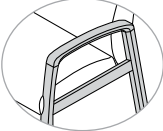
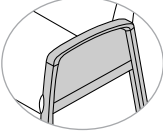
Arm Type	Code	Price	
Open Arm	AT1	+ \$0	
Upholstered Arm	AT2	+ \$86	

### GUEST AND BARIATRIC SEATING

### 4. Arms (Cont.)

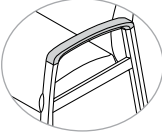
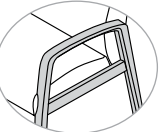
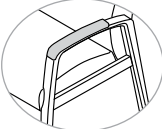
Arm Cap Material	Code	Price	
<b>For Metal Frame</b>			
Polyurethane	ACP4	+ \$0	
Wood	ACP3	+ \$80	
Solid Surface	ACP5	+ \$450	
<b>For Wood Frame</b>			
No Arm Caps	ACP0	+ \$0	
Polyurethane	ACP2	+ \$120	

Arm Cap Finish	Code	Price	
<b>For Polyurethane Arm Caps</b>			
Black	RMC3	+ \$0	
Fog	RMC4	+ \$0	
Dark Grey	RMC5	+ \$0	
<b>For Wood Arm Caps</b>			
Clear Maple	FCW1	+ \$0	
Medium Cherry	FCW2	+ \$0	
Amber Mahogany	FCW3	+ \$0	
Espresso	FCW4	+ \$0	
Stain-to-Match	STM	+ \$70	
New Custom Stain	STL	+ \$275	
<b>For Solid Surface Arm Caps</b>			
Designer White	TSS2	+ \$0	

*New Custom Stain (STL): If stain is not in our library, add this one-time \$275 net fee in addition to the \$70 stain-to-match (STM) cost.*

*Upholstered arm textile will match seat textile.*

### 5. Material

Protection	Code	Price	
<b>Fire Retardancy</b>			
CAL 133	UCAL	+ \$100	
Cleaning	Code	Price	
<b>Moisture Barrier</b>			
Seat Only	UM2	+ \$65	
Back Only	UM1	+ \$65	
Seat and Back	UM3	+ \$130	
Fully Upholstered	Code	Price	
<b>Seat and Back Textile</b>		21"/24"	30"/44"
Fabric/Vinyl Grade 1	FG1/VG1	+ \$0	+ \$0
COM	COM	+ \$60	+ \$100
Fabric/Vinyl Grade 2	FG2/VG2	+ \$60	+ \$100
Fabric/Vinyl Grade 3	FG3/VG3	+ \$150	+ \$220
Fabric/Vinyl Grade 4	FG4/VG4	+ \$275	+ \$365
Fabric/Vinyl Grade 5	FG5/VG5	+ \$415	+ \$525
Fabric/Vinyl Grade 6	FG6/VG6	+ \$575	+ \$705
Fabric/Vinyl Grade 7	FG7/VG7	+ \$735	+ \$885
Leather Grade 1	LG1	+ \$600	+ \$685
COL	COL	+ \$700	+ \$805
Leather Grade 2	LG2	+ \$700	+ \$805
Leather Grade 3	LG3	+ \$800	+ \$1,005
Multi-Upholstery	Code	Price	
<b>Multi-Upholstery Upcharge</b>		21"/24"	30"/44"
Multi-Upholstery Upcharge	UMU	+ \$113	+ \$113
<b>Seat Textile Only</b>		21"/24"	30"/44"
Fabric/Vinyl Grade 1	FG1/VG1	+ \$0	+ \$0
COM	COM	+ \$26	+ \$42
Fabric/Vinyl Grade 2	FG2/VG2	+ \$26	+ \$42
Fabric/Vinyl Grade 3	FG3/VG3	+ \$63	+ \$93
Fabric/Vinyl Grade 4	FG4/VG4	+ \$116	+ \$154
Fabric/Vinyl Grade 5	FG5/VG5	+ \$175	+ \$221
Fabric/Vinyl Grade 6	FG6/VG6	+ \$242	+ \$297
Fabric/Vinyl Grade 7	FG7/VG7	+ \$309	+ \$372
Leather Grade 1	LG1	+ \$252	+ \$288
COL	COL	+ \$294	+ \$339
Leather Grade 2	LG2	+ \$294	+ \$339

### 5. Material (Cont.)

Leather Grade 3	LG3	+ \$336	+ \$423
Multi-Upholstery	Code	Price	
<b>Back Textile Only</b>		21"/24"	30"/44"
Fabric/Vinyl Grade 1	FG1/VG1	+ \$0	+ \$0
COM	COM	+ \$35	+ \$58
Fabric/Vinyl Grade 2	FG2/VG2	+ \$35	+ \$58
Fabric/Vinyl Grade 3	FG3/VG3	+ \$87	+ \$128
Fabric/Vinyl Grade 4	FG4/VG4	+ \$160	+ \$212
Fabric/Vinyl Grade 5	FG5/VG5	+ \$241	+ \$305
Fabric/Vinyl Grade 6	FG6/VG6	+ \$334	+ \$409
Fabric/Vinyl Grade 7	FG7/VG7	+ \$427	+ \$514
Leather Grade 1	LG1	+ \$348	+ \$398
COL	COL	+ \$406	+ \$467
Leather Grade 2	LG2	+ \$406	+ \$467
Leather Grade 3	LG3	+ \$464	+ \$583

If different fabrics are selected for the seat and back, add the multi-upholstery upcharge as well, even if the fabrics are the same grade.

Please reference the Textile Reference Guide for pricing on fabric over grade 7 and leather over grade 3. Additional CAL 133 information can be found on page 10.

### 6. Options

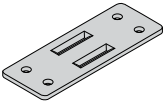
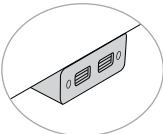
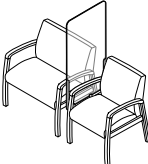
Ganging Brackets	Code	Price	
Ganging Brackets	XGV	+ \$103	
Power Options	Code	Price	
Power, Left	PFL	+ \$250	
Power, Right	PFR	+ \$250	
Screen	Code	Price	
Sector Seating Screen	3097 XRX	+ \$460	
Packaging	Code	Price	
Fully Assembled in a Carton	P1	+ \$0	

### SPECIFICATIONS

Model:	21"	24"
<b>Dimensions</b>		
Height	34.5"	34.5"
Width	24.5"	27.5"
Depth	26.5"	26.5"
Arm Height (Height of Arms From Floor)	25.75"	25.75"
Arm Height (From Seat to Top of Arm)	7.25"	7.25"
Width Between Arms	20.75"	23.75"
Seat Width	21.75"	24.75"
Seat Depth	19"	19"
Seat Height	18.5"	18.5"
Back Height	18.5"	18.5"
<b>Materials</b>		
COM (Fully Upholstered)	1.9 yd	1.9 yd
COM (Multi-Upholstery)		
Seat Only	1.2 yd	1.2 yd
Back Only	1.1 yd	1.6 yd
COL (Fully Upholstered)	29.4 sq ft	43.4 sq ft
<b>Weight and Capacity</b>		
Weight	38 lb (FM3) 33 lb (FM1/FM2)	40 lb (FM3) 35 lb (FM1/FM2)
Weight Capacity Warranty	500 lb	500 lb

*Metal frame (FM3), Beech wood frame (FM2), Maple wood frame (FM1).*

*Yardage requirements for COM and COL are for solid and non-directional fabrics. Additional material may be required for larger repeating patterns.*

### SPECIFICATIONS: BARIATRIC SIZES

Model:	30"	44"
<b>Dimensions</b>		
Height	34.5"	34.5"
Width	33.5"	47.5"
Depth	26.5"	26.5"
Arm Height (Height of Arms From Floor)	25.75"	25.75"
Arm Height (From Seat to Top of Arm)	7.25"	7.25"
Width Between Arms	29.75"	43.75"
Seat Width	30.75"	44.75"
Seat Depth	19"	19"
Seat Height	18.5"	18.5"
Back Height	18.5"	18.5"
<b>Materials</b>		
COM (Fully Upholstered)	3.1 yd	3.4 yd
COM (Multi-Upholstery)		
Seat Only	1.2 yd	1.6 yd
Back Only	1.9 yd	1.9 yd
COL (Fully Upholstered)	47.6 sq ft	50.4 sq ft
<b>Weight and Capacity</b>		
Weight	50 lb (FM3) 45 lb (FM1/FM2)	77 lb (FM3) 72 lb (FM1/FM2)
Weight Capacity Warranty	750 lb	750 lb

*Metal frame (FM3), Beech wood frame (FM2), Maple wood frame (FM1).*

*Yardage requirements for COM and COL are for solid and non-directional fabrics. Additional material may be required for larger repeating patterns.*



*Bariatric*

# Aviera

## HIP CHAIR

### *Comfort that lasts.*

Whether lobby, lounge, welcoming or waiting, you can rest easy with supremely comfortable do-it-all seating for your public spaces. Aviera makes it easy to configure endlessly and effortlessly—across an entire collection—with worry-free design and lasting durability, including metal or wood frames that feature an integrated steel structure. Discover an industry-leading seating solution and get peace of mind for any project.



*Metal*

**EFFECTIVE DECEMBER 1, 2021**

### Featured Models

#### **METAL :: \$2,132**

Metal frame, 21" seat, open arms, polyurethane arm caps, fully upholstered, grade 7 vinyl seat and back

#### **WOOD :: \$2,047**

Maple frame, 21" seat, open arms, no arm caps, multi-upholstery, grade 4 vinyl seat, grade 5 vinyl back

## HIP CHAIR

### Features

- Easy ingress and egress with waterfall seat design
- Clean-out space
- Steel-frame construction with metal-to-metal connections
- Beveled, wall-saving frame design
- Elevated footrest with a non-slip textured surface
- Two frame materials: Durable aluminum frame or wood frame with silver ion anti-microbial finish
- Three metal frame finishes or four wood frame finishes
- Polyurethane, wood or solid surface arm caps
- Replaceable parts including seat, back, arms, arm caps and arm insets
- 500 lb weight capacity warranty



Wood

### 1. Product

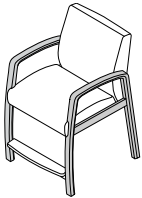
Model	Code	Price	
Hip Chair	VRG FS3	\$1,397	

### 2. Frame

Frame Material	Code	Price	
Metal	FM3	+ \$0	
<b>Wood</b>			
Beech	FM2	+ \$93	
Maple	FM1	+ \$180	
Frame Finish	Code	Price	
<b>For Metal Frame</b>			
Silver Metallic	FCM1	+ \$0	
Graphite	FCM2	+ \$0	
Taupe	FCM3	+ \$0	
<b>For Wood Frame</b>			
Clear Maple	FCW1	+ \$0	
Medium Cherry	FCW2	+ \$0	
Amber Mahogany	FCW3	+ \$0	
Espresso	FCW4	+ \$0	
Stain-to-Match	STM	+ \$70	
New Custom Stain	STL	+ \$275	
Frame Options	Code	Price	
Protective Guard Clear Tape	FX1	+ \$84	

*New Custom Stain (STL): If stain is not in our library, add this one-time \$275 net fee in addition to the \$70 stain-to-match (STM) cost.*

### 3. Arms

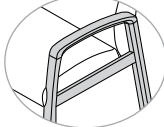
Arm Type	Code	Price	
Open Arm	AT1	+\$0	

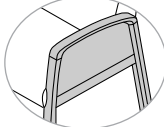
Upholstered Arm	AT2	+\$86	
-----------------	-----	-------	---

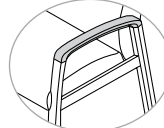
Arm Cap Material	Code	Price	
<b>For Metal Frame</b>			
Polyurethane	ACP4	+\$0	
Wood	ACP3	+\$80	
Solid Surface	ACP5	+\$450	

<b>For Wood Frame</b>			
No Arm Cap	ACP0	+\$0	

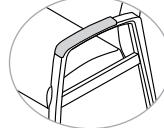
Polyurethane	ACP2	+\$120	
--------------	------	--------	---

Arm Cap Finish	Code	Price	
<b>For Polyurethane Arm Caps</b>			
Black	RMC3	+\$0	
Fog	RMC4	+\$0	
Dark Grey	RMC5	+\$0	
<b>For Wood Arm Caps</b>			
Clear Maple	FCW1	+\$0	
Medium Cherry	FCW2	+\$0	
Amber Mahogany	FCW3	+\$0	
Espresso	FCW4	+\$0	
Stain-to-Match	STM	+\$70	
New Custom Stain	STL	+\$275	
<b>For Solid Surface Arm Caps</b>			
Designer White	TSS2	+\$0	

*New Custom Stain (STL): If stain is not in our library, add this one-time \$275 net fee in addition to the \$70 stain-to-match (STM) cost.*

*Upholstered arm textile will match seat textile.*

### HIP CHAIR

### 4. Material

Protection	Code	Price
<b>Fire Retardancy</b>		
CAL 133	UCAL	+\$100
<b>Cleaning</b>		
<b>Moisture Barrier</b>		
Seat Only	UM2	+\$65
Back Only	UM1	+\$65
Seat and Back	UM3	+\$130
<b>Fully Upholstered</b>		
Fabric/Vinyl Grade 1	FG1/VG1	+\$0
COM	COM	+\$60
Fabric/Vinyl Grade 2	FG2/VG2	+\$60
Fabric/Vinyl Grade 3	FG3/VG3	+\$150
Fabric/Vinyl Grade 4	FG4/VG4	+\$275
Fabric/Vinyl Grade 5	FG5/VG5	+\$415
Fabric/Vinyl Grade 6	FG6/VG6	+\$575
Fabric/Vinyl Grade 7	FG7/VG7	+\$735
Leather Grade 1	LG1	+\$600
COL	COL	+\$700
Leather Grade 2	LG2	+\$700
Leather Grade 3	LG3	+\$800
<b>Multi-Upholstery</b>		
Multi-Upholstery Upcharge	UMU	+\$113
<b>Seat Textile Only</b>		
Fabric/Vinyl Grade 1	FG1/VG1	+\$0
COM	COM	+\$26
Fabric/Vinyl Grade 2	FG2/VG2	+\$26
Fabric/Vinyl Grade 3	FG3/VG3	+\$63
Fabric/Vinyl Grade 4	FG4/VG4	+\$116
Fabric/Vinyl Grade 5	FG5/VG5	+\$175
Fabric/Vinyl Grade 6	FG6/VG6	+\$242
Fabric/Vinyl Grade 7	FG7/VG7	+\$309
Leather Grade 1	LG1	+\$252
COL	COL	+\$294
Leather Grade 2	LG2	+\$294
Leather Grade 3	LG3	+\$336

## 4. Material (Cont.)

Multi-Upholstery	Code	Price
<b>Back Textile Only</b>		
Fabric/Vinyl Grade 1	FG1/VG1	+ \$0
COM	COM	+ \$35
Fabric/Vinyl Grade 2	FG2/VG2	+ \$35
Fabric/Vinyl Grade 3	FG3/VG3	+ \$87
Fabric/Vinyl Grade 4	FG4/VG4	+ \$160
Fabric/Vinyl Grade 5	FG5/VG5	+ \$241
Fabric/Vinyl Grade 6	FG6/VG6	+ \$334
Fabric/Vinyl Grade 7	FG7/VG7	+ \$427
Leather Grade 1	LG1	+ \$348
COL	COL	+ \$406
Leather Grade 2	LG2	+ \$406
Leather Grade 3	LG3	+ \$464

If different fabrics are selected for the seat and back, add the multi-upholstery upcharge as well, even if the fabrics are the same grade.

Please reference the *Textile Reference Guide* for pricing on fabric over grade 7 and leather over grade 3. Additional CAL 133 information can be found on page 10.

## 5. Packaging

Packaging	Code	Price
Fully Assembled in a Carton	P1	+ \$0

## HIP CHAIR

### SPECIFICATIONS

Model:	VRG FS3 21" Hip Chair
<b>Dimensions</b>	
Height	40.25"
Width	24.5"
Depth	28.25"
Arm Height (Height of Arms From Floor)	31.75"
Arm Height (From Seat to Top of Arm)	7.25"
Width Between Arms	20.75"
Seat Width	21.75"
Seat Depth	19"
Seat Height	24.5"
Back Height	18.5"
Footrest Height (From Floor)	7"
<b>Materials</b>	
COM (Fully Upholstered)	1.9 yd
COM (Multi-Upholstery)	
Seat Only	1.2 yd
Back Only	1.1 yd
COL (Fully Upholstered)	29.4 sq ft
<b>Weight and Capacity</b>	
Weight	38 lb (FM3) 33 lb (FM1/FM2)
Weight Capacity Warranty	500 lb

Metal frame (FM3), Beech wood frame (FM2), Maple wood frame (FM1).

Yardage requirements for COM and COL are for solid and non-directional fabrics. Additional material may be required for larger repeating patterns.



# Aviera

## PATIENT SEATING

### *Comfort that lasts.*

Whether lobby, lounge, welcoming or waiting, you can rest easy with supremely comfortable do-it-all seating for your public spaces. Aviera makes it easy to configure endlessly and effortlessly—across an entire collection—with worry-free design and lasting durability, including metal or wood frames that feature an integrated steel structure. Discover an industry-leading seating solution and get peace-of-mind for any project.



*Metal*

**EFFECTIVE DECEMBER 1, 2021**

### Featured Models

#### **METAL :: \$1,614**

Metal frame, 21" seat, open arms, polyurethane arm caps, multi-upholstery, grade 4 vinyl seat and grade 5 vinyl back

#### **WOOD :: \$1,868**

Maple frame, 21" seat, open arms, no arm caps, multi-upholstery, grade 4 vinyl seat and grade 7 vinyl back

#### **BARIATRIC :: \$2,088**

Metal frame, 30" seat, open arms, polyurethane arm caps, multi-upholstery, grade 2 vinyl seat and grade 7 fabric back

### Features

- Easy ingress and egress with waterfall seat design
- Clean-out space
- Steel-frame construction with metal-to-metal connections
- Beveled, wall-saving frame design
- Two frame materials: Durable aluminum frame or wood frame with silver ion anti-microbial finish
- Three metal frame finishes or four wood frame finishes
- Polyurethane, wood or solid surface arm caps
- Replaceable parts including seat, back, arms, arm caps and arm insets
- 21"/24" seat: 500 lb weight capacity warranty  
30" bariatric seat: 750 lb weight capacity warranty



### 1. Product



Model	Code	Price	
Aviera Patient	VRP	\$1,144	

### 2. Frame

Frame Material	Code	Price	
Metal	FM3	+ \$0	
<b>Wood</b>			
Beech	FM2	+ \$10	
Maple	FM1	+ \$68	
Frame Finish	Code	Price	
<b>For Metal Frame</b>			
Silver Metallic	FCM1	+ \$0	
Graphite	FCM2	+ \$0	
Taupe	FCM3	+ \$0	
<b>For Wood Frame</b>			
Clear Maple	FCW1	+ \$0	
Medium Cherry	FCW2	+ \$0	
Amber Mahogany	FCW3	+ \$0	
Espresso	FCW4	+ \$0	
Stain-to-Match	STM	+ \$70	
New Custom Stain	STL	+ \$275	
Frame Options	Code	Price	
Protective Guard Clear Tape	FX1	+ \$84	

*New Custom Stain (STL): If stain is not in our library, add this one-time \$275 net fee in addition to the \$70 stain-to-match (STM) cost.*

### 3. Seat

Seat Width	Code	Price	
21"	SW21	+ \$0	
24"	SW24	+ \$55	
<b>Bariatric</b>			
30"	SW30	+ \$275	

### 4. Arms

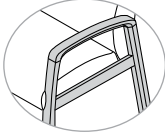
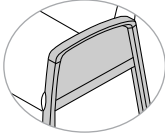
Arm Type	Code	Price	
Open Arm	AT1	+ \$0	
Upholstered Arm	AT2	+ \$86	

*Upholstered arm textile will match seat textile.*

## PATIENT SEATING

### 4. Arms (Cont.)

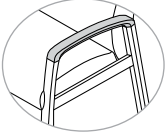
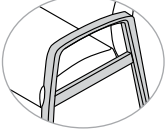
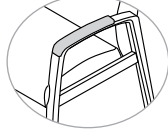
Arm Cap Material	Code	Price	
<b>For Metal Frame</b>			
Polyurethane	ACP4	+ \$0	
Wood	ACP3	+ \$80	
Solid Surface	ACP5	+ \$450	
<b>For Wood Frame</b>			
No Arm Cap	ACP0	+ \$0	
Polyurethane	ACP2	+ \$120	
<b>Arm Cap Finish</b>			
<b>For Polyurethane Arm Caps</b>			
Black	RMC3	+ \$0	
Fog	RMC4	+ \$0	
Dark Grey	RMC5	+ \$0	
<b>For Wood Arm Caps</b>			
Clear Maple	FCW1	+ \$0	
Medium Cherry	FCW2	+ \$0	
Amber Mahogany	FCW3	+ \$0	
Espresso	FCW4	+ \$0	
Stain-to-Match	STM	+ \$70	
New Custom Stain	STL	+ \$275	
<b>For Solid Surface Arm Caps</b>			
Designer White	TSS2	+ \$0	

*New Custom Stain (STL): If stain is not in our library, add this one-time \$275 net fee in addition to the \$70 stain-to-match (STM) cost.*

## 5. Material (Cont.)

Multi-Upholstery	Code	Price
------------------	------	-------

### 5. Material

Protection	Code	Price
------------	------	-------

#### Fire Retardancy

CAL 133	UCAL	+ \$100
---------	------	---------

Cleaning	Code	Price
----------	------	-------

#### Moisture Barrier

Seat Only	UM2	+ \$65
-----------	-----	--------

Back Only	UM1	+ \$65
-----------	-----	--------

Seat and Back	UM3	+ \$130
---------------	-----	---------

Fully Upholstered	Code	Price
-------------------	------	-------

Seat and Back Textile	21"/24"	30"
-----------------------	---------	-----

Fabric/Vinyl Grade 1	FG1/VG1	+ \$0	+ \$0
----------------------	---------	-------	-------

COM	COM	+ \$60	+ \$100
-----	-----	--------	---------

Fabric/Vinyl Grade 2	FG2/VG2	+ \$60	+ \$100
----------------------	---------	--------	---------

Fabric/Vinyl Grade 3	FG3/VG3	+ \$150	+ \$220
----------------------	---------	---------	---------

Fabric/Vinyl Grade 4	FG4/VG4	+ \$275	+ \$365
----------------------	---------	---------	---------

Fabric/Vinyl Grade 5	FG5/VG5	+ \$415	+ \$525
----------------------	---------	---------	---------

Fabric/Vinyl Grade 6	FG6/VG6	+ \$575	+ \$705
----------------------	---------	---------	---------

Fabric/Vinyl Grade 7	FG7/VG7	+ \$735	+ \$885
----------------------	---------	---------	---------

Leather Grade 1	LG1	+ \$600	+ \$685
-----------------	-----	---------	---------

COL	COL	+ \$700	+ \$805
-----	-----	---------	---------

Leather Grade 2	LG2	+ \$700	+ \$805
-----------------	-----	---------	---------

Leather Grade 3	LG3	+ \$800	+ \$1,005
-----------------	-----	---------	-----------

Multi-Upholstery	Code	Price
------------------	------	-------

	21"/24"	30"
--	---------	-----

Multi-Upholstery Upcharge	UMU	+ \$113	+ \$113
---------------------------	-----	---------	---------

Seat Textile Only	21"/24"	30"
-------------------	---------	-----

Fabric/Vinyl Grade 1	FG1/VG1	+ \$0	+ \$0
----------------------	---------	-------	-------

COM	COM	+ \$26	+ \$42
-----	-----	--------	--------

Fabric/Vinyl Grade 2	FG2/VG2	+ \$26	+ \$42
----------------------	---------	--------	--------

Fabric/Vinyl Grade 3	FG3/VG3	+ \$63	+ \$93
----------------------	---------	--------	--------

Fabric/Vinyl Grade 4	FG4/VG4	+ \$116	+ \$154
----------------------	---------	---------	---------

Fabric/Vinyl Grade 5	FG5/VG5	+ \$175	+ \$221
----------------------	---------	---------	---------

Fabric/Vinyl Grade 6	FG6/VG6	+ \$242	+ \$297
----------------------	---------	---------	---------

Fabric/Vinyl Grade 7	FG7/VG7	+ \$309	+ \$372
----------------------	---------	---------	---------

Leather Grade 1	LG1	+ \$252	+ \$288
-----------------	-----	---------	---------

COL	COL	+ \$294	+ \$339
-----	-----	---------	---------

Leather Grade 2	LG2	+ \$294	+ \$339
-----------------	-----	---------	---------

Leather Grade 3	LG3	+ \$336	+ \$423
-----------------	-----	---------	---------

## PATIENT SEATING

## 5. Material (Cont.)

Multi-Upholstery	Code	Price
------------------	------	-------

Back Textile Only	21"/24"	30"
-------------------	---------	-----

Fabric/Vinyl Grade 1	FG1/VG1	+ \$0	+ \$0
----------------------	---------	-------	-------

COM	COM	+ \$35	+ \$58
-----	-----	--------	--------

Fabric/Vinyl Grade 2	FG2/VG2	+ \$35	+ \$58
----------------------	---------	--------	--------

Fabric/Vinyl Grade 3	FG3/VG3	+ \$87	+ \$128
----------------------	---------	--------	---------

Fabric/Vinyl Grade 4	FG4/VG4	+ \$160	+ \$212
----------------------	---------	---------	---------

Fabric/Vinyl Grade 5	FG5/VG5	+ \$241	+ \$305
----------------------	---------	---------	---------

Fabric/Vinyl Grade 6	FG6/VG6	+ \$334	+ \$409
----------------------	---------	---------	---------

Fabric/Vinyl Grade 7	FG7/VG7	+ \$427	+ \$514
----------------------	---------	---------	---------

Leather Grade 1	LG1	+ \$348	+ \$398
-----------------	-----	---------	---------

COL	COL	+ \$406	+ \$467
-----	-----	---------	---------

Leather Grade 2	LG2	+ \$406	+ \$467
-----------------	-----	---------	---------

Leather Grade 3	LG3	+ \$464	+ \$583
-----------------	-----	---------	---------

If different fabrics are selected for the seat and back, add the multi-upholstery upcharge as well, even if the fabrics are the same grade.

Please reference the Textile Reference Guide for pricing on fabric over grade 7 and leather over grade 3. Additional CAL 133 information can be found on page 10.

## 6. Options

Ganging Brackets	Code	Price
------------------	------	-------

Ganging Brackets	XGV	+ \$103
------------------	-----	---------

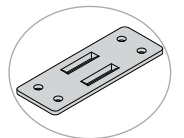

Power Options	Code	Price
---------------	------	-------

Power, Left	PFL	+ \$250
-------------	-----	---------

Power, Right	PFR	+ \$250
--------------	-----	---------

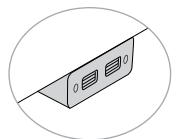

Screen	Code	Price
--------	------	-------

Sector Seating Screen	3097 XRX	+ \$460
-----------------------	----------	---------

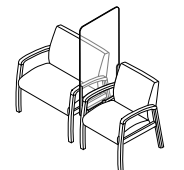

## 7. Packaging

Packaging	Code	Price
-----------	------	-------

Fully Assembled in a Carton	P1	+ \$0
-----------------------------	----	-------

EFFECTIVE DECEMBER 1, 2021 | GSA SIN #: 33721

### SPECIFICATIONS

Model:	VRP SW21 21" Seat	VRP SW24 24" Seat	VRP SW30 30" Seat
<b>Dimensions</b>			
Height	44"	44"	44"
Width	24.5"	27.5"	33.5"
Depth	26.5"	26.5"	26.5"
Arm Height (Height of Arms From Floor)	25.75"	25.75"	25.75"
Arm Height (From Seat to Top of Arm)	7.25"	7.25"	7.25"
Width Between Arms	20.75"	23.75"	29.75"
Seat Width	21.75"	24.75"	30.75"
Seat Depth	19"	19"	19"
Seat Height	18.5"	18.5"	18.5"
Back Height	28.5"	28.5"	28.5"
<b>Materials</b>			
COM (Fully Upholstered)	2.8 yd	2.8 yd	3.8 yd
COM (Multi-Upholstery)			
Seat Only	1.2 yd	1.2 yd	1.2 yd
Back Only	1.9 yd	2.2 yd	2.5 yd
COL (Fully Upholstered)	35 sq ft	43.4 sq ft	50 sq ft
<b>Weight and Capacity</b>			
Weight	42 lb (FM3) 37 lb (FM1/FM2)	44 lb (FM3) 39 lb (FM1/FM2)	57 lb (FM3) 52 lb (FM1/FM2)
Weight Capacity Warranty	500 lb	500 lb	750 lb

*Metal frame (FM3). Beech wood frame (FM2), Maple wood frame (FM1).*

*Yardage requirements for COM and COL are for solid and non-directional fabrics. Additional material may be required for larger repeating patterns.*



*Bariatric*

# Aviera

## FREESPAN MULTISEATING

### *Comfort that lasts.*

Whether lobby, lounge, welcoming or waiting, you can rest easy with supremely comfortable do-it-all seating for your public spaces. Aviera makes it easy to configure endlessly and effortlessly—across an entire collection—with worry-free design and lasting durability, including metal or wood frames that feature an integrated steel structure. Discover an industry-leading seating solution and get peace-of-mind for any project.



*Metal 2-Seat*

**EFFECTIVE DECEMBER 1, 2021**

### Featured Models

**METAL 2-SEAT :: \$2,385**

Metal frame, 21" seat, open arms, polyurethane arm caps, multi-upholstery, grade 3 vinyl seat and grade 5 vinyl back

**WOOD 2-SEAT :: \$2,749**

Maple frame, 21" seat, open arms, no arm caps, multi-upholstery, grade 2 vinyl seat and grade 7 fabric back

**METAL 3-SEAT :: \$3,664**

Metal frame, 24" seat, open arms, solid surface arm caps, multi-upholstery, grade 4 vinyl seat and grade 2 fabric back

### Features

- Easy ingress and egress with waterfall seat design
- Clean-out space
- Steel frame construction with metal-to-metal connections
- Beveled, wall-saving frame design
- Two frame materials: Durable aluminum frame or wood frame with silver ion anti-microbial finish
- Three metal frame finishes or four wood frame finishes
- Polyurethane, wood or solid surface arm caps
- Replaceable parts including seat, back, arms, arm caps and arm insets.
- 2-Seat: 525 lb weight capacity warranty  
3-Seat: 750 lb weight capacity warranty

### 1. Product

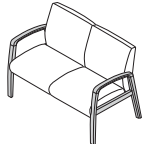
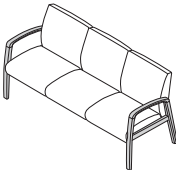
Model	Code	Price	
Aviera 2-Seat Freespan	VRF SN2	\$1,664	
Aviera 3-Seat Freespan	VRF SN3	\$2,484	

### 2. Frame

Frame Material	Code	Price	
Metal	FM3	+ \$0	
<b>Wood</b>			
Beech	FM2	+ \$10	
Maple	FM1	+ \$68	
Center Arm	Code	Price	
No Center Arm	AC0	+ \$0	

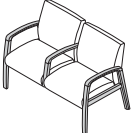
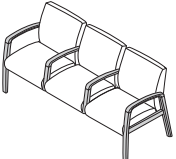
2-Seat With Center Arm	AC1	+ \$30	
3-Seat With Center Arm	AC1	+ \$60	

Frame Finish	Code	Price	
<b>For Metal Frame</b>			
Silver Metallic	FCM1	+ \$0	
Graphite	FCM2	+ \$0	
Taupe	FCM3	+ \$0	
<b>For Wood Frame</b>			
Clear Maple	FCW1	+ \$0	
Medium Cherry	FCW2	+ \$0	
Amber Mahogany	FCW3	+ \$0	
Espresso	FCW4	+ \$0	
Stain-to-Match	STM	+ \$70	
New Custom Stain	STL	+ \$275	

Frame Options	Code	Price	
Protective Guard Clear Tape	FX1	+ \$84	

*New Custom Stain (STL): If stain is not in our library, add this one-time \$275 net fee in addition to the \$70 stain-to-match (STM) cost.*

### 3. Seat

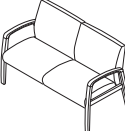
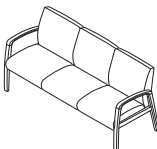
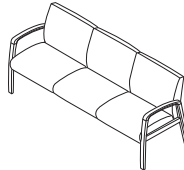
Seat Width	Code	Price	
21", 2-Seat	SW21	+ \$0	
24", 2-Seat	SW21	+ \$110	
21", 3-Seat	SW24	+ \$0	
24", 3-Seat	SW24	+ \$165	

### 4. Arms

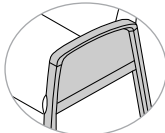
Arm Type	Code	Price	
Open Arm	AT0	+ \$0	
Upholstered Arm, 2-Seat No Center Arm	AT1	+ \$86	
Upholstered Arm, 2-Seat With Center Arm	AT1	+ \$129	
Upholstered Arm, 3-Seat No Center Arm	AT1	+ \$86	
Upholstered Arm, 3-Seat With Center Arm	AT1	+ \$172	

*Upholstered arm textile will match seat textile.*

### FREESPAN MULTISEATING

### 4. Arms (Cont.)

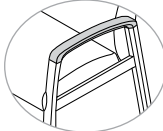
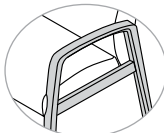
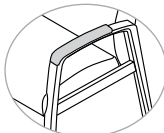
Arm Cap Material	Code	Price	
<b>For Metal Frame</b>			
Polyurethane	ACP4	+ \$0	
Wood, No Center Arm	ACP3	+ \$80	
Wood, 2-Seat With Center Arm	ACP3	+ \$120	
Wood, 3-Seat With Center Arm	ACP3	+ \$160	
Solid Surface No Center Arm	ACP5	+ \$450	
Solid Surface, 2-Seat With Center Arm	ACP5	+ \$675	
Solid Surface, 3-Seat With Center Arm	ACP5	+ \$900	
<b>For Wood Frame</b>			
No Arm Cap	ACP0	+ \$0	
Polyurethane, No Center Arm	ACP2	+ \$120	
Polyurethane, 2-Seat With Center Arm	ACP2	+ \$180	
Polyurethane, 3-Seat With Center Arm	ACP2	+ \$240	
Arm Cap Finish	Code	Price	
<b>For Polyurethane Arm Caps</b>			
Black	RMC3	+ \$0	
Fog	RMC4	+ \$0	
Dark Grey	RMC5	+ \$0	
<b>For Wood Arm Caps</b>			
Clear Maple	FCW1	+ \$0	
Medium Cherry	FCW2	+ \$0	
Amber Mahogany	FCW3	+ \$0	
Espresso	FCW4	+ \$0	
Stain-to-Match	STM	+ \$70	
New Custom Stain	STL	+ \$275	
<b>For Solid Surface Arm Caps</b>			
Designer White	TSS2	+ \$0	

*New Custom Stain (STL): If stain is not in our library, add this one-time \$275 net fee in addition to the \$70 stain-to-match (STM) cost.*



### 5. Material

Protection	Code	Price	
<b>Fire Retardancy</b>		2-Seat	3-Seat
CAL 133	UCAL	+ \$200	+ \$300
Cleaning	Code	Price	
<b>Moisture Barrier</b>		2-Seat	3-Seat
Seat Only	UM2	+ \$130	+ \$195
Back Only	UM1	+ \$130	+ \$195
Seat and Back	UM3	+ \$260	+ \$390
Fully Upholstered	Code	Price	
<b>Seat and Back Textile</b>		2-Seat	3-Seat
Fabric/Vinyl Grade 1	FG1/VG1	+ \$0	+ \$0
COM	COM	+ \$120	+ \$180
Fabric/Vinyl Grade 2	FG2/VG2	+ \$120	+ \$180
Fabric/Vinyl Grade 3	FG3/VG3	+ \$300	+ \$450
Fabric/Vinyl Grade 4	FG4/VG4	+ \$550	+ \$825
Fabric/Vinyl Grade 5	FG5/VG5	+ \$830	+ \$1,245
Fabric/Vinyl Grade 6	FG6/VG6	+ \$1,150	+ \$1,725
Fabric/Vinyl Grade 7	FG7/VG7	+ \$1,470	+ \$2,205
Leather Grade 1	LG1	+ \$1,200	+ \$1,800
COL	COL	+ \$1,400	+ \$2,100
Leather Grade 2	LG2	+ \$1,400	+ \$2,100
Leather Grade 3	LG3	+ \$1,600	+ \$2,400
Multi-Upholstery	Code	Price	
		2-Seat	3-Seat
Multi-Upholstery Upcharge	UMU	+ \$113	+ \$113
Seat Textile Only		2-Seat	3-Seat
Fabric/Vinyl Grade 1	FG1/VG1	+ \$0	+ \$0
COM	COM	+ \$51	+ \$76
Fabric/Vinyl Grade 2	FG2/VG2	+ \$51	+ \$76
Fabric/Vinyl Grade 3	FG3/VG3	+ \$126	+ \$189
Fabric/Vinyl Grade 4	FG4/VG4	+ \$231	+ \$347
Fabric/Vinyl Grade 5	FG5/VG5	+ \$349	+ \$523
Fabric/Vinyl Grade 6	FG6/VG6	+ \$483	+ \$725
Fabric/Vinyl Grade 7	FG7/VG7	+ \$618	+ \$927
Leather Grade 1	LG1	+ \$504	+ \$756
COL	COL	+ \$588	+ \$882
Leather Grade 2	LG2	+ \$588	+ \$882
Leather Grade 3	LG3	+ \$672	+ \$1,008

### 5. Material (Cont.)

Multi-Upholstery	Code	Price	
<b>Back Textile Only</b>		2-Seat	3-Seat
Fabric/Vinyl Grade 1	FG1/VG1	+ \$0	+ \$0
COM	COM	+ \$70	+ \$105
Fabric/Vinyl Grade 2	FG2/VG2	+ \$70	+ \$105
Fabric/Vinyl Grade 3	FG3/VG3	+ \$174	+ \$261
Fabric/Vinyl Grade 4	FG4/VG4	+ \$319	+ \$479
Fabric/Vinyl Grade 5	FG5/VG5	+ \$482	+ \$723
Fabric/Vinyl Grade 6	FG6/VG6	+ \$667	+ \$1,001
Fabric/Vinyl Grade 7	FG7/VG7	+ \$853	+ \$1,279
Leather Grade 1	LG1	+ \$696	+ \$1,044
COL	COL	+ \$812	+ \$1,218
Leather Grade 2	LG2	+ \$812	+ \$1,218
Leather Grade 3	LG3	+ \$928	+ \$1,392

Upholstery prices apply to both 21" and 24" models.

If different fabrics are selected for the seat and back, add the multi-upholstery upcharge as well, even if the fabrics are the same grade.

Please reference the Textile Reference Guide for pricing on fabric over grade 7 and leather over grade 3. Additional CAL 133 information can be found on page 10.

### 6. Options

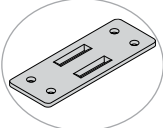
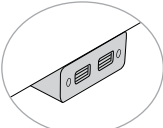
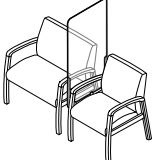
Ganging Brackets	Code	Price	
Ganging Brackets	XGV	+ \$103	
Power Options	Code	Price	
Power, Left	PFL	+ \$250	
Power, Right	PFR	+ \$250	
Sector Seating Screen	3097 XRX	+ \$460	

### 7. Packaging

Packaging	Code	Price
Fully Assembled in a Carton	P1	+ \$0

### 2-SEAT SPECIFICATIONS

Model:	21"	24"
<b>Dimensions</b>		
Height	34.5"	34.5"
Width	46.39" (AC0) 47.28" (AC1)	52.39" (AC0) 53.28" (AC1)
Depth	26.5"	26.5"
Arm Height (Height of Arms From Floor)	25.75"	25.75"
Arm Height (From Seat to Top of Arm)	7.25"	7.25"
Width Between Arms	42.64" (AC0) 20.75" (AC1)	48.64" (AC0) 23.75" (AC1)
Seat Width	21.75"	24.75"
Seat Depth	19"	19"
Seat Height	18.5"	18.5"
Back Height	18.5"	18.5"
<b>Materials</b>		
COM (Fully Upholstered)	3.8 yd	4.3 yd
COM (Multi-Upholstery)		
Seat Only	1.9 yd	2.2 yd
Back Only	2.1 yd	3.1 yd
COL (Fully Upholstered)	58 sq ft	86 sq ft
<b>Weight and Capacity</b>		
Weight	81 lb (FM3+AC0) 85 lb (FM3+AC1) 76 lb (FM1/FM2+AC0) 79 lb (FM1/FM2+AC1)	84 lb (FM3+AC0) 88 lb (FM3+AC1) 79 lb (FM1/FM2+AC0) 82 lb (FM1/FM2+AC1)
Weight Capacity	525 lb	525 lb
Warranty		

Metal frame (FM3). Beech wood frame (FM2), Maple wood frame (FM2).  
No center arms (AC0). Center arm (AC1).

Yardage requirements for COM and COL are for solid and non-directional fabrics.  
Additional material may be required for larger repeating patterns.

### 3-SEAT SPECIFICATIONS

Model:	21"	24"
<b>Dimensions</b>		
Height	34.5"	34.5"
Width	68.27" (AC0) 70.03" (AC1)	77.27" (AC0) 79.03" (AC1)
Depth	26.5"	26.5"
Arm Height (Height of Arms From Floor)	25.75"	25.75"
Arm Height (From Seat to Top of Arm)	7.25"	7.25"
Width Between Arms	64.52" (AC0) 20.75" (AC1)	73.52" (AC0) 23.75" (AC1)
Seat Width	21.75"	24.75"
Seat Depth	19"	19"
Seat Height	18.5"	18.5"
Back Height	18.5"	18.5"
<b>Materials</b>		
COM (Fully Upholstered)	5.6 yd	5.9 yd
COM (Multi-Upholstery)		
Seat Only	3 yd	3 yd
Back Only	3.1 yd	4.7 yd
COL (Fully Upholstered)	88.2 sq ft	93 sq ft
<b>Weight and Capacity</b>		
Weight	104 lb (FM3+AC0) 110 lb (FM3+AC1) 99 lb (FM1/FM2+AC0) 105 lb (FM1/FM2+AC1)	109 lb (FM3+AC0) 117 lb (FM3+AC1) 104 lb (FM1/FM2+AC0) 110 lb (FM1/FM2+AC1)
Weight Capacity	750 lb	750 lb
Warranty		

Metal frame (FM3). Beech wood frame (FM2), Maple wood frame (FM3).  
No center arms (AC0). Center arms (AC1).

Yardage requirements for COM and COL are for solid and non-directional fabrics.  
Additional material may be required for larger repeating patterns.



Metal 3-Seat

# Aviera

## PRECONFIGURED TANDEM MULTISEATING

### *Comfort that lasts.*

Whether lobby, lounge, welcoming or waiting, you can rest easy with supremely comfortable do-it-all seating for your public spaces. Aviera makes it easy to configure endlessly and effortlessly—across an entire collection—with worry-free design and lasting durability, including metal or wood frames that feature an integrated steel structure. Discover an industry-leading seating solution and get peace-of-mind for any project.



*Metal 2-Seat*

**EFFECTIVE DECEMBER 1, 2021**

### Featured Models

#### **METAL 2-SEAT :: \$2,682**

Metal frame, 21" seat, open arms, polyurethane arm caps, multi-upholstery, grade 4 vinyl seat and grade 5 vinyl back

#### **WOOD 2-SEAT :: \$2,975**

Maple frame, 21" seat, open arms, no arm caps, multi-upholstery, grade 2 vinyl seat and grade 7 fabric back

#### **METAL 3-SEAT :: \$4,097**

Metal frame, 21" seat, open arms, polyurethane arm caps, multi-upholstery, grade 1 vinyl seat and grade 7 vinyl back

## PRECONFIGURED TANDEM MULTISEATING

### Features

- Easy ingress and egress with waterfall seat design
- Clean-out space
- Steel-frame construction with metal-to-metal connections
- Beveled, wall-saving frame design
- Two frame materials: Durable aluminum frame or wood frame with silver ion anti-microbial finish
- Three metal frame finishes or four wood frame finishes
- Polyurethane, wood or solid surface arm caps
- Replaceable parts including seat, back, arms, arm caps and arm insets.
- 500 lb weight capacity (per seat) warranty

### 1. Product

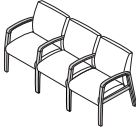
Model	Code	Price	
Aviera 2-Seat Preconfigured	VRC SN2	\$1,856	
Aviera 3-Seat Preconfigured	VRC SN3	\$2,705	

### 2. Frame

Frame Material	Code	Price	
Metal	FM3	+ \$0	
<b>Wood</b>			
Beech 2-Seat	FM2	+ \$15	
Beech 3-Seat	FM2	+ \$20	
Maple 2-Seat	FM1	+ \$102	
Maple 3-Seat	FM1	+ \$136	
Frame Finish	Code	Price	
<b>For Metal Frame</b>			
Silver Metallic	FCM1	+ \$0	
Graphite	FCM2	+ \$0	
Taupe	FCM3	+ \$0	
<b>For Wood Frame</b>			
Clear Maple	FCW1	+ \$0	
Medium Cherry	FCW2	+ \$0	
Amber Mahogany	FCW3	+ \$0	
Espresso	FCW4	+ \$0	
Stain-to-Match	STM	+ \$70	
New Custom Stain	STL	+ \$275	



Frame Options	Code	Price	
Protective Guard Clear Tape, 2-Seat	FX1	+ \$126	
Protective Guard Clear Tape, 3-Seat	FX1	+ \$168	

*New Custom Stain (STL): If stain is not in our library, add this one-time \$275 net fee in addition to the \$70 stain-to-match (STM) cost.*

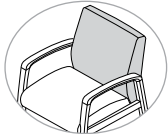
### 3. Back

Back Height	Code	Price	
Guest Back	BH1	+ \$0	

## 4. Seat

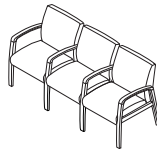
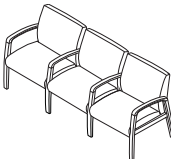
Seat Width	Code	Price	
21", 2-Seat	SW21	+ \$0	
24", 2-Seat	SW24	+ \$110	
21", 3-Seat	SW21	+ \$0	
24", 3-Seat	SW24	+ \$165	

## 5. Arms

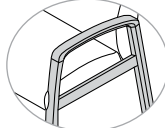
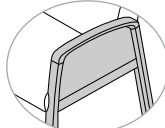
Arm Type	Code	Price	
Open Arm	AT1	+ \$0	
Upholstered Arm, 2-Seat	AT2	+ \$129	
Upholstered Arm, 3-Seat	AT2	+ \$172	

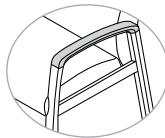
Arm Cap Material	Code	Price	
<b>For Metal Frame</b>			
Polyurethane	ACP4	+ \$0	
Wood, 2-Seat	ACP3	+ \$120	
Wood, 3-Seat	ACP3	+ \$160	
Solid Surface, 2-Seat	ACP5	+ \$675	
Solid Surface, 3-Seat	ACP5	+ \$900	

*Upholstered arm textile will match seat textile.*

## PRECONFIGURED TANDEM MULTISEATING

## 5. Arms (Cont.)

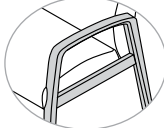
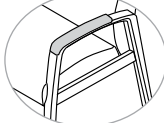
Arm Cap Material	Code	Price	
<b>For Wood Frame</b>			
No Arm Cap	ACP0	+ \$0	
Polyurethane, 2-Seat	ACP2	+ \$180	
Polyurethane, 3-Seat	ACP2	+ \$240	

Arm Cap Finish	Code	Price	
<b>For Polyurethane Arm Caps</b>			
Black	RMC3	+ \$0	
Fog	RMC4	+ \$0	
Dark Grey	RMC5	+ \$0	
<b>For Wood Arm Caps</b>			
Clear Maple	FCW1	+ \$0	
Medium Cherry	FCW2	+ \$0	
Amber Mahogany	FCW3	+ \$0	
Espresso	FCW4	+ \$0	
Stain-to-Match	STM	+ \$70	
New Custom Stain	STL	+ \$275	

<b>For Solid Surface Arm Caps</b>			
Designer White	TSS2	+ \$0	

*Upholstered arm textile will match seat textile.*

*New Custom Stain (STL): If stain is not in our library, add this one-time \$275 net fee in addition to the \$70 stain-to-match (STM) cost.*

## 6. Material

Protection	Code	Price	
<b>Fire Retardancy</b>		2-Seat	3-Seat
CAL 133	UCAL	+ \$200	+ \$300
Cleaning	Code	Price	
<b>Moisture Barrier</b>		2-Seat	3-Seat
Seat Only	UM2	+ \$130	+ \$195
Back Only	UM1	+ \$130	+ \$195
Seat and Back	UM3	+ \$260	+ \$390

# AVIERA PRECONFIGURED

EFFECTIVE DECEMBER 1, 2021 | GSA SIN #: 33721

## 6. Material (Cont.)

Fully Upholstered	Code	Price	
Seat and Back Textile		2-Seat	3-Seat
Fabric/Vinyl Grade 1	FG1/VG1	+ \$0	+ \$0
COM	COM	+ \$120	+ \$180
Fabric/Vinyl Grade 2	FG2/VG2	+ \$120	+ \$180
Fabric/Vinyl Grade 3	FG3/VG3	+ \$300	+ \$450
Fabric/Vinyl Grade 4	FG4/VG4	+ \$550	+ \$825
Fabric/Vinyl Grade 5	FG5/VG5	+ \$830	+ \$1,245
Fabric/Vinyl Grade 6	FG6/VG6	+ \$1,150	+ \$1,725
Fabric/Vinyl Grade 7	FG7/VG7	+ \$1,470	+ \$2,205
Leather Grade 1	LG1	+ \$1,200	+ \$1,800
COL	COL	+ \$1,400	+ \$2,100
Leather Grade 2	LG2	+ \$1,400	+ \$2,100
Leather Grade 3	LG3	+ \$1,600	+ \$2,400
Multi-Upholstery	Code	Price	
		2-Seat	3-Seat
Multi-Upholstery Upcharge	UMU	+ \$113	+ \$113
Seat Textile Only		2-Seat	3-Seat
Fabric/Vinyl Grade 1	FG1/VG1	+ \$0	+ \$0
COM	COM	+ \$51	+ \$76
Fabric/Vinyl Grade 2	FG2/VG2	+ \$51	+ \$76
Fabric/Vinyl Grade 3	FG3/VG3	+ \$126	+ \$189
Fabric/Vinyl Grade 4	FG4/VG4	+ \$231	+ \$347
Fabric/Vinyl Grade 5	FG5/VG5	+ \$349	+ \$523
Fabric/Vinyl Grade 6	FG6/VG6	+ \$483	+ \$725
Fabric/Vinyl Grade 7	FG7/VG7	+ \$618	+ \$927
Leather Grade 1	LG1	+ \$504	+ \$756
COL	COL	+ \$588	+ \$882
Leather Grade 2	LG2	+ \$588	+ \$882
Leather Grade 3	LG3	+ \$672	+ \$1,008

## PRECONFIGURED TANDEM MULTISEATING

## 6. Material (Cont.)

Multi-Upholstery	Code	Price	
Back Textile Only		2-Seat	3-Seat
Fabric/Vinyl Grade 1	FG1/VG1	+ \$0	+ \$0
COM	COM	+ \$70	+ \$105
Fabric/Vinyl Grade 2	FG2/VG2	+ \$70	+ \$105
Fabric/Vinyl Grade 3	FG3/VG3	+ \$174	+ \$261
Fabric/Vinyl Grade 4	FG4/VG4	+ \$319	+ \$479
Fabric/Vinyl Grade 5	FG5/VG5	+ \$482	+ \$723
Fabric/Vinyl Grade 6	FG6/VG6	+ \$667	+ \$1,001
Fabric/Vinyl Grade 7	FG7/VG7	+ \$853	+ \$1,279
Leather Grade 1	LG1	+ \$696	+ \$1,044
COL	COL	+ \$812	+ \$1,218
Leather Grade 2	LG2	+ \$812	+ \$1,218
Leather Grade 3	LG3	+ \$928	+ \$1,392

Upholstery prices apply to both 21" and 24" models.

If different fabrics are selected for the seat and back, add the multi-upholstery upcharge as well, even if the fabrics are the same grade.

Please reference the *Textile Reference Guide* for pricing on fabric over grade 7 and leather over grade 3. Additional CAL 133 information can be found on page 10.

## 7. Options

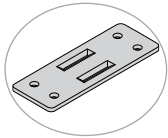
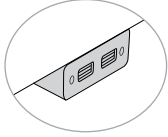
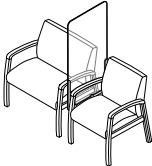
Ganging Brackets	Code	Price	
Ganging Brackets	XGV	+ \$103	
Power Options			
Power, Left	PFL	+ \$250	
Power, Right	PFR	+ \$250	
Sector Seating Screen	3097 XRX	+ \$460	

## 8. Packaging

Packaging	Code	Price	
Packaging Options		2-Seat	3-Seat
Final Assembly Required	P3	+ \$0	+ \$0
Fully Assembled in a Carton	P1	+ \$200	+ \$325

# AVIERA PRECONFIGURED

EFFECTIVE DECEMBER 1, 2021 | GSA SIN #: 33721

## PRECONFIGURED TANDEM MULTISEATING

### SPECIFICATIONS: 2-SEAT

Model:	21"	24"
<b>Dimensions</b>		
Height	34.5"	34.5"
Width	47.19"	53.19"
Depth	26.5"	26.5"
Arm Height (Height of Arms From Floor)	25.75"	25.75"
Arm Height (From Seat to Top of Arm)	7.25"	7.25"
Width Between Arms	20.75"	23.75"
Seat Width	21.75"	24.75"
Seat Depth	19"	19"
Seat Height	18.5"	18.5"
Back Height	18.5"	18.5"
<b>Materials</b>		
COM (Fully Upholstered)	3.8 yd	4.3 yd
COM (Multi-Upholstery)		
Seat Only	1.9 yd	2.2 yd
Back Only	2.1 yd	3.1 yd
COL (Fully Upholstered)	58 sq ft	86 sq ft
<b>Weight and Capacity</b>		
Weight	38 lb (FM3) 33 lb (FM1/FM2)	40 lb (FM3) 35 lb (FM1/FM2)
Weight Capacity (Per Seat) Warranty	500 lb	500 lb

Metal frame (FM3), Beech wood frame (FM2), Maple wood frame (FM1).  
Yardage requirements for COM and COL are for solid and non-directional fabrics.  
Additional material may be required for larger repeating patterns.

### SPECIFICATIONS: 3-SEAT

Model:	21"	24"
<b>Dimensions</b>		
Height	34.5"	34.5"
Width	69.85"	78.85"
Depth	26.5"	26.5"
Arm Height (Height of Arms From Floor)	25.75"	25.75"
Arm Height (From Seat to Top of Arm)	7.25"	7.25"
Width Between Arms	20.75"	20.75"
Seat Width	21.75"	24.75"
Seat Depth	19"	19"
Seat Height	18.5"	18.5"
Back Height	18.5"	18.5"
<b>Materials</b>		
COM (Fully Upholstered)	5.6 yd	5.9 yd
COM (Multi-Upholstery)		
Seat Only	3 yd	3 yd
Back Only	3.1 yd	4.7 yd
COL (Fully Upholstered)	88.2 sq ft	93 sq ft
<b>Weight and Capacity</b>		
Weight	99 lb (FM3) 89 lb (FM1/FM2)	104 lb (FM3) 94 lb (FM1/FM2)
Weight Capacity (Per Seat) Warranty	500 lb	500 lb

Metal frame (FM3), Beech wood frame (FM2), Maple wood frame (FM1).  
Yardage requirements for COM and COL are for solid and non-directional fabrics.  
Additional material may be required for larger repeating patterns.



Wood 2-Seat

# Aviera

## START/CENTER/END TANDEM MULTISEATING

### *Comfort that lasts.*

Whether lobby, lounge, welcoming or waiting, you can rest easy with supremely comfortable do-it-all seating for your public spaces. Aviera makes it easy to configure endlessly and effortlessly—across an entire collection—with worry-free design and lasting durability, including metal or wood frames that feature an integrated steel structure. Discover an industry-leading seating solution and get peace-of-mind for any project.



*Metal 4-Seat*

**EFFECTIVE DECEMBER 1, 2021**

### Featured Models

#### **METAL 3-SEAT :: \$3,951**

One 21" start, one 30" center, one 21" end, metal frame, open arms, polyurethane arm caps, multi-upholstery, grade 3 vinyl seat and back

#### **METAL 4-SEAT :: \$4,755**

One 21" start, two 21" centers, one 30" end, metal frame, open arms, polyurethane arm caps, multi-upholstery, grade 2 vinyl seat and back

#### **WOOD 5-SEAT :: \$6,539**

One 21" start, three 21" centers, one 30" end, maple frame, open arms, no arm caps, multi-upholstery, grade 3 vinyl seat and back





## START/CENTER/END TANDEM MULTISEATING

### Features

- Start/center/end multiseating is the most versatile and is designed for configurations requiring more than three seats
- Easy ingress and egress with 18.5" seat height and waterfall seat design
- Clean-out space
- Steel-frame construction with metal-to-metal connections
- Beveled, wall-saving frame design
- Two frame materials: Durable aluminum frame or wood frame with silver ion anti-microbial finish
- Three metal frame finishes or four wood frame finishes
- Polyurethane, wood or solid surface arm caps
- Replaceable parts including seat, back, arms, arm caps and arm insets
- 21"/24" seat: 500 lb weight capacity warranty  
30"/44" seat: 750 lb weight capacity warranty

### 1. Product

Model	Code	Price	
Start	VRM FS4	\$958	
Center	VRM FS5	\$929	
End	VRM FS6	\$929	

### 2. Frame



Frame Material	Code	Price	
Metal	FM3	+ \$0	
<b>Wood</b>			
Beech, Start	FM2	+ \$10	
Maple, Start	FM1	+ \$68	
Beech, Center or End	FM2	+ \$5	
Maple, Center or End	FM1	+ \$34	
Frame Finish	Code	Price	
<b>For Metal Frame</b>			
Silver Metallic	FCM1	+ \$0	
Graphite	FCM2	+ \$0	
Taupe	FCM3	+ \$0	
<b>For Wood Frame</b>			
Clear Maple	FCW1	+ \$0	
Medium Cherry	FCW2	+ \$0	
Amber Mahogany	FCW3	+ \$0	
Espresso	FCW4	+ \$0	
Stain-to-Match	STM	+ \$70	
New Custom Stain	STL	+ \$275	
Frame Options	Code	Price	
Protective Guard Clear Tape, Start	FX1	+ \$84	
Protective Guard Clear Tape, Center/End	FX1	+ \$42	

*New Custom Stain (STL): If stain is not in our library, add this one-time \$275 net fee in addition to the \$70 stain-to-match (STM) cost.*

# AVIERA START/CENTER/END

EFFECTIVE DECEMBER 1, 2021 | GSA SIN #: 33721

## 3. Seat

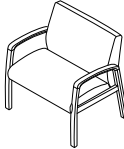
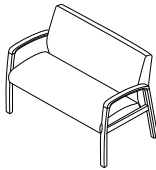
Seat Width	Code	Price	
21"	SW21	+ \$0	
24"	SW24	+ \$55	
<b>Bariatric</b>			
30"	SW30	+ \$275	
44"	SW44	+ \$500	

## 4. Back

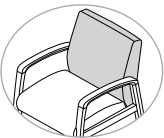
Back Height	Code	Price	
Guest Back	BH1	+ \$0	

## 5. Arms

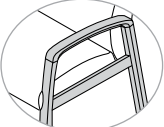
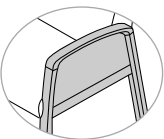
Arm Type	Code	Price	
Open Arm	AT1	+ \$0	
Upholstered Arm, Start	AT2	+ \$86	
Upholstered Arm, Center or End	AT2	+ \$43	

## START/CENTER/END TANDEM MULTISEATING

## 5. Arms (Cont.)

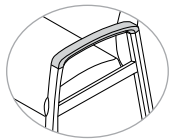
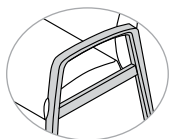
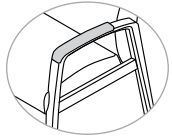
Arm Cap Material	Code	Price	
<b>For Metal Frame</b>			
Polyurethane	ACP4	+ \$0	
Wood, Start	ACP3	+ \$80	
Wood, Center/End	ACP3	+ \$40	
Solid Surface	ACP5	+ \$450	
Solid Surface, Center/End	ACP5	+ \$225	
<b>For Wood Frame</b>			
No Arm Cap	ACP0	+ \$0	
Polyurethane, Start	ACP2	+ \$120	
Polyurethane, Center/End	ACP2	+ \$60	
Arm Cap Finish	Code	Price	
<b>For Polyurethane Arm Caps</b>			
Black	RMC3	+ \$0	
Fog	RMC4	+ \$0	
Dark Grey	RMC5	+ \$0	
<b>For Wood Arm Caps</b>			
Clear Maple	FCW1	+ \$0	
Medium Cherry	FCW2	+ \$0	
Amber Mahogany	FCW3	+ \$0	
Espresso	FCW4	+ \$0	
Stain-to-Match	STM	+ \$70	
New Custom Stain	STL	+ \$275	
<b>For Solid Surface Arm Caps</b>			
Designer White	TSS2	+ \$0	

*New Custom Stain (STL): If stain is not in our library, add this one-time \$275 net fee in addition to the \$70 stain-to-match (STM) cost.*

## START/CENTER/END TANDEM MULTISEATING

### 6. Material

Protection	Code	Price	
Fire Retardancy		21"/24"	30"/44"
CAL 133	UCAL	+ \$100	+ \$100
Cleaning	Code	Price	
Moisture Barrier		21"/24"	30"/44"
Seat Only	UM2	+ \$65	+ \$65
Back Only	UM1	+ \$65	+ \$65
Seat and Back	UM3	+ \$130	+ \$130
Fully Upholstered	Code	Price	
Seat and Back Textile		21"/24"	30"/44"
Fabric/Vinyl Grade 1	FG1/VG1	+ \$0	+ \$0
COM	COM	+ \$60	+ \$100
Fabric/Vinyl Grade 2	FG2/VG2	+ \$60	+ \$100
Fabric/Vinyl Grade 3	FG3/VG3	+ \$150	+ \$220
Fabric/Vinyl Grade 4	FG4/VG4	+ \$275	+ \$365
Fabric/Vinyl Grade 5	FG5/VG5	+ \$415	+ \$525
Fabric/Vinyl Grade 6	FG6/VG6	+ \$575	+ \$705
Fabric/Vinyl Grade 7	FG7/VG7	+ \$735	+ \$885
Leather Grade 1	LG1	+ \$600	+ \$685
COL	COL	+ \$700	+ \$805
Leather Grade 2	LG2	+ \$700	+ \$805
Leather Grade 3	LG3	+ \$800	+ \$1,005
Multi-Upholstery	Code	Price	
		21"/24"	30"/44"
Multi-Upholstery Upcharge	UMU	+ \$113	+ \$113
Seat Textile Only		21"/24"	30"/44"
Fabric/Vinyl Grade 1	FG1/VG1	+ \$0	+ \$0
COM	COM	+ \$26	+ \$42
Fabric/Vinyl Grade 2	FG2/VG2	+ \$26	+ \$42
Fabric/Vinyl Grade 3	FG3/VG3	+ \$63	+ \$93
Fabric/Vinyl Grade 4	FG4/VG4	+ \$116	+ \$154
Fabric/Vinyl Grade 5	FG5/VG5	+ \$175	+ \$221
Fabric/Vinyl Grade 6	FG6/VG6	+ \$242	+ \$297
Fabric/Vinyl Grade 7	FG7/VG7	+ \$309	+ \$372
Leather Grade 1	LG1	+ \$252	+ \$288
COL	COL	+ \$294	+ \$339
Leather Grade 2	LG2	+ \$294	+ \$339
Leather Grade 3	LG3	+ \$336	+ \$423

### 6. Material (Cont.)

Multi-Upholstery	Code	Price	
Back Textile Only		21"/24"	30"/44"
Fabric/Vinyl Grade 1	FG1/VG1	+ \$0	+ \$0
COM	COM	+ \$35	+ \$58
Fabric/Vinyl Grade 2	FG2/VG2	+ \$35	+ \$58
Fabric/Vinyl Grade 3	FG3/VG3	+ \$87	+ \$128
Fabric/Vinyl Grade 4	FG4/VG4	+ \$160	+ \$212
Fabric/Vinyl Grade 5	FG5/VG5	+ \$241	+ \$305
Fabric/Vinyl Grade 6	FG6/VG6	+ \$334	+ \$409
Fabric/Vinyl Grade 7	FG7/VG7	+ \$427	+ \$514
Leather Grade 1	LG1	+ \$348	+ \$398
COL	COL	+ \$406	+ \$467
Leather Grade 2	LG2	+ \$406	+ \$467
Leather Grade 3	LG3	+ \$464	+ \$583

If different fabrics are selected for the seat and back, add the multi-upholstery upcharge as well, even if the fabrics are the same grade.

Please reference the *Textile Reference Guide* for pricing on fabric over grade 7 and leather over grade 3. Additional CAL 133 information can be found on page 10.

### 7. Power

Power Options	Code	Price
Power, Left	PFL	+ \$250
Power, Right	PFR	+ \$250

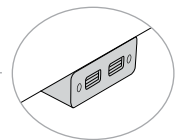

### 8. Packaging

Packaging	Code	Price
Fully Assembled in a Carton	P1	+ \$0

## START/CENTER/END TANDEM MULTISEATING

### SPECIFICATIONS

Model:	21"	24"
Height	34.5"	34.5"
Width	24.5" (FS4) 22.66" (FS5/FS6)	27.5" (FS4) 25.66" (FS5/FS6)
Depth	26.5"	26.5"
Arm Height (Height of Arms From Floor)	25.75"	25.75"
Arm Height (From Seat to Top of Arm)	7.25"	7.25"
Width Between Arms	20.75"	23.75"
Seat Width	21.75"	24.75"
Seat Depth	19"	19"
Seat Height	18.5"	18.5"
Back Height	18.5"	18.5"
Weight	38 lb (FM3) 33 lb (FM1/FM2)	40 lb (FM3) 35 lb (FM1/FM2)
COM (Fully Upholstered)	1.9 yd	1.9 yd
COM (Multi-Upholstery)		
Seat Only	1.2 yd	1.2 yd
Back Only	1.1 yd	1.6 yd
COL (Fully Upholstered)	29.4 sq ft	43.4 sq ft
Weight Capacity Warranty	500 lb	500 lb

Start (FS4), Center (FS5), End (FS6), Metal frame (FM3), Beech wood frame (FM1), Maple wood frame (FM2).

Yardage requirements for COM and COL are for solid and non-directional fabrics. Additional material may be required for larger repeating patterns.

### SPECIFICATIONS: BARIATRIC SIZES

Model:	30"	44"
Height	34.5"	34.5"
Width	33.5" (FM4) 31.66" (FS5/FS6)	47.5" (FM4) 45.66" (FS5/FS6)
Depth	26.5"	26.5"
Arm Height (Height of Arms From Floor)	25.75"	25.75"
Arm Height (From Seat to Top of Arm)	7.25"	7.25"
Width Between Arms	29.75"	43.75"
Seat Width	30.75"	44.75"
Seat Depth	19"	19"
Seat Height	18.5"	18.5"
Back Height	18.5"	18.5"
Weight	50 lb (FM3+BH1) 45 lb (FM1/FM2+BH1)	77 lb (FM3+BH1) 73 lb (FM1/FM2+BH1)
COM (Fully Upholstered)	3.1 yd	3.4 yd
COM (Multi-Upholstery)		
Seat Only	1.2 yd	1.6 yd
Back Only	1.9 yd	1.9 yd
COL (Fully Upholstered)	47.6 sq ft	50.4 sq ft
Weight Capacity Warranty	750 lb	750 lb

Start (FS4), Center (FS5), End (FS6), Metal frame (FM3), Beech wood frame (FM1), Maple wood frame (FM2).

Yardage requirements for COM and COL are for solid and non-directional fabrics. Additional material may be required for larger repeating patterns.



Metal 5-Seat

# Aviera

## LINKING TABLES

### *High traffic. Low stress.*

Tables are like bridges joining chairs and multi-seating elements. Connect like items together or mix them up. For instance, a table can link to a guest or patient chair on one side and a Preconfigured, freespan, start or end element on the other. In a start/center/end configuration, a table must connect to either a start or an end. End tables have two legs and 90° radius and square tables have one leg.



*Wood Center Linking Table*

**EFFECTIVE DECEMBER 1, 2021**

## Featured Models

### **WOOD CENTER LINKING TABLE :: \$712**

Center linking table, maple, wood leg, maple wood veneer top and edge

### **METAL LEG SQUARE CORNER TABLE :: \$867**

Square 90-degree corner table, metal leg, laminate top, polymer edge finish



### **SOLID SURFACE END TABLE :: \$1,267**

End table, maple, metal leg and base, solid surface top and edge

## Features

- Connects to Aviera Guest, Patient, and Multiseating options
- Four wood finishes and nine laminate colors
- Veener and solid surface top options

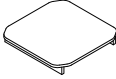
### 1. Appearance

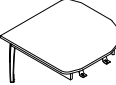
Table Type	Code	Price	
Center	VRL TTL1	\$712	
End	VRL TTL3	\$872	
Round 90-Degree Corner	VRL TTL4	\$897	
Square 90-Degree Corner	VRL TTL5	\$997	

### 2. Leg and Base

Leg and Base Material	Code	Price	
Wood	LM1	+ \$0	
Metal	LM2	+ \$0	
Leg and Base Finish	Code	Price	
Wood Finish			
Clear Maple	FCW1	+ \$0	
Medium Cherry	FCW2	+ \$0	
Amber Mahogany	FCW3	+ \$0	
Espresso	FCW4	+ \$0	
Stain-to-Match	STM	+ \$70	
New Custom Stain	STL	+ \$275	

*New Custom Stain (STL): If stain is not in our library, add this one-time \$275 net fee in addition to the \$70 stain-to-match (STM) cost.*

## LINKING TABLES

### 2. Leg and Base (Cont.)

Leg and Base Finish	Code	Price	
Metal Finish			
Silver Metallic	FCM1	+ \$0	
Graphite	FCM2	+ \$0	
Taupe	FCM3	+ \$0	
Leg Options	Code	Price	
Protective Guard Clear Tape (Round or Square Table Type)	LX1	+ \$21	
Protective Guard Clear Tape (End Table Type)	LX1	+ \$42	

### 3. Tabletop

Tabletop and Edge Material	Code	Price	
Wood and Laminate			
Laminate Top With Polymer Edge	TM3	- \$130	
Beech Wood Veneer Top and Edge	TM2	- \$60	
Maple Wood Veneer Top and Edge	TM1	+ \$0	
Solid Surface			
Center or End Table	TM4	+ \$395	
Corner Table	TM4	+ \$640	
Tabletop Finish	Code	Price	
Laminate Color			
Fusion Maple Laminate	TL1	+ \$0	
Huntington Maple Laminate	TL2	+ \$0	
Cafelle Laminate	TL4	+ \$0	
Shaker Cherry Laminate	TL5	+ \$0	
Fonthill Pear Laminate	TL6	+ \$0	
Brighton Walnut Laminate	TL7	+ \$0	
Khaki Brown Laminate	TL9	+ \$0	
Slate Laminate	TL10	+ \$0	
Black Laminate	TL12	+ \$0	
Laminate-to-Match (10+ Units)	LMM	+ \$0	
Laminate-to-Match (Under 10 Units)	LMM	+ \$300	

### 3. Tabletop (Cont.)

Tabletop Finish	Code	Price
<b>Wood Finish</b>		
Clear Maple	FCW1	+ \$0
Medium Cherry	FCW2	+ \$0
Amber Mahogany	FCW3	+ \$0
Espresso	FCW4	+ \$0
Stain-to-Match	STM	+ \$70
New Custom Stain	STL	+ \$275
<b>Solid Surface Finish</b>		
Designer White	Tss2	+ \$0
Table Edge Finish	Code	Price
<b>Polymer Finish</b>		
Fusion Maple Polymer	TP1	+ \$0
Huntington Maple Polymer	TP2	+ \$0
Cafelle Polymer	TP4	+ \$0
Mocha Polymer	TP5	+ \$0
Fonthill Pear Polymer	TP6	+ \$0
Brighton Walnut Polymer	TP7	+ \$0
Khaki Brown Polymer	TP9	+ \$0
Slate Polymer	TP10	+ \$0
Black Polymer	TP12	+ \$0
Polymer-to-Match	PTM	+ \$0

*New Custom Stain (STL): If stain is not in our library, add this one-time \$275 net fee in addition to the \$70 stain-to-match (STM) cost.*

*If laminate top is selected, wood finish will still need to be selected in addition to laminate color. Wood finish is applied to visible understructure.*

*Polymer finish pairs with laminate top (TM3) only.*

### LINKING TABLES

### 4. Packaging

Packaging	Code	Price
Knocked Down	P7	+ \$0

### SPECIFICATIONS

Model:	VRL TTL3 End	VRL TTL1 Center	VRL TTL5 Square 90° Corner	VRL TTL4 Round 90° Corner
Height (From Floor)	16"	16"	16"	16"
Width	21"	22"	28.4"	31"
Depth	22"	22"	28.4"	31"
Weight (Complete Assembly)	11 lb	11 lb	18 lb	18 lb
Weight (Tabletop)	6.5 lb	6.5 lb	15 lb	15 lb



Solid Surface End Table

# Aviera

## REPLACEMENT SEATING PARTS

### Replacement Parts: Arms

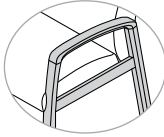
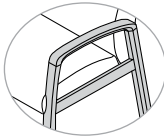
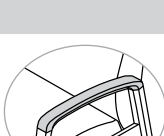
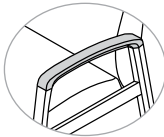
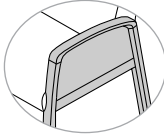
Part	Price	
<b>Metal Arm</b>		
Open Metal Arm, No Arm Cap	\$180	
Open Metal Arm, With Polyurethane Arm Cap	\$240	
Open Metal Arm, With Wood Arm Cap	\$280	
Open Metal Arm, With Solid Surface Arm Cap	\$680	
Open Beech Arm, No Arm Cap	\$190	
Open Maple Arm, No Arm Cap	\$210	
<b>Arm Caps</b>		
Polyurethane Arm Cap for Metal Frame	\$60	
Polyurethane Arm Cap for Wood Frame	\$160	
<b>Arm Inset</b>		
Upholstered Arm Inset	\$100	

Hip chair arms and Freespan center arms have separate pricing. All prices assume grade 1 textile. Please contact Customer Experience for additional information or to place an order.

### Replacement Part: Tables

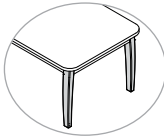
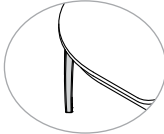
Part	Price	
<b>Table Legs</b>		
End Legs (2)	\$160	
Round or Square Corner Leg (1)	\$80	
Metal Leg (1)	\$120	

### Replacement Part: Tables (Cont.)

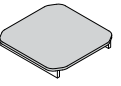
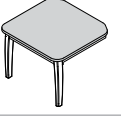
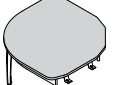
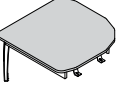
Part	Price	
<b>Laminate Top</b>		
Center	\$627	
End	\$680	
Round 90-Degree Corner	\$740	
Square 90-Degree Corner	\$840	

### Replacement Part: Upholstered

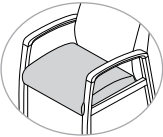
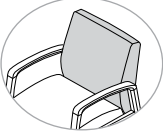
Part	Price	
<b>Seat</b>		
21"	\$428	
24"	\$455	
30"	\$557	
44"	\$664	
<b>Guest Back</b>		
21"	\$428	
24"	\$455	
30"	\$557	
44"	\$664	

All prices assume grade 1 textile. Please contact Customer Experience for additional information or to place an order.



# Cameo

## SEATING AND BENCHES

### *Design with distinction.*

Tap into timeless beauty with a new take on an old classic. Cameo™ dares to move past tufted, boxy and overly square designs—both in shape and attitude. This inspired collection from world-renowned architect and designer Claudio Bellini balances perfect proportions of slenderness with just enough contouring so that it feels as good as it looks.



**EFFECTIVE DECEMBER 1, 2021**

### Featured Models

#### **BENCH :: \$1,701**

Cameo single seat bench, chrome base finish, grade 1 textile

#### **ARMLESS SEAT :: \$1,882**

Cameo single seat lounge with no arms, charcoal base finish, grade 1 textile

#### **SEAT :: \$2,107**

Cameo single seat with dual arms and grade 1 textile

## Features

- Add a lightweight, modern look with slim ribbon leg design
- Promotes all-around comfort with contoured seat, back and arms
- Choose between single seat, 2-seater, and 3-seater seats and benches
- Design for traditional and modular configurations
- Create single-arm, dual-arm and armless configurations
- Charcoal, bronze or chrome sled-leg bases
- Designed by Claudio Bellini
- Weight capacity warranty: 400 lb for single-seater; 800 lb for 2- and 3-seater

### 1. Product

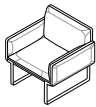
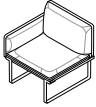
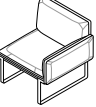
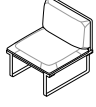
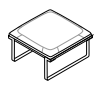
Model	Code	Price	
<b>Single Seat</b>			
Single Seat With Dual Arms	CAM SN1 FS8	\$2,107	
Single Seat With Right Arm	CAM SN1 FS10	\$1,995	
Single Seat With Left Arm	CAM SN1 FS12	\$1,995	
Single Seat Armless	CAM SN1 FS17	\$1,882	
Single Seat Bench	CAM SN1 FS2	\$1,451	

## SEATING AND BENCHES

### 1. Product (Cont.)

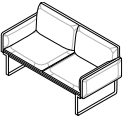
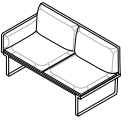
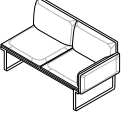
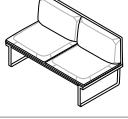
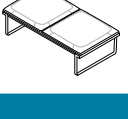
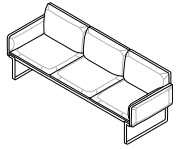
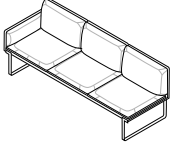
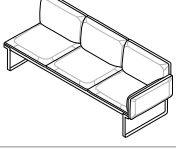
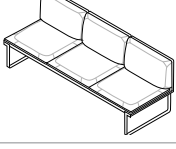
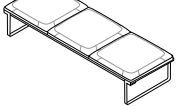
Model	Code	Price	
<b>2-Seater</b>			
2-Seater With Dual Arms	CAM SN2 FS8	\$3,175	
2-Seater With Right Arm	CAM SN2 FS10	\$3,062	
2-Seater With Left Arm	CAM SN2 FS12	\$3,062	
2-Seater Armless	CAM SN2 FS17	\$2,950	
2-Seater Bench	CAM SN2 FS2	\$1,956	
<b>3-Seater</b>			
3-Seater With Dual Arms	CAM SN3 FS8	\$4,082	
3-Seater With Right Arm	CAM SN3 FS10	\$3,970	
3-Seater With Left Arm	CAM SN3 FS12	\$3,970	
3-Seater Armless	CAM SN3 FS17	\$3,857	
3-Seater Bench	CAM SN3 FS2	\$2,864	

## SEATING AND BENCHES

### 2. Base

Metal Finish	Code	Price
Charcoal	BF04	+ \$0
Bronze	BF05	+ \$0
Chrome	BF06	+ \$250

### 3. Material

Protection	Code	Price		
<b>Fire Retardancy: Seats</b>		<b>1 Seat</b>	<b>2 Seats</b>	<b>3 Seats</b>
CAL 133	UCAL	+ \$262	+ \$377	+ \$494
<b>Fire Retardancy: Benches</b>		<b>1 Seat</b>	<b>2 Seats</b>	<b>3 Seats</b>
CAL 133	UCAL	+ \$262	+ \$377	+ \$494
Cleaning	Code	Price		
<b>Moisture Barrier: Seats</b>		<b>1 Seat</b>	<b>2 Seats</b>	<b>3 Seats</b>
Seat Only	UM2	+ \$59	+ \$118	+ \$177
Back Only	UM1	+ \$59	+ \$118	+ \$177
Seat and Back	UM3	+ \$118	+ \$236	+ \$354
<b>Moisture Barrier: Benches</b>		<b>1 Seat</b>	<b>2 Seats</b>	<b>3 Seats</b>
Seat Only	UM2	+ \$59	+ \$118	+ \$177
Fully Upholstered	Code	Price		
<b>Seat, Dual Arms</b>		<b>1 Seat</b>	<b>2 Seats</b>	<b>3 Seats</b>
Fabric/Vinyl Grade 1	FG1/VG1	+ \$0	+ \$0	+ \$0
COM	COM	+ \$143	+ \$224	+ \$283
Fabric/Vinyl Grade 2	FG2/VG2	+ \$143	+ \$224	+ \$283
Fabric/Vinyl Grade 3	FG3/VG3	+ \$222	+ \$348	+ \$441
Fabric/Vinyl Grade 4	FG4/VG4	+ \$318	+ \$498	+ \$630
Fabric/Vinyl Grade 5	FG5/VG5	+ \$477	+ \$747	+ \$945
Fabric/Vinyl Grade 6	FG6/VG6	+ \$636	+ \$996	+ \$1,260
Fabric/Vinyl Grade 7	FG7/VG7	+ \$795	+ \$1,245	+ \$1,575
Leather Grade 1	LG1	+ \$1,575	+ \$2,475	+ \$2,850
COL	COL	+ \$1,995	+ \$3,135	+ \$3,610
Leather Grade 2	LG2	+ \$1,995	+ \$3,135	+ \$3,610
Leather Grade 3	LG3	+ \$2,520	+ \$3,960	+ \$4,560

### 3. Material (Cont.)

Fully Upholstered (Cont.)	Code	Price		
<b>Seat, Single Arm</b>		<b>1 Seat</b>	<b>2 Seats</b>	<b>3 Seats</b>
Fabric/Vinyl Grade 1	FG1/VG1	+ \$0	+ \$0	+ \$0
COM	COM	+ \$108	+ \$189	+ \$243
Fabric/Vinyl Grade 2	FG2/VG2	+ \$108	+ \$189	+ \$243
Fabric/Vinyl Grade 3	FG3/VG3	+ \$168	+ \$294	+ \$378
Fabric/Vinyl Grade 4	FG4/VG4	+ \$240	+ \$420	+ \$540
Fabric/Vinyl Grade 5	FG5/VG5	+ \$360	+ \$630	+ \$810
Fabric/Vinyl Grade 6	FG6/VG6	+ \$480	+ \$840	+ \$1,080
Fabric/Vinyl Grade 7	FG7/VG7	+ \$600	+ \$1,050	+ \$1,350
Leather Grade 1	LG1	+ \$1,200	+ \$2,175	+ \$2,625
COL	COL	+ \$1,520	+ \$2,755	+ \$3,325
Leather Grade 2	LG2	+ \$1,520	+ \$2,755	+ \$3,325
Leather Grade 3	LG3	+ \$1,920	+ \$3,480	+ \$4,200
<b>Seat, Armless</b>		<b>1 Seat</b>	<b>2 Seats</b>	<b>3 Seats</b>
Fabric/Vinyl Grade 1	FG1/VG1	+ \$0	+ \$0	+ \$0
COM	COM	+ \$81	\$162	+ \$216
Fabric/Vinyl Grade 2	FG2/VG2	+ \$81	\$162	+ \$216
Fabric/Vinyl Grade 3	FG3/VG3	+ \$126	\$252	+ \$336
Fabric/Vinyl Grade 4	FG4/VG4	+ \$180	\$360	+ \$480
Fabric/Vinyl Grade 5	FG5/VG5	+ \$270	\$540	+ \$720
Fabric/Vinyl Grade 6	FG6/VG6	+ \$360	\$720	+ \$960
Fabric/Vinyl Grade 7	FG7/VG7	+ \$450	\$900	+ \$1,200
Leather Grade 1	LG1	+ \$900	\$1,875	+ \$2,400
COL	COL	+ \$1,140	\$2,375	+ \$3,040
Leather Grade 2	LG2	+ \$1,140	\$2,375	+ \$3,040
Leather Grade 3	LG3	+ \$1,440	\$3,000	+ \$3,840
<b>Bench</b>		<b>1 Seat</b>	<b>2 Seats</b>	<b>3 Seats</b>
Fabric/Vinyl Grade 1	FG1/VG1	+ \$0	+ \$0	+ \$0
COM	COM	+ \$43	+ \$86	+ \$108
Fabric/Vinyl Grade 2	FG2/VG2	+ \$43	+ \$86	+ \$108
Fabric/Vinyl Grade 3	FG3/VG3	+ \$67	+ \$134	+ \$168
Fabric/Vinyl Grade 4	FG4/VG4	+ \$96	+ \$192	+ \$240
Fabric/Vinyl Grade 5	FG5/VG5	+ \$144	+ \$288	+ \$360
Fabric/Vinyl Grade 6	FG6/VG6	+ \$192	+ \$384	+ \$480
Fabric/Vinyl Grade 7	FG7/VG7	+ \$240	+ \$480	+ \$600
Leather Grade 1	LG1	+ \$525	+ \$1,050	+ \$1,260
COL	COL	+ \$665	+ \$1,330	+ \$1,596
Leather Grade 2	LG2	+ \$665	+ \$1,330	+ \$1,596
Leather Grade 3	LG3	+ \$840	+ \$1,680	+ \$2,016

### 3. Material (Cont.)

Multi-Upholstery	Code	Price		
		1 Seat	2 Seats	3 Seats
Multi-Upholstery Upcharge	UMU	+ \$75	+ \$75	+ \$75
Upholstered Seat Only		1 Seat	2 Seats	3 Seats
Fabric/Vinyl Grade 1	FG1/VG1	+ \$0	+ \$0	+ \$0
COM	COM	+ \$46	+ \$92	+ \$108
Fabric/Vinyl Grade 2	FG2/VG2	+ \$46	+ \$92	+ \$108
Fabric/Vinyl Grade 3	FG3/VG3	+ \$71	+ \$143	+ \$168
Fabric/Vinyl Grade 4	FG4/VG4	+ \$102	+ \$204	+ \$240
Fabric/Vinyl Grade 5	FG5/VG5	+ \$153	+ \$306	+ \$360
Fabric/Vinyl Grade 6	FG6/VG6	+ \$204	+ \$408	+ \$480
Fabric/Vinyl Grade 7	FG7/VG7	+ \$255	+ \$510	+ \$600
Leather Grade 1	LG1	+ \$525	+ \$1,050	+ \$1,200
COL	COL	+ \$665	+ \$1,330	+ \$1,520
Leather Grade 2	LG2	+ \$665	+ \$1,330	+ \$1,520
Leather Grade 3	LG3	+ \$840	+ \$1,680	+ \$1,920
Upholstered Back Only		1 Seat	2 Seats	3 Seats
Fabric/Vinyl Grade 1	FG1/VG1	+ \$0	+ \$0	+ \$0
COM	COM	+ \$38	+ \$76	+ \$101
Fabric/Vinyl Grade 2	FG2/VG2	+ \$38	+ \$76	+ \$101
Fabric/Vinyl Grade 3	FG3/VG3	+ \$59	+ \$118	+ \$157
Fabric/Vinyl Grade 4	FG4/VG4	+ \$84	+ \$168	+ \$225
Fabric/Vinyl Grade 5	FG5/VG5	+ \$126	+ \$252	+ \$337
Fabric/Vinyl Grade 6	FG6/VG6	+ \$168	+ \$336	+ \$450
Fabric/Vinyl Grade 7	FG7/VG7	+ \$210	+ \$420	+ \$562
Leather Grade 1	LG1	+ \$420	+ \$840	+ \$1,125
COL	COL	+ \$532	+ \$1,064	+ \$1,425
Leather Grade 2	LG2	+ \$532	+ \$1,064	+ \$1,425
Leather Grade 3	LG3	+ \$672	+ \$1,344	+ \$1,800
Upholstered Single Arm Only		1 Seat	2 Seats	3 Seats
Fabric/Vinyl Grade 1	FG1/VG1	+ \$0	+ \$0	+ \$0
COM	COM	+ \$27	+ \$27	+ \$27
Fabric/Vinyl Grade 2	FG2/VG2	+ \$27	+ \$27	+ \$27
Fabric/Vinyl Grade 3	FG3/VG3	+ \$42	+ \$42	+ \$42
Fabric/Vinyl Grade 4	FG4/VG4	+ \$60	+ \$60	+ \$60
Fabric/Vinyl Grade 5	FG5/VG5	+ \$90	+ \$90	+ \$90
Fabric/Vinyl Grade 6	FG6/VG6	+ \$120	+ \$120	+ \$120
Fabric/Vinyl Grade 7	FG7/VG7	+ \$150	+ \$150	+ \$150
Leather Grade 1	LG1	+ \$300	+ \$300	+ \$300
COL	COL	+ \$380	+ \$380	+ \$380
Leather Grade 2	LG2	+ \$380	+ \$380	+ \$380
Leather Grade 3	LG3	+ \$480	+ \$480	+ \$480

### 3. Material (Cont.)

Multi-Upholstery	Code	Price		
		1 Seat	2 Seats	3 Seats
Upholstered Dual Arms Only				
Fabric/Vinyl Grade 1	FG1/VG1	+ \$0	+ \$0	+ \$0
COM	COM	+ \$54	+ \$54	+ \$54
Fabric/Vinyl Grade 2	FG2/VG2	+ \$54	+ \$54	+ \$54
Fabric/Vinyl Grade 3	FG3/VG3	+ \$84	+ \$84	+ \$84
Fabric/Vinyl Grade 4	FG4/VG4	+ \$120	+ \$120	+ \$120
Fabric/Vinyl Grade 5	FG5/VG5	+ \$180	+ \$180	+ \$180
Fabric/Vinyl Grade 6	FG6/VG6	+ \$240	+ \$240	+ \$240
Fabric/Vinyl Grade 7	FG7/VG7	+ \$300	+ \$300	+ \$300
Leather Grade 1	LG1	+ \$600	+ \$600	+ \$600
COL	COL	+ \$760	+ \$760	+ \$760
Leather Grade 2	LG2	+ \$760	+ \$760	+ \$760
Leather Grade 3	LG3	+ \$960	+ \$960	+ \$960

If different fabrics are selected for the seat and back, add the multiple upholstery upcharge (UMU) as well, even if the two fabrics are the same grade.

Please reference the Textile Reference Guide for pricing on fabric over grade 7 and leather over grade 3. Additional CAL 133 information can be found on page 10.

### 4. Miscellaneous

Accessories	Code	Price
Ganging Bracket	CAM XGV	+ \$52

One set of gangers (2 brackets) is included in this kit and can be installed on the left or right side of a seat or bench.

These two brackets are enough to gang two upholstered units together (benches or lounge units with or without an arm on the ganged side).

The inline table (CAMT TTL1) and the corner table (CAMT TTL4) are shipped standard with a total of two sets of gangers (4 brackets) to be supported between two upholstered units.

Order multiple quantities if ganging more than two pieces together.

Note: Ganging brackets are field installed.

### 5. Packaging

Packaging	Code	Price
Partially Assembled in Carton	P3	+ \$0

Leg ships unattached.

## SEATING AND BENCHES

### SPECIFICATIONS: SEATS WITH DUAL ARMS

Model:	CAM SN1 FS8 Single-Seat	CAM SN2 FS8 2-Seater	CAM SN3 FS8 3-Seater
<b>Dimensions</b>			
Height	30"	30"	30"
Width	32.75"	60"	86.6"
Depth	28"	28"	28"
Seat Depth	20.25"	20.25"	20.25"
Seat Height	16.75"	16.75"	16.75"
Back Height	13.25"	13.25"	13.25"
<b>Materials</b>			
COM (Single Upholstery)	5 yd	7.5 yd	10.5 yd
COM (Multi-Upholstery)			
Seat Only	1.75 yd	3.25 yd	5 yd
Back Only	1.6 yd	3 yd	4.75 yd
Arms Only	2.25 yd	2.25 yd	2.25 yd
COL (Single Upholstery)	99 sq ft	147 sq ft	170 sq ft
COL (Multi-Upholstery)			
Seat Only	31 sq ft	63 sq ft	80 sq ft
Back Only	31 sq ft	57 sq ft	75 sq ft
Arms Only	42 sq ft	42 sq ft	42 sq ft
<b>Weight and Capacity</b>			
Weight	75 lb	116 lb	169 lb
Weight Capacity Warranty	400 lb	800 lb	800 lb

### SPECIFICATIONS: ARMLESS SEATS

Model:	CAM SN1 FS17 Single-Seat	CAM SN2 FS17 2-Seater	CAM SN3 FS17 3-Seater
<b>Dimensions</b>			
Height	30"	30"	30"
Width	27.5"	54.5"	81.5"
Depth	28"	28"	28"
Seat Depth	20.25"	20.25"	20.25"
Seat Height	16.75"	16.75"	16.75"
Back Height	13.25"	13.25"	13.25"
<b>Materials</b>			
COM (Fully Upholstered)	3.25 yd	5.75 yd	8 yd
COM (Multi-Upholstery)			
Seat Only	1.75 yd	3.25 yd	5 yd
Back Only	1.6 yd	3 yd	4.75 yd
COL (Fully Upholstered)	63 sq ft	115 sq ft	130 sq ft
COL (Multi-Upholstery)			
Seat Only	31 sq ft	63 sq ft	80 sq ft
Back Only	31 sq ft	57 sq ft	75 sq ft
<b>Weight and Capacity</b>			
Weight	54 lb	95 lb	148 lb
Weight Capacity Warranty	400 lb	800 lb	800 lb

### SPECIFICATIONS: SEATS WITH SINGLE ARM

Model:	CAM SN1 FS10 CAM SN1 FS12 Single Seat	CAM SN2 FS10 CAM SN2 FS12 2-Seater	CAM SN3 FS10 CAM SN3 FS12 3-Seater
<b>Dimensions</b>			
Height	30"	30"	30"
Width	30"	57"	84"
Depth	28"	28"	28"
Seat Depth	20.25"	20.25"	20.25"
Seat Height	16.75"	16.75"	16.75"
Back Height	13.25"	13.25"	13.25"
<b>Materials</b>			
COM (Fully Upholstered)	4 yd	6.5 yd	9 yd
COM (Multi-Upholstery)			
Seat Only	1.75 yd	3.25 yd	5 yd
Back Only	1.6 yd	3 yd	4.75 yd
Arms Only	1.25 yd	1.25 yd	1.25 yd
COL (Fully Upholstered)	78 sq ft	126 sq ft	150 sq ft
COL (Multi-Upholstery)			
Seat Only	31 sq ft	63 sq ft	80 sq ft
Back Only	31 sq ft	57 sq ft	75 sq ft
Arms Only	26 sq ft	26 sq ft	26 sq ft
<b>Weight and Capacity</b>			
Weight	65 lb	105 lb	159 lb
Weight Capacity Warranty	400 lb	800 lb	800 lb

### SPECIFICATIONS: BENCHES

Model:	CAM SN1 FS2 Single Seat	CAM SN2 FS2 2-Seater	CAM SN3 FS2 3-Seater
<b>Dimensions</b>			
Height	16.75"	16.75"	16.75"
Width	27.5"	54.5"	81.5"
Depth	28"	28"	28"
Seat Depth	28"	28"	28"
Seat Height	16.75"	16.75"	16.75"
<b>Materials</b>			
COM (Fully Upholstered)	2 yd	3.75 lb	5 yd
COL (Fully Upholstered)	36 sq ft	68 sq ft	84 sq ft
<b>Weight and Capacity</b>			
Weight	35 lb	56 lb	78 lb
Weight Capacity Warranty	400 lb	800 lb	800 lb

# Cameo

## INLINE AND COFFEE TABLES

### *Design with distinction.*

Too many contemporary collections promise adaptable configurations but fall short. Cameo includes a wide variety of seats, benches and tables—for traditional and modular configurations that fit any space. Something truly mod-mod (at last).



*Inline Table (Seats not Included)*

**EFFECTIVE DECEMBER 1, 2021**

### Featured Models

**INLINE TABLE :: \$1,105**

Cameo inline table, laminate table top, chrome base finish

**CORNER TABLE :: \$1,140**

Cameo corner table, laminate table top, bronze base finish

**COFFEE TABLE :: \$2,128**

Cameo rectangular coffee table, laminate table top, charcoal base finish

## INLINE AND COFFEE TABLES

### 1. Product

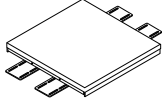
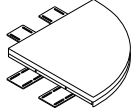
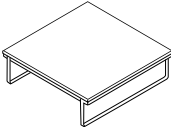
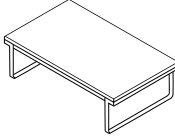
Model	Code	Price	
Inline Table	CAMT TTL1	\$855	
Corner Table	CAMT TTL4	\$1,140	
Square Coffee Table	CAMT TT8	\$2,128	
Rectangular Coffee Table	CAMT TT9	\$2,128	

The inline table (CAMT TTL1) and the corner table (CAMT TTL4) are shipped standard with a total of two sets of gangers (4 brackets) to be supported between two upholstered units.

### 2. Tabletop

Material	Code	Price	
Laminate	TM3	+ \$0	
Laminate Finish	Code	Price	
Field Elm	TL13	+ \$0	
Uptown Walnut	TL14	+ \$0	
Skyline Walnut	TL15	+ \$0	
Frosty White	TL16	+ \$0	
Classic Linen	TL17	+ \$0	

### 3. Table Base

Metal Finish	Code	Price	
Charcoal	BF04	+ \$0	
Bronze	BF05	+ \$0	
Chrome	BF06	+ \$250	

Finish also applies to the edge band.

### 4. Packaging

Packaging	Code	Price	
Partially Assembled in Carton	P3	+ \$0	

### SPECIFICATIONS: LINKING TABLES

Model:	Inline Table	Corner Table
Width	27"	39.5"
Depth	28"	28.3"
Height	14.5"	14.5"
Weight	47 lb	44 lb

### SPECIFICATIONS: COFFEE TABLES

Model:	Square Coffee Table	Rectangular Coffee Table
<b>Dimensions</b>		
Width	47.25"	47.3"
Depth	47.25"	27.8"
Height	14.5"	14.5"
Weight	120 lb	72 lb



Rectangular Coffee Table

# Composium

CURVE CLUB CHAIR, SETTEE AND SOFA

## *Perfect harmony.*

Transitional styling that blends well with collaboration areas and group housing defines Composium® Curve. This robust lounge seating collection offers three back styles, four valance styles and 11 foot styles to make it a comfortable seating choice for industrial, formal higher education or assisted living settings. Composium is rugged and easy to maintain with field-replaceable parts and durable steel-rail construction that withstands tough environments. Our PatternMatch® expertise ensures that every chair is a perfect match. Add an optional tablet arm or arm cap to create truly unique seating—just like you imagined.



*Club Chair With Wood Tapered Feet*

**EFFECTIVE DECEMBER 1, 2021**

## Featured Models

### **CLUB CHAIR WITH PLASTIC FEET :: \$1,943**

Composium Curve club chair, square back, arched valance, black plastic feet, fully upholstered, grade 1 textile

### **CLUB CHAIR WITH WOOD TAPERED FEET :: \$2,083**

Composium Curve club chair, square back, full valance, wood tapered square feet, fully upholstered, grade 1 textile

### **SETTEE WITH WOOD SIDE RAILS :: \$2,951**

Composium Curve settee, square back, integrated valance, wood tapered square feet with side rails, fully upholstered, grade 3 textile



### Features

- Club, settee and sofa sizes
- PatternMatch® expertise and multi-upholstery options
- Durable steel-rail construction
- Three back types — square, round and scalloped
- Four valance styles — full, integrated, three-quarter and arched
- 11 foot styles including casters, metal pole and wood
- Optional clean-out space
- Sustainable manufacturing and Take Back Program
- 300 lb weight capacity warranty per seat
- Optional power module available

### 1. Product

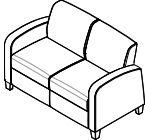
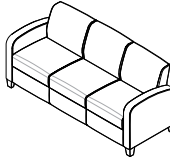
Model and Size	Code	Price	
Club	CP AS3 SN1	\$1,943	
Settee	CP AS3 SN2	\$2,518	
Sofa	CP AS3 SN3	\$3,072	

Order Compositum ottoman and bench seating on page 104.

### 2. Back

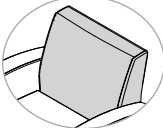
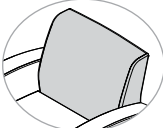
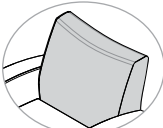
Back Shape	Code	Price	
Square	BS1	+\$0	
Round	BS2	+\$0	
Scalloped	BS3	+\$0	

### 3. Seat

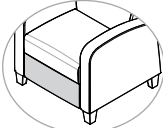
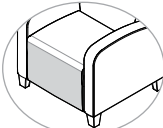
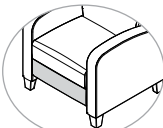
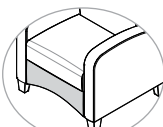
Valance Style	Code	Price	
Full	SV1	+\$0	
Integrated	SV2	+\$0	
Three-Quarter	SV3	+\$0	
Arched	SV4	+\$0	

### 3. Seat (Cont.)

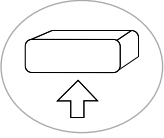
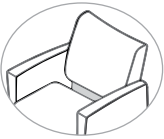
Seat Options	Code	Price	
<b>Removable Cushion</b>			
For Club Chair	SX1	+ \$59	
For Settee	SX1	+ \$118	
For Sofa	SX1	+ \$177	
<b>Clean-Out</b>			
For Club Chair	SX2	+ \$0	
For Settee	SX2	+ \$0	
For Sofa	SX2	+ \$0	



Removable cushion not available with clean-out or integrated valance.



Club Chair With Plastic Feet

## CURVE CLUB CHAIR, SETTEE AND SOFA

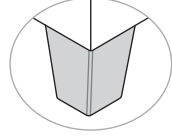
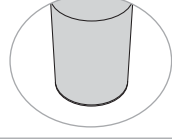
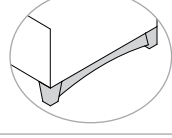
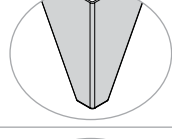
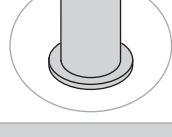
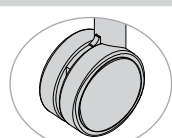
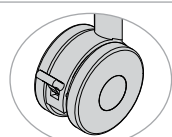
### 4. Foot

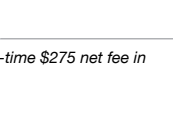
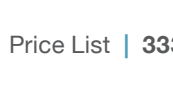
Foot Style and Color	Code	Price	
<b>Feet</b>			
Standard Plastic, Black	LS1	+ \$0	
Wood Tapered Square	LS12	+ \$140	
Wood Tapered Cylinder	LS11	+ \$140	
Wood Tapered Square With Side Rails	LS13	+ \$200	
Metal Angular, Brushed Aluminum	LS6	+ \$120	
Metal 1.5" Pole, Brushed Aluminum	LS7	+ \$120	
Metal 1.5" Pole, Silver Powder Coat	LS8	+ \$120	
<b>Casters</b>			
Non-Locking Caster, Black	LS2	+ \$100	
Non-Locking Caster, Silver	LS3	+ \$100	
Locking Caster, Black	LS4	+ \$120	
Locking Caster, Silver	LS5	+ \$120	

### 5. Frame (For Wooden Feet LS11/LS12/LS13)

Frame Finish Color	Code	Price	
Clear Maple	FCW1	+ \$0	
Medium Cherry	FCW2	+ \$0	
Amber Mahogany	FCW3	+ \$0	
Espresso	FCW4	+ \$0	
Stain-to-Match	STM	+ \$70	
New Custom Stain	STL	+ \$275	

New Custom Stain (STL): If stain is not in our library, add this one-time \$275 net fee in addition to the \$70 stain-to-match (STM) cost.

## 6. Power

Power Location	Code	Price
Right Hand, Front of Unit	PFR	+ \$250
Left Hand, Front of Unit	PFL	+ \$250
Both Hands, Front of Unit	PFB	+ \$500

Power Color	Code	Price
Silver	PC2	+ \$0
Black	PC1	+ \$0

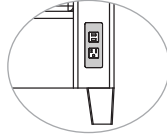
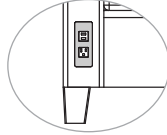

Power located on both hands (PFB) not available with club chair models (SN1).

## 7. Material

Protection	Code	Price
Fire Retardancy		Club    Settee    Sofa
CAL 133	UCAL	+ \$262    + \$377    + \$494

Cleaning	Code	Price
Moisture Barrier		Club    Settee    Sofa
Seat Only	UM2	+ \$59    + \$118    + \$177
Back Only	UM1	+ \$59    + \$118    + \$177
Seat and Back	UM3	+ \$118    + \$236    + \$354

Fully Upholstered	Code	Price
Seat, Back, Arm and Valance Textile		Club    Settee    Sofa
Fabric/Vinyl Grade 1	FG1/VG1	+ \$0    + \$0    + \$0
COM	COM	+ \$53    + \$78    + \$100
Fabric/Vinyl Grade 2	FG2/VG2	+ \$53    + \$78    + \$100
Fabric/Vinyl Grade 3	FG3/VG3	+ \$158    + \$233    + \$300
Fabric/Vinyl Grade 4	FG4/VG4	+ \$263    + \$388    + \$500
Fabric/Vinyl Grade 5	FG5/VG5	+ \$394    + \$582    + \$750
Fabric/Vinyl Grade 6	FG6/VG6	+ \$578    + \$853    + \$1,100
Fabric/Vinyl Grade 7	FG7/VG7	+ \$814    + \$1,202    + \$1,550
Leather Grade 1	LG1	+ \$834    + \$1,230    + \$1,592
COL	COL	+ \$1,095    + \$1,614    + \$2,089
Leather Grade 2	LG2	+ \$1,095    + \$1,614    + \$2,089
Leather Grade 3	LG3	+ \$1,512    + \$2,229    + \$2,885

## CURVE CLUB CHAIR, SETTEE AND SOFA

## 7. Material (Cont.)

Multi-Upholstery	Code	Price		
		Club	Settee	Sofa
Multi-Upholstery Upcharge	UMU	+ \$113	+ \$113	+ \$113

Seat Textile Only		Price		
		Club	Settee	Sofa
Fabric/Vinyl Grade 1	FG1/VG1	+ \$0	+ \$0	+ \$0
COM	COM	+ \$8	+ \$14	+ \$20
Fabric/Vinyl Grade 2	FG2/VG2	+ \$8	+ \$14	+ \$20
Fabric/Vinyl Grade 3	FG3/VG3	+ \$23	+ \$42	+ \$60
Fabric/Vinyl Grade 4	FG4/VG4	+ \$39	+ \$70	+ \$100
Fabric/Vinyl Grade 5	FG5/VG5	+ \$58	+ \$105	+ \$150
Fabric/Vinyl Grade 6	FG6/VG6	+ \$84	+ \$153	+ \$220
Fabric/Vinyl Grade 7	FG7/VG7	+ \$119	+ \$215	+ \$310
Leather Grade 1	LG1	+ \$122	+ \$221	+ \$319
COL	COL	+ \$159	+ \$289	+ \$418
Leather Grade 2	LG2	+ \$159	+ \$289	+ \$418
Leather Grade 3	LG3	+ \$220	+ \$399	+ \$577

Back Textile Only		Price		
		Club	Settee	Sofa
Fabric/Vinyl Grade 1	FG1/VG1	+ \$0	+ \$0	+ \$0
COM	COM	+ \$15	+ \$28	+ \$40
Fabric/Vinyl Grade 2	FG2/VG2	+ \$15	+ \$28	+ \$40
Fabric/Vinyl Grade 3	FG3/VG3	+ \$44	+ \$84	+ \$118
Fabric/Vinyl Grade 4	FG4/VG4	+ \$72	+ \$139	+ \$197
Fabric/Vinyl Grade 5	FG5/VG5	+ \$108	+ \$209	+ \$295
Fabric/Vinyl Grade 6	FG6/VG6	+ \$159	+ \$306	+ \$432
Fabric/Vinyl Grade 7	FG7/VG7	+ \$224	+ \$430	+ \$609
Leather Grade 1	LG1	+ \$229	+ \$441	+ \$625
COL	COL	+ \$301	+ \$578	+ \$820
Leather Grade 2	LG2	+ \$301	+ \$578	+ \$820
Leather Grade 3	LG3	+ \$415	+ \$798	+ \$1,132

Arms Textile Only		Price		
		Club	Settee	Sofa
Fabric/Vinyl Grade 1	FG1/VG1	+ \$0	+ \$0	+ \$0
COM	COM	+ \$23	+ \$23	+ \$21
Fabric/Vinyl Grade 2	FG2/VG2	+ \$23	+ \$23	+ \$21
Fabric/Vinyl Grade 3	FG3/VG3	+ \$69	+ \$67	+ \$63
Fabric/Vinyl Grade 4	FG4/VG4	+ \$115	+ \$111	+ \$104
Fabric/Vinyl Grade 5	FG5/VG5	+ \$172	+ \$166	+ \$156
Fabric/Vinyl Grade 6	FG6/VG6	+ \$252	+ \$243	+ \$229
Fabric/Vinyl Grade 7	FG7/VG7	+ \$355	+ \$342	+ \$322
Leather Grade 1	LG1	+ \$364	+ \$350	+ \$331
COL	COL	+ \$477	+ \$459	+ \$434
Leather Grade 2	LG2	+ \$477	+ \$459	+ \$434
Leather Grade 3	LG3	+ \$659	+ \$634	+ \$600

### 7. Material (Cont.)

Multi-Upholstery (Cont.)	Code	Price		
		Club	Settee	Sofa
Valance Textile Only				
Fabric/Vinyl Grade 1	FG1/VG1	+ \$0	+ \$0	+ \$0
COM	COM	+ \$8	+ \$14	+ \$20
Fabric/Vinyl Grade 2	FG2/VG2	+ \$8	+ \$14	+ \$20
Fabric/Vinyl Grade 3	FG3/VG3	+ \$23	+ \$42	+ \$60
Fabric/Vinyl Grade 4	FG4/VG4	+ \$39	+ \$70	+ \$100
Fabric/Vinyl Grade 5	FG5/VG5	+ \$58	+ \$105	+ \$150
Fabric/Vinyl Grade 6	FG6/VG6	+ \$84	+ \$153	+ \$220
Fabric/Vinyl Grade 7	FG7/VG7	+ \$119	+ \$215	+ \$310
Leather Grade 1	LG1	+ \$122	+ \$221	+ \$319
COL	COL	+ \$159	+ \$289	+ \$418
Leather Grade 2	LG2	+ \$159	+ \$289	+ \$418
Leather Grade 3	LG3	+ \$220	+ \$399	+ \$577

If different fabrics are selected for the seat, back, arms and/or valance add the multiple upholstery upcharge (UMU) as well, even if the two fabrics are the same grade.

Please reference the Textile Reference Guide for pricing on fabric over grade 7 and leather over grade 3. Additional CAL 133 information can be found on page 10.

### 8. Packaging

Packaging	Code	Price
Fully Assembled in a Carton	P1	+ \$0

### SPECIFICATIONS

Model:	Club CP AS3 SN1	Settee CP AS3 SN2	Sofa CP AS3 SN3
<b>Dimensions</b>			
Height	34"	34"	34"
Width	31"	53"	75"
Depth	28"	28"	28"
Seat Width	22"	44"	66"
Seat Depth	19.5"	19.5"	19.5"
Seat Height	19.5"	19.5"	19.5"
Back Height	16"	16"	16"
Arm Height	26"	26"	26"
<b>Materials</b>			
COM (Fully Upholstered)	5.3 yd	7.9 yd	10.5 yd
COM (Multi-Upholstery)			
Seat Only	1.9 yd	3.2 yd	3.8 yd
Back Only	2.2 yd	4.1 yd	5.8 yd
Arms Only	3.8 yd	3.8 yd	3.8 yd
Valance Only	1 yd	1.3 yd	1.3 yd
COL (Fully Upholstered)	83.3 sq ft	122.5 sq ft	163.7 sq ft
COL (Multi-Upholstery)			
Seat Only	29.4 sq ft	49 sq ft	58.8 sq ft
Back Only	33.4 sq ft	63.7 sq ft	90.2 sq ft
Arms Only	58.8 sq ft	58.8 sq ft	58.8 sq ft
Valance Only	14.7 sq ft	19.6 sq ft	19.6 sq ft
<b>Weight and Capacity</b>			
Weight	70 lb	115 lb	160 lb
Weight Capacity Warranty (Per Seat)	300 lb	300 lb	300 lb

Yardage requirements for COM and COL are for solid and non-directional fabrics. Additional material may be required for larger repeating patterns.



Settee With Wood Side Rails

# Composium

FLAIR CLUB CHAIR, SETTEE AND SOFA

## *Perfect harmony.*

Composium® Flair delivers contemporary elegance via the retro flair arm style. This robust lounge seating collection offers three back styles, four valance styles and 11 foot styles to make it a comfortable seating choice, from corporate to hospitality to higher education applications. Composium is rugged and easy to maintain with field-replaceable parts and durable steel-rail construction that withstands tough environments. Our PatternMatch® expertise ensures that every chair is a perfect match. Add an optional tablet arm or arm cap to create truly unique seating—just like you imagined.



*Club Chair With Metal Pole Feet*

**EFFECTIVE DECEMBER 1, 2021**

## Featured Models

### **CLUB CHAIR WITH METAL POLE FEET :: \$2,111**

Composium Flair club chair, scalloped back, full valance, brushed aluminum metal pole feet, fully upholstered, grade 2 vinyl

### **SETTEE WITH METAL POLE FEET :: \$2,638**

Composium Flair settee, square back, three-quarter valance, brushed aluminum metal pole feet, fully upholstered, grade 1 textile



### **SOFA WITH WOOD FEET AND ARM CAPS :: \$3,834**

Composium Flair sofa, square back, arched valance, wood arm caps, wood tapered square feet, fully upholstered, grade 4 textile

## Features

- Club, settee and sofa sizes
- PatternMatch™ expertise and multi-upholstery options
- Durable steel-rail construction
- Three back types — square, round and scalloped
- Four valance styles — full, integrated, three-quarter and arched
- 11 foot styles including casters, metal pole and wood
- Optional clean-out space
- Optional wood arm cap and cushion
- Sustainable manufacturing and Take Back Program
- 300 lb weight capacity warranty per seat
- Optional power module available

### 1. Product

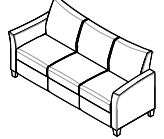
Model and Size	Code	Price	
Club	CP AS2 SN1	\$1,943	
Settee	CP AS2 SN2	\$2,518	
Sofa	CP AS2 SN3	\$3,072	

### 2. Arms

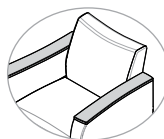
Arm Cap	Code	Price	
Wood Arm Cap	ACP1	+ \$147	

## FLAIR CLUB CHAIR, SETTEE AND SOFA

### 3. Back

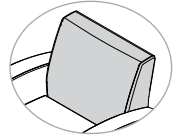
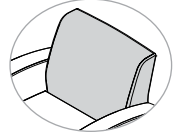
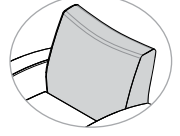
Back Shape	Code	Price	
Square	BS1	+ \$0	
Round	BS2	+ \$0	
Scalloped	BS3	+ \$0	

### 4. Seat

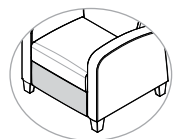
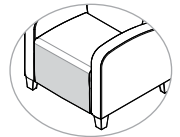
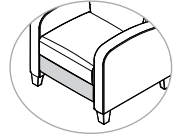
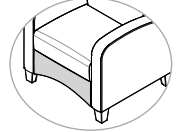
Valance Style	Code	Price	
Full	SV1	+ \$0	
Integrated	SV2	+ \$0	
Three-Quarter	SV3	+ \$0	
Arched	SV4	+ \$0	

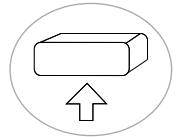
Removable Cushion	Code	Price	
For Club Chair	SX1	+ \$59	
For Settee	SX1	+ \$118	
For Sofa	SX1	+ \$177	

## 4. Seat (Cont.)

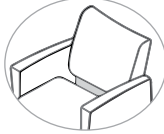
Clean-Out	Code	Price	
For Club Chair	SX2	+ \$0	
For Settee	SX2	+ \$0	
For Sofa	SX2	+ \$0	

Removable cushion not available with clean-out or integrated valance.

## 5. Foot

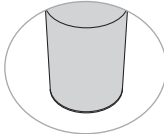
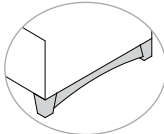
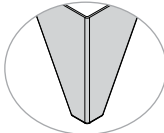
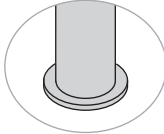
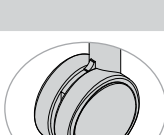
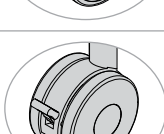
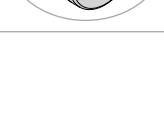
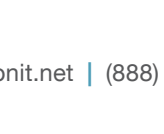
Foot Style and Color	Code	Price	
<b>Feet</b>			
Standard Plastic, Black	LS1	+ \$0	
Wood Tapered Square	LS12	+ \$140	
Wood Tapered Cylinder	LS11	+ \$140	
Wood Tapered Square With Side Rails	LS13	+ \$200	
Metal Angular, Brushed Aluminum	LS6	+ \$120	
Metal 1.5" Pole, Brushed Aluminum	LS7	+ \$120	
Metal 1.5" Pole, Silver Powder Coat	LS8	+ \$120	
<b>Casters</b>			
Non-Locking Caster, Black	LS2	+ \$100	
Non-Locking Caster, Silver	LS3	+ \$100	
Locking Caster, Black	LS4	+ \$120	
Locking Caster, Silver	LS5	+ \$120	

## FLAIR CLUB CHAIR, SETTEE AND SOFA

## 6. Frame (For Wooden Feet LS11/LS12/LS13 or Tablet Arm AX1/AX4)

Frame Finish Color	Code	Price	
Clear Maple	FCW1	+ \$0	
Medium Cherry	FCW2	+ \$0	
Amber Mahogany	FCW3	+ \$0	
Espresso	FCW4	+ \$0	
Stain-to-Match	STM	+ \$70	
New Custom Stain	STL	+ \$275	

New Custom Stain (STL): If stain is not in our library, add this one-time \$275 net fee in addition to the \$70 stain-to-match (STM) cost.

## 7. Power

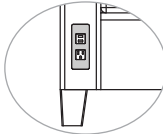
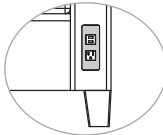
Power Location	Code	Price	
Right Hand, Front of Unit	PFR	+ \$250	
Left Hand, Front of Unit	PFL	+ \$250	
Both Hands, Front of Unit	PFB	+ \$500	
Power Color	Code	Price	
Silver	PC2	+ \$0	
Black	PC1	+ \$0	

Power located on both hands (PFB) not available with club chair models (SN1).

## 8. Material

Protection	Code	Price		
<b>Fire Retardancy</b>		Club	Settee	Sofa
CAL 133	UCAL	+ \$262	+ \$377	+ \$494
Cleaning	Code	Price		
<b>Moisture Barrier</b>		Club	Settee	Sofa
Seat Only	UM2	+ \$59	+ \$118	+ \$177
Back Only	UM1	+ \$59	+ \$118	+ \$177
Seat and Back	UM3	+ \$118	+ \$236	+ \$354

### 8. Material (Cont.)

Fully Upholstered	Code	Price		
Seat, Back, Arm and Valance Textile		Club	Settee	Sofa
Fabric/Vinyl Grade 1	FG1/VG1	+ \$0	+ \$0	+ \$0
COM	COM	+ \$48	+ \$73	+ \$95
Fabric/Vinyl Grade 2	FG2/VG2	+ \$48	+ \$73	+ \$95
Fabric/Vinyl Grade 3	FG3/VG3	+ \$143	+ \$218	+ \$285
Fabric/Vinyl Grade 4	FG4/VG4	+ \$238	+ \$363	+ \$475
Fabric/Vinyl Grade 5	FG5/VG5	+ \$357	+ \$544	+ \$713
Fabric/Vinyl Grade 6	FG6/VG6	+ \$523	+ \$798	+ \$1,045
Fabric/Vinyl Grade 7	FG7/VG7	+ \$737	+ \$1,124	+ \$1,473
Leather Grade 1	LG1	+ \$758	+ \$1,154	+ \$1,516
COL	COL	+ \$995	+ \$1,515	+ \$1,990
Leather Grade 2	LG2	+ \$995	+ \$1,515	+ \$1,990
Leather Grade 3	LG3	+ \$1,374	+ \$2,092	+ \$2,748
Multi-Upholstery	Code	Price		
		Club	Settee	Sofa
Multi-Upholstery Upcharge	UMU	+ \$113	+ \$113	+ \$113
Seat Textile Only		Club	Settee	Sofa
Fabric/Vinyl Grade 1	FG1/VG1	+ \$0	+ \$0	+ \$0
COM	COM	+ \$7	+ \$13	+ \$19
Fabric/Vinyl Grade 2	FG2/VG2	+ \$7	+ \$13	+ \$19
Fabric/Vinyl Grade 3	FG3/VG3	+ \$21	+ \$39	+ \$57
Fabric/Vinyl Grade 4	FG4/VG4	+ \$35	+ \$65	+ \$95
Fabric/Vinyl Grade 5	FG5/VG5	+ \$52	+ \$98	+ \$143
Fabric/Vinyl Grade 6	FG6/VG6	+ \$76	+ \$143	+ \$209
Fabric/Vinyl Grade 7	FG7/VG7	+ \$107	+ \$202	+ \$295
Leather Grade 1	LG1	+ \$111	+ \$207	+ \$304
COL	COL	+ \$145	+ \$271	+ \$398
Leather Grade 2	LG2	+ \$145	+ \$271	+ \$398
Leather Grade 3	LG3	+ \$200	+ \$375	+ \$550
Back Textile Only		Club	Settee	Sofa
Fabric/Vinyl Grade 1	FG1/VG1	+ \$0	+ \$0	+ \$0
COM	COM	+ \$14	+ \$26	+ \$38
Fabric/Vinyl Grade 2	FG2/VG2	+ \$14	+ \$26	+ \$38
Fabric/Vinyl Grade 3	FG3/VG3	+ \$40	+ \$78	+ \$112
Fabric/Vinyl Grade 4	FG4/VG4	+ \$66	+ \$130	+ \$187
Fabric/Vinyl Grade 5	FG5/VG5	+ \$98	+ \$195	+ \$280
Fabric/Vinyl Grade 6	FG6/VG6	+ \$144	+ \$286	+ \$410
Fabric/Vinyl Grade 7	FG7/VG7	+ \$202	+ \$403	+ \$578
Leather Grade 1	LG1	+ \$208	+ \$413	+ \$595
COL	COL	+ \$273	+ \$542	+ \$781
Leather Grade 2	LG2	+ \$273	+ \$542	+ \$781
Leather Grade 3	LG3	+ \$377	+ \$749	+ \$1,078

### 8. Material (Cont.)

Multi-Upholstery	Code	Price		
Arms Textile Only		Club	Settee	Sofa
Fabric/Vinyl Grade 1	FG1/VG1	+ \$0	+ \$0	+ \$0
COM	COM	+ \$21	+ \$21	+ \$20
Fabric/Vinyl Grade 2	FG2/VG2	+ \$21	+ \$21	+ \$20
Fabric/Vinyl Grade 3	FG3/VG3	+ \$63	+ \$62	+ \$60
Fabric/Vinyl Grade 4	FG4/VG4	+ \$104	+ \$104	+ \$99
Fabric/Vinyl Grade 5	FG5/VG5	+ \$156	+ \$155	+ \$148
Fabric/Vinyl Grade 6	FG6/VG6	+ \$228	+ \$227	+ \$218
Fabric/Vinyl Grade 7	FG7/VG7	+ \$321	+ \$320	+ \$306
Leather Grade 1	LG1	+ \$331	+ \$328	+ \$315
COL	COL	+ \$434	+ \$431	+ \$414
Leather Grade 2	LG2	+ \$434	+ \$431	+ \$414
Leather Grade 3	LG3	+ \$599	+ \$595	+ \$571
Valance Textile Only		Club	Settee	Sofa
Fabric/Vinyl Grade 1	FG1/VG1	+ \$0	+ \$0	+ \$0
COM	COM	+ \$7	+ \$13	+ \$19
Fabric/Vinyl Grade 2	FG2/VG2	+ \$7	+ \$13	+ \$19
Fabric/Vinyl Grade 3	FG3/VG3	+ \$21	+ \$39	+ \$57
Fabric/Vinyl Grade 4	FG4/VG4	+ \$35	+ \$65	+ \$95
Fabric/Vinyl Grade 5	FG5/VG5	+ \$52	+ \$98	+ \$143
Fabric/Vinyl Grade 6	FG6/VG6	+ \$76	+ \$143	+ \$209
Fabric/Vinyl Grade 7	FG7/VG7	+ \$107	+ \$202	+ \$295
Leather Grade 1	LG1	+ \$111	+ \$207	+ \$304
COL	COL	+ \$145	+ \$271	+ \$398
Leather Grade 2	LG2	+ \$145	+ \$271	+ \$398
Leather Grade 3	LG3	+ \$200	+ \$375	+ \$550

If different fabrics are selected for the seat, back, arms and/or valance add the multiple upholstery upcharge (UMU) as well, even if the two fabrics are the same grade.

Please reference the Textile Reference Guide for pricing on fabric over grade 7 and leather over grade 3. Additional CAL 133 information can be found on page 10.

### 9. Packaging

Packaging	Code	Price
Fully Assembled in a Carton	P1	+ \$0



EFFECTIVE DECEMBER 1, 2021 | GSA SIN #: 33721

### SPECIFICATIONS

Model:	Club CP AS2 SN1	Settee CP AS2 SN2	Sofa CP AS2 SN3
<b>Dimensions</b>			
Height	34"	34"	34"
Width	33"	55"	77"
Depth	28"	28"	28"
Seat Width	22"	44"	66"
Seat Depth	19.5"	19.5"	19.5"
Seat Height	19.5"	19.5"	19.5"
Back Height	16"	16"	16"
Arm Height	26"	26"	26"
<b>Materials</b>			
COM (Fully Upholstered)	5.3 yd	7.9 yd	10.5 yd
COM (Multi-Upholstery)			
Seat Only	1.9 yd	3.2 yd	3.8 yd
Back Only	2.2 yd	4.1 yd	5.8 yd
Arms Only	3.8 yd	3.8 yd	3.8 yd
Valance Only	1 yd	1.3 yd	1.3 yd
COL (Fully Upholstered)	83.3 sq ft	122.5 sq ft	163.7 sq ft
COL (Multi-Upholstery)			
Seat Only	29.4 sq ft	49 sq ft	58.8 sq ft
Back Only	33.4 sq ft	63.7 sq ft	90.2 sq ft
Arms Only	58.8 sq ft	58.8 sq ft	58.8 sq ft
Valance Only	14.7 sq ft	19.6 sq ft	19.6 sq ft
<b>Weight and Capacity</b>			
Weight	70 lb	115 lb	160 lb
Weight Capacity	300 lb	300 lb	300 lb
Warranty (Per Seat)			

*Yardage requirements for COM and COL are for solid and non-directional fabrics. Additional material may be required for larger repeating patterns.*



*Sofa With Wood Feet and Arm Caps*

# Composium

SHARP CLUB CHAIR, SETTEE AND SOFA

## *Perfect harmony.*

Composium® Sharp delivers harmonious contemporary style with straight lines and minimalist styling. This robust lounge seating collection offers three back styles, four valance styles and 11 foot styles to make it a comfortable seating choice for industrial, formal or higher education settings. Composium is rugged and easy to maintain with field-replaceable parts and durable steel-rail construction that withstands tough environments. Our PatternMatch® expertise ensures that every chair is a perfect match. Add an optional tablet arm or arm cap to create truly unique seating—just like you imagined.



*Club Chair With Plastic Feet*

**EFFECTIVE DECEMBER 1, 2021**

## Featured Models

### **CLUB CHAIR WITH PLASTIC FEET :: \$1,973**

Composium Sharp club chair, square back, full valance, plastic feet, fully upholstered, grade 3 textile

### **SETTEE WITH METAL POLE FEET :: \$3,681**

Composium Sharp settee, square back, three-quarter valance, brushed aluminum metal pole feet, fully upholstered, grade 7 textile



### **SOFA WITH WOOD SIDE RAILS :: \$4,664**

Composium Sharp sofa, round back, arched valance, wood tapered square legs with side rails, fully upholstered, grade 7 textile

### Features

- Club, settee and sofa sizes
- PatternMatch expertise and multi-upholstery options
- Durable steel-rail construction
- Three back types — square, round and scalloped
- Four valance styles — full, integrated, three-quarter and arched
- 11 foot styles including casters, metal pole and wood
- Optional clean-out space
- Optional tablet arm and wood arm cap
- Sustainable manufacturing and Take Back Program
- 300 lb weight capacity warranty per seat
- Optional power module available

### 1. Product

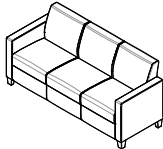
Model and Size	Code	Price	
Club	CP AS1 SN1	\$1,823	
Settee	CP AS1 SN2	\$2,398	
Sofa	CP AS1 SN3	\$2,952	

### 2. Arms

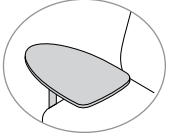
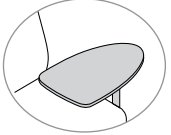
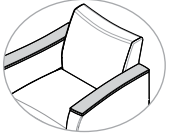
Tablet Arm	Code	Price	
Tablet Arm, Right	AX1	+ \$342	
Table Arm, Left	AX4	+ \$342	
Arm Cap	Code	Price	
Wood Arm Cap	ACP1	+ \$147	
Polyurethane Arm Cap	ACP2	+ \$147	

*Polyurethane arm (ACP2) is not available with tablet arm.*

### 3. Back

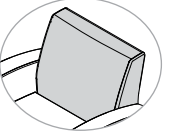
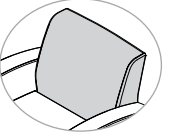
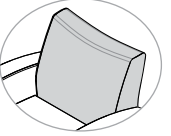
Back Shape	Code	Price	
Square	BS1	+ \$0	
Round	BS2	+ \$0	
Scalloped	BS3	+ \$0	

# COMPOSIUM SHARP

EFFECTIVE DECEMBER 1, 2021 | GSA SIN #: 33721

## 4. Seat

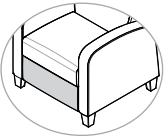
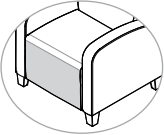
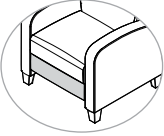
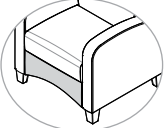
Valance Style	Code	Price	
Full	SV1	+\$0	
Integrated	SV2	+\$0	
Three-Quarter	SV3	+\$0	
Arched	SV4	+\$0	

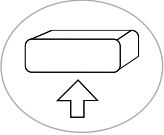

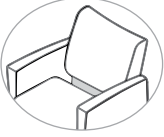
Removable Cushion	Code	Price	
For Club Chair	SX1	+\$59	
For Settee	SX1	+\$118	
For Sofa	SX1	+\$177	

Clean-Out	Code	Price	
For Club Chair	SX2	+\$0	
For Settee	SX2	+\$0	
For Sofa	SX2	+\$0	

Removable cushion not available with clean-out or integrated valance.

## SHARP CLUB CHAIR, SETTEE AND SOFA

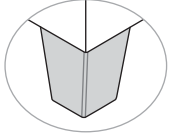
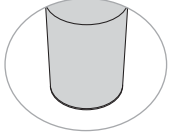
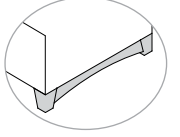
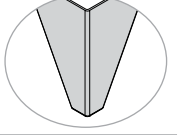
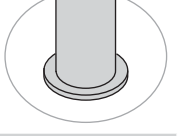
## 5. Foot

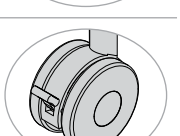
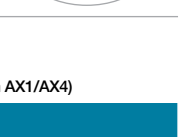
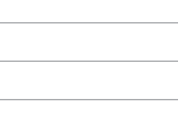
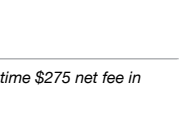
Foot Style and Color	Code	Price	
<b>Feet</b>			
Standard Plastic, Black	LS1	+\$0	
Wood Tapered Square	LS12	+\$140	
Wood Tapered Cylinder	LS11	+\$140	
Wood Tapered Square With Side Rails	LS13	+\$200	
Metal Angular, Brushed Aluminum	LS6	+\$120	
Metal 1.5" Pole, Brushed Aluminum	LS7	+\$120	
Metal 1.5" Pole, Silver Powder Coat	LS8	+\$120	
<b>Castors</b>			
Non-Locking Caster, Black	LS2	+\$100	
Non-Locking Caster, Silver	LS3	+\$100	
Locking Caster, Black	LS4	+\$120	
Locking Caster, Silver	LS5	+\$120	

## 6. Frame (For Wooden Feet LS11/LS12/LS13 or Tablet Arm AX1/AX4)

Frame Finish Color	Code	Price	
Clear Maple	FCW1	+\$0	
Medium Cherry	FCW2	+\$0	
Amber Mahogany	FCW3	+\$0	
Espresso	FCW4	+\$0	
Stain-to-Match	STM	+\$70	
New Custom Stain	STL	+\$275	

New Custom Stain (STL): If stain is not in our library, add this one-time \$275 net fee in addition to the \$70 stain-to-match (STM) cost.

### 7. Power

Power Location	Code	Price
Right Hand, Front of Unit	PFR	+ \$250
Left Hand, Front of Unit	PFL	+ \$250
Both Hands, Front of Unit	PFB	+ \$500

Power Color	Code	Price
Silver	PC2	+ \$0
Black	PC1	+ \$0

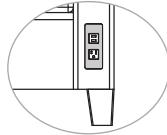
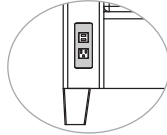

Power located on both hands (PFB) not available with club chair models (SN1).

### 8. Material

Protection	Code	Price
Fire Retardancy		Club    Settee    Sofa
CAL 133	UCAL	+ \$262    + \$377    + \$494

Cleaning	Code	Price
Moisture Barrier		Club    Settee    Sofa
Seat Only	UM2	+ \$59    + \$118    + \$177
Back Only	UM1	+ \$59    + \$118    + \$177
Seat and Back	UM3	+ \$118    + \$236    + \$354

Fully Upholstered	Code	Price
Seat, Back, Arm and Valance Textile		Club    Settee    Sofa
Fabric/Vinyl Grade 1	FG1/VG1	+ \$0    + \$0    + \$0
COM	COM	+ \$50    + \$75    + \$98
Fabric/Vinyl Grade 2	FG2/VG2	+ \$50    + \$75    + \$98
Fabric/Vinyl Grade 3	FG3/VG3	+ \$150    + \$225    + \$293
Fabric/Vinyl Grade 4	FG4/VG4	+ \$250    + \$375    + \$488
Fabric/Vinyl Grade 5	FG5/VG5	+ \$375    + \$563    + \$732
Fabric/Vinyl Grade 6	FG6/VG6	+ \$550    + \$825    + \$1,073
Fabric/Vinyl Grade 7	FG7/VG7	+ \$775    + \$1,163    + \$1,512
Leather Grade 1	LG1	+ \$800    + \$1,196    + \$1,550
COL	COL	+ \$1,050    + \$1,570    + \$2,034
Leather Grade 2	LG2	+ \$1,050    + \$1,570    + \$2,034
Leather Grade 3	LG3	+ \$1,450    + \$2,168    + \$2,809

### 8. Material (Cont.)

Multi-Upholstery	Code	Price		
		Club	Settee	Sofa
Multi-Upholstery Upcharge	UMU	+ \$113	+ \$113	+ \$113

Seat Textile Only		Price		
		Club	Settee	Sofa
Fabric/Vinyl Grade 1	FG1/VG1	+ \$0	+ \$0	+ \$0
COM	COM	+ \$8	+ \$14	+ \$20
Fabric/Vinyl Grade 2	FG2/VG2	+ \$8	+ \$14	+ \$20
Fabric/Vinyl Grade 3	FG3/VG3	+ \$22	+ \$41	+ \$59
Fabric/Vinyl Grade 4	FG4/VG4	+ \$37	+ \$68	+ \$98
Fabric/Vinyl Grade 5	FG5/VG5	+ \$55	+ \$101	+ \$147
Fabric/Vinyl Grade 6	FG6/VG6	+ \$80	+ \$148	+ \$215
Fabric/Vinyl Grade 7	FG7/VG7	+ \$113	+ \$209	+ \$303
Leather Grade 1	LG1	+ \$117	+ \$214	+ \$310
COL	COL	+ \$153	+ \$281	+ \$407
Leather Grade 2	LG2	+ \$153	+ \$281	+ \$407
Leather Grade 3	LG3	+ \$211	+ \$388	+ \$562

Back Textile Only		Price		
		Club	Settee	Sofa
Fabric/Vinyl Grade 1	FG1/VG1	+ \$0	+ \$0	+ \$0
COM	COM	+ \$14	+ \$27	+ \$39
Fabric/Vinyl Grade 2	FG2/VG2	+ \$14	+ \$27	+ \$39
Fabric/Vinyl Grade 3	FG3/VG3	+ \$42	+ \$81	+ \$115
Fabric/Vinyl Grade 4	FG4/VG4	+ \$69	+ \$135	+ \$192
Fabric/Vinyl Grade 5	FG5/VG5	+ \$103	+ \$202	+ \$287
Fabric/Vinyl Grade 6	FG6/VG6	+ \$151	+ \$296	+ \$421
Fabric/Vinyl Grade 7	FG7/VG7	+ \$213	+ \$417	+ \$593
Leather Grade 1	LG1	+ \$220	+ \$428	+ \$608
COL	COL	+ \$288	+ \$562	+ \$798
Leather Grade 2	LG2	+ \$288	+ \$562	+ \$798
Leather Grade 3	LG3	+ \$398	+ \$776	+ \$1,102

Arms Textile Only		Price		
		Club	Settee	Sofa
Fabric/Vinyl Grade 1	FG1/VG1	+ \$0	+ \$0	+ \$0
COM	COM	+ \$22	+ \$22	+ \$21
Fabric/Vinyl Grade 2	FG2/VG2	+ \$22	+ \$22	+ \$21
Fabric/Vinyl Grade 3	FG3/VG3	+ \$66	+ \$64	+ \$61
Fabric/Vinyl Grade 4	FG4/VG4	+ \$109	+ \$107	+ \$102
Fabric/Vinyl Grade 5	FG5/VG5	+ \$164	+ \$160	+ \$152
Fabric/Vinyl Grade 6	FG6/VG6	+ \$240	+ \$235	+ \$223
Fabric/Vinyl Grade 7	FG7/VG7	+ \$338	+ \$331	+ \$314
Leather Grade 1	LG1	+ \$349	+ \$340	+ \$322
COL	COL	+ \$458	+ \$447	+ \$423
Leather Grade 2	LG2	+ \$458	+ \$447	+ \$423
Leather Grade 3	LG3	+ \$632	+ \$616	+ \$584

### 8. Material (Cont.)

Multi-Upholstery (Cont.)	Code	Price		
		Club	Settee	Sofa
Valance Textile Only				
Fabric/Vinyl Grade 1	FG1/VG1	+ \$0	+ \$0	+ \$0
COM	COM	+ \$8	+ \$14	+ \$20
Fabric/Vinyl Grade 2	FG2/VG2	+ \$8	+ \$14	+ \$20
Fabric/Vinyl Grade 3	FG3/VG3	+ \$22	+ \$41	+ \$59
Fabric/Vinyl Grade 4	FG4/VG4	+ \$37	+ \$68	+ \$98
Fabric/Vinyl Grade 5	FG5/VG5	+ \$55	+ \$101	+ \$147
Fabric/Vinyl Grade 6	FG6/VG6	+ \$80	+ \$148	+ \$215
Fabric/Vinyl Grade 7	FG7/VG7	+ \$113	+ \$209	+ \$303
Leather Grade 1	LG1	+ \$117	+ \$214	+ \$310
COL	COL	+ \$153	+ \$281	+ \$407
Leather Grade 2	LG2	+ \$153	+ \$281	+ \$407
Leather Grade 3	LG3	+ \$211	+ \$388	+ \$562

If different fabrics are selected for the seat, back, arms and/or valance add the multiple upholstery upcharge (IMU) as well, even if the two fabrics are the same grade.

Please reference the Textile Reference Guide for pricing on fabric over grade 7 and leather over grade 3. Additional CAL 133 information can be found on page 10.

### 9. Packaging

Packaging	Code	Price
Fully Assembled in a Carton	P1	+ \$0

### SPECIFICATIONS

Model:	Club CP AS1 SN1	Settee CP AS1 SN2	Sofa CP AS1 SN3
<b>Dimensions</b>			
Height	34"	34"	34"
Width	31"	53"	75"
Depth	28"	28"	28"
Seat Width	22"	44"	66"
Seat Depth	19.5"	19.5"	19.5"
Seat Height	19.5"	19.5"	19.5"
Back Height	16"	16"	16"
Arm Height	26"	26"	26"
<b>Materials</b>			
COM (Fully Upholstered)	5.3 yd	7.9 yd	10.5 yd
COM (Multi-Upholstery)			
Seat Only	1.9 yd	3.2 yd	3.8 yd
Back Only	2.2 yd	4.1 yd	5.8 yd
Arms Only	3.8 yd	3.8 yd	3.8 yd
Valance Only	1 yd	1.3 yd	1.3 yd
COL (Fully Upholstered)	83.3 sq ft	122.5 sq ft	163.7 sq ft
COL (Multi-Upholstery)			
Seat Only	29.4 sq ft	49 sq ft	58.8 sq ft
Back Only	33.4 sq ft	63.7 sq ft	90.2 sq ft
Arms Only	58.8 sq ft	58.8 sq ft	58.8 sq ft
Valance Only	14.7 sq ft	19.6 sq ft	19.6 sq ft
<b>Weight and Capacity</b>			
Weight	70 lb	115 lb	160 lb
Weight Capacity Warranty (Per Seat)	300 lb	300 lb	300 lb

Yardage requirements for COM and COL are for solid and non-directional fabrics. Additional material may be required for larger repeating patterns.



Settee with Metal Pole Feet

# Composium

## OTTOMAN AND BENCHES

### *Perfect harmony.*

This robust bench and ottoman collection complement all Composium® lounge seating models. Three bench sizes—plus an ottoman—provide strategic accents for a functional and modular seating solution. An optional removable cushion and 10 foot styles make this line a comfortable and stylish soft seating choice. Composium is rugged and easy to maintain with field-replaceable parts and durable steel-rail construction in benches that withstands tough environments. Our PatternMatch® expertise ensures that every chair is a perfect match.



*1-Seat Bench With Wood Feet*

**EFFECTIVE DECEMBER 1, 2021**

### Featured Models

#### **OTTOMAN WITH CASTERS :: \$1,076**

Composium ottoman, non-locking casters, fully upholstered, grade 3 textile

#### **1-SEAT BENCH WITH WOOD FEET :: \$1,377**

Composium single-seat bench, wood tapered square feet, fully upholstered, grade 3 textile



#### **2-SEAT BENCH WITH METAL POLE FEET :: \$1,672**

Composium double-seat bench, brushed aluminum metal pole feet, fully upholstered, grade 3 vinyl

## Features

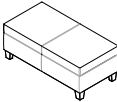
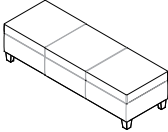

- Three bench sizes and an ottoman
- PatternMatch expertise and multi-upholstery options
- Durable steel-rail construction
- 11 foot styles including casters, metal pole and wood
- Sustainable manufacturing and Take Back Program
- 300 lb weight capacity warranty per seat
- Optional power module available

### 1. Product

Model	Code	Price	
Ottoman	CP FS1	\$908	
1-Seat Bench	CP FS2 SN1	\$1,162	
2-Seat Bench	CP FS2 SN2	\$1,462	
3-Seat Bench	CP FS2 SN3	\$1,762	

## OTTOMAN AND BENCHES

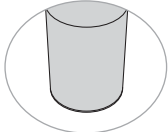
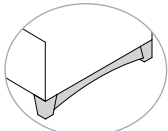
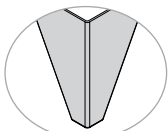
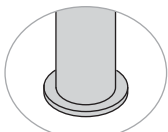
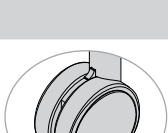
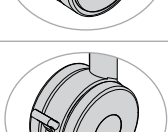
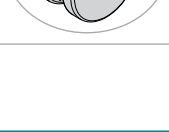
### 2. Foot

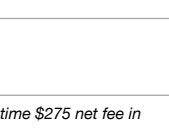
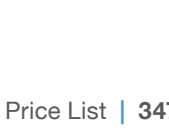
Foot Style and Color	Code	Price	
<b>Feet</b>			
Standard Plastic, Black	LS1	+ \$0	
Wood Tapered Square	LS12	+ \$140	
Wood Tapered Cylinder	LS11	+ \$140	
Wood Tapered Square With Side Rails	LS13	+ \$200	
Metal Angular, Brushed Aluminum	LS6	+ \$120	
Metal 1.5" Pole, Brushed Aluminum	LS7	+ \$120	
Metal 1.5" Pole, Silver Powder Coat	LS8	+ \$120	
<b>Casters</b>			
Non-Locking Caster, Black	LS2	+ \$100	
Non-Locking Caster, Silver	LS3	+ \$100	
Locking Caster, Black	LS4	+ \$120	
Locking Caster, Silver	LS5	+ \$120	

### 3. Frame (For Wooden Feet LS11/LS12/LS13)

Frame Finish Color	Code	Price
Clear Maple	FCW1	+ \$0
Medium Cherry	FCW2	+ \$0
Amber Mahogany	FCW3	+ \$0
Espresso	FCW4	+ \$0
Stain-to-Match	STM	+ \$70
New Custom Stain	STL	+ \$275

*New Custom Stain (STL): If stain is not in our library, add this one-time \$275 net fee in addition to the \$70 stain-to-match (STM) cost.*



## OTTOMAN AND BENCHES

### 4. Power

Power Location	Code	Price
Right Hand, Front of Unit	PFR	+ \$250
Left Hand, Front of Unit	PFL	+ \$250
Both Hands, Front of Unit	PFB	+ \$500

Power Color	Code	Price
Silver	PC2	+ \$0
Black	PC1	+ \$0

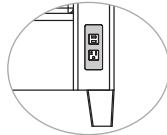
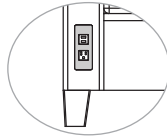

Ottoman with Casters

Power located on both hands (PFB) not available with ottoman (SN1) or single-seat bench models (SN1)

### 5. Material

Protection	Code	Price			
Fire Retardancy		Ottoman	1-Seat Bench	2-Seat Bench	3-Seat Bench
CAL 133	UCAL	+ \$88	+ \$88	+ \$175	+ \$262

Cleaning	Code	Price			
Moisture Barrier		Ottoman	1-Seat Bench	2-Seat Bench	3-Seat Bench
Seat Only	UM2	+ \$59	+ \$59	+ \$118	+ \$177

Fully Upholstered	Code	Price			
Seat and Valance Textile		Ottoman	1-Seat Bench	2-Seat Bench	3-Seat Bench
Fabric/Vinyl Grade 1	FG1/VG1	+ \$0	+ \$0	+ \$0	+ \$0
COM	COM	+ \$23	+ \$25	+ \$30	+ \$35
Fabric/Vinyl Grade 2	FG2/VG2	+ \$23	+ \$25	+ \$30	+ \$35
Fabric/Vinyl Grade 3	FG3/VG3	+ \$68	+ \$75	+ \$90	+ \$105
Fabric/Vinyl Grade 4	FG4/VG4	+ \$113	+ \$125	+ \$150	+ \$175
Fabric/Vinyl Grade 5	FG5/VG5	+ \$169	+ \$188	+ \$225	+ \$263
Fabric/Vinyl Grade 6	FG6/VG6	+ \$248	+ \$275	+ \$330	+ \$385
Fabric/Vinyl Grade 7	FG7/VG7	+ \$349	+ \$388	+ \$465	+ \$543
Leather Grade 1	LG1	+ \$363	+ \$371	+ \$447	+ \$523
COL	COL	+ \$476	+ \$487	+ \$586	+ \$686
Leather Grade 2	LG2	+ \$476	+ \$487	+ \$586	+ \$686
Leather Grade 3	LG3	+ \$657	+ \$672	+ \$809	+ \$947

**5. Material (Cont.)**

Multi-Upholstery	Code	Price			
		Ottoman	1-Seat Bench	2-Seat Bench	3-Seat Bench
Multi-Upholstery Upcharge	UMU	+ \$113	+ \$113	+ \$113	+ \$113
Seat Textile Only		Ottoman	1-Seat Bench	2-Seat Bench	3-Seat Bench
Fabric/Vinyl Grade 1	FG1/VG1	+ \$0	+ \$0	+ \$0	+ \$0
COM	COM	+ \$12	+ \$13	+ \$15	+ \$18
Fabric/Vinyl Grade 2	FG2/VG2	+ \$12	+ \$13	+ \$15	+ \$18
Fabric/Vinyl Grade 3	FG3/VG3	+ \$34	+ \$38	+ \$45	+ \$53
Fabric/Vinyl Grade 4	FG4/VG4	+ \$57	+ \$63	+ \$75	+ \$88
Fabric/Vinyl Grade 5	FG5/VG5	+ \$85	+ \$94	+ \$113	+ \$132
Fabric/Vinyl Grade 6	FG6/VG6	+ \$124	+ \$138	+ \$165	+ \$193
Fabric/Vinyl Grade 7	FG7/VG7	+ \$175	+ \$194	+ \$233	+ \$272
Leather Grade 1	LG1	+ \$182	+ \$186	+ \$224	+ \$262
COL	COL	+ \$238	+ \$244	+ \$293	+ \$343
Leather Grade 2	LG2	+ \$238	+ \$244	+ \$293	+ \$343
Leather Grade 3	LG3	+ \$329	+ \$336	+ \$405	+ \$474
Valance Textile Only		Ottoman	1-Seat Bench	2-Seat Bench	3-Seat Bench
Fabric/Vinyl Grade 1	FG1/VG1	+ \$0	+ \$0	+ \$0	+ \$0
COM	COM	+ \$12	+ \$13	+ \$15	+ \$18
Fabric/Vinyl Grade 2	FG2/VG2	+ \$12	+ \$13	+ \$15	+ \$18
Fabric/Vinyl Grade 3	FG3/VG3	+ \$34	+ \$38	+ \$45	+ \$53
Fabric/Vinyl Grade 4	FG4/VG4	+ \$57	+ \$63	+ \$75	+ \$88
Fabric/Vinyl Grade 5	FG5/VG5	+ \$85	+ \$94	+ \$113	+ \$132
Fabric/Vinyl Grade 6	FG6/VG6	+ \$124	+ \$138	+ \$165	+ \$193
Fabric/Vinyl Grade 7	FG7/VG7	+ \$175	+ \$194	+ \$233	+ \$272
Leather Grade 1	LG1	+ \$182	+ \$186	+ \$224	+ \$262
COL	COL	+ \$238	+ \$244	+ \$293	+ \$343
Leather Grade 2	LG2	+ \$238	+ \$244	+ \$293	+ \$343
Leather Grade 3	LG3	+ \$329	+ \$336	+ \$405	+ \$474

If different fabrics are selected for the seat and valance add the multiple upholstery upcharge (UMU) as well, even if the two fabrics are the same grade.

Please reference the Textile Reference Guide for pricing on fabric over grade 7 and leather over grade 3. Additional CAL 133 information can be found on page 10.

**6. Packaging**

Packaging	Code	Price
Fully Assembled in a Carton	P1	+ \$0

## OTTOMAN AND BENCHES

### SPECIFICATIONS

Model:	CP FS1 Ottoman	CP FS2 SN1 1-Seat Bench
<b>Dimensions</b>		
Seat Width	22"	26"
Seat Depth	22"	24"
Seat Height	18.5"	18.5"
<b>Materials</b>		
COM (Fully Upholstered)	3.2 yd	3.2 yd
COM (Multi-Upholstery) Seat Only	1.9 yd	1.9 yd
Valance Only	1.9 yd	1.9 yd
COL (Fully Upholstered)	49 sq ft	49 sq ft
COL (Multi-Upholstery) Seat Only	29.4 sq ft	29.4 sq ft
Valance Only	29.4 sq ft	29.4 sq ft
<b>Weight and Capacity</b>		
Weight	28 lb	60 lb
Weight Capacity Warranty (Per Seat)	300 lb	300 lb

*NOTE: Yardage requirements for COM and COL are for solid and non-directional fabrics. Additional material may be required for larger repeating patterns.*

### SPECIFICATIONS

Model:	CP FS2 SN2 2-Seat Bench	CP FS2 SN3 3-Seat Bench
<b>Dimensions</b>		
Seat Width	48"	70"
Seat Depth	24"	24"
Seat Height	18.5"	18.5"
<b>Materials</b>		
COM (Fully Upholstered)	3.8 yd	4.4 yd
COM (Multi-Upholstery) Seat Only	2.9 yd	2.9 yd
Valance Only	2.9 yd	2.9 yd
COL (Fully Upholstered)	58.8 sq ft	68.6 sq ft
COL (Multi-Upholstery) Seat Only	44.1 sq ft	44.1 sq ft
Valance Only	44.1 sq ft	44.1 sq ft
<b>Weight and Capacity</b>		
Weight	91 lb	106 lb
Weight Capacity Warranty (Per Seat)	300 lb	300 lb

*NOTE: Yardage requirements for COM and COL are for solid and non-directional fabrics. Additional material may be required for larger repeating patterns.*



2-Seat Bench With Metal Pole Feet

# Envoi

## LOUNGE SEATING

### *Lean back lounge.*

To reach the height of comfort, you should start at its roots. A place where everything feels natural and effortless. Get ready to discover what's possible when innovation comes to life because this is the first-ever flexing solution for lounge. It moves you. It moves with you. Envoi is a pure exposition of comfort-meets-motion with unmatched, unencumbered design.



*Highback With Wood Base*

**EFFECTIVE DECEMBER 1, 2021**

### Featured Models

#### **MIDBACK WITH METAL BASE :: \$1,756**

Midback, 360-degree swivel, charcoal metal base, fully upholstered, grade 1 textile

#### **HIGHBACK WITH METAL BASE :: \$2,130**

Highback, 360-degree swivel, polished aluminum metal base, fully upholstered, grade 3 textile

#### **HIGHBACK WITH WOOD BASE :: \$2,507**



Highback, 360-degree swivel, wood base, fully upholstered, grade 4 textile

## LOUNGE SEATING

### Features

- Designed by Claudio Bellini
- Backrest flexes and moves when you recline
- Petal-like pieces surround with comfort
- Available in midback or highback
- 4-star base available in three wood or metal finishes
- Auto-return cylinder available on metal base only
- 300 lb weight capacity warranty

#### 1. Product

Back Size and Style	Code	Price	
Midback Lounge	ENV BH4	\$1,756	
Highback Lounge	ENV BH5	\$1,897	

#### 2. Base

Cylinder	Code	Price	
360-Degree Swivel	CH5	+ \$0	
Auto-Return, Fixed Height	CH6	+ \$25	

Base Material	Code	Price	
Metal	BMM	+ \$0	
Wood	BMW	+ \$400	

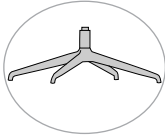
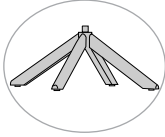
Auto-return cylinder (CH6) is only available with metal base (BMM).

#### 2. Base (Cont.)

Base Color	Code	Price	
<b>Metal Color</b>			
Charcoal	BF04	+ \$0	
Bronze	BF05	+ \$0	
Polished Aluminum	BF07	+ \$113	
<b>Wood Cap Stain</b>			
Uptown	BF08	+ \$0	
Colombian	BF09	+ \$0	
Skyline	BF10	+ \$0	

#### 3. Material

Protection	Code	Price	
<b>Fire Retardancy</b>			
CAL 133	UCAL	+\$262	
<b>Cleaning</b>			
<b>Moisture Barrier</b>			
Seat Only	UM2	+\$59	
Back Only	UM1	+\$59	
Seat and Back	UM3	+\$118	
<b>Fully Upholstered</b>			
<b>Midback (For BH4) Textile</b>			
Fabric/Vinyl Grade 1	FG1/VG1	+ \$0	
COM	COM	+ \$42	
Fabric/Vinyl Grade 2	FG2/VG2	+ \$42	
Fabric/Vinyl Grade 3	FG3/VG3	+ \$112	
Fabric/Vinyl Grade 4	FG4/VG4	+ \$196	
Fabric/Vinyl Grade 5	FG5/VG5	+ \$336	
Fabric/Vinyl Grade 6	FG6/VG6	+ \$476	
Fabric/Vinyl Grade 7	FG7/VG7	+ \$616	
Leather Grade 1	LG1	+ \$900	
COL	COL	+ \$1,140	
Leather Grade 2	LG2	+ \$1,140	
Leather Grade 3	LG3	+ \$1,440	

## LOUNGE SEATING

### 3. Material (Cont.)

Fully Upholstered	Code	Price
<b>Highback (For BH5) Textile</b>		
Fabric/Vinyl Grade 1	FG1/VG1	+ \$0
COM	COM	+ \$45
Fabric/Vinyl Grade 2	FG2/VG2	+ \$45
Fabric/Vinyl Grade 3	FG3/VG3	+ \$120
Fabric/Vinyl Grade 4	FG4/VG4	+ \$210
Fabric/Vinyl Grade 5	FG5/VG5	+ \$360
Fabric/Vinyl Grade 6	FG6/VG6	+ \$510
Fabric/Vinyl Grade 7	FG7/VG7	+ \$660
Leather Grade 1	LG1	+ \$945
COL	COL	+ \$1,197
Leather Grade 2	LG2	+ \$1,197
Leather Grade 3	LG3	+ \$1,512

### 3. Material (Cont.)

Multi-Upholstery	Code	Price
Multi-Upholstery Upcharge	UMU	+ \$75
<b>Midback Textile</b>		<b>Seat Only</b> <b>Back and Arms</b>
Fabric/Vinyl Grade 1	FG1/VG1	+ \$0   + \$0
COM	COM	+ \$15   + \$38
Fabric/Vinyl Grade 2	FG2/VG2	+ \$15   + \$38
Fabric/Vinyl Grade 3	FG3/VG3	+ \$40   + \$104
Fabric/Vinyl Grade 4	FG4/VG4	+ \$70   + \$182
Fabric/Vinyl Grade 5	FG5/VG5	+ \$120   + \$312
Fabric/Vinyl Grade 6	FG6/VG6	+ \$170   + \$443
Fabric/Vinyl Grade 7	FG7/VG7	+ \$220   + \$573
Leather Grade 1	LG1	+ \$315   + \$828
COL	COL	+ \$399   + \$1,049
Leather Grade 2	LG2	+ \$399   + \$1,049
Leather Grade 3	LG3	+ \$504   + \$1,326
<b>Highback (For BH5) Textile</b>		<b>Seat Only</b> <b>Back and Arms</b>
Fabric/Vinyl Grade 1	FG1/VG1	+ \$0   + \$0
COM	COM	+ \$15   + \$41
Fabric/Vinyl Grade 2	FG2/VG2	+ \$15   + \$41
Fabric/Vinyl Grade 3	FG3/VG3	+ \$40   + \$109
Fabric/Vinyl Grade 4	FG4/VG4	+ \$70   + \$192
Fabric/Vinyl Grade 5	FG5/VG5	+ \$120   + \$329
Fabric/Vinyl Grade 6	FG6/VG6	+ \$170   + \$467
Fabric/Vinyl Grade 7	FG7/VG7	+ \$220   + \$604
Leather Grade 1	LG1	+ \$315   + \$866
COL	COL	+ \$399   + \$1,097
Leather Grade 2	LG2	+ \$399   + \$1,097
Leather Grade 3	LG3	+ \$504   + \$1,386

If different fabrics are selected for the seat and back/arms, add the multiple upholstery upcharge as well, even if the fabrics are the same grade.

Please reference the *Textile Reference Guide* for pricing on fabric over grade 7 and leather over grade 3. Additional CAL 133 information can be found on page 10.

### 4. Packaging

Packaging	Code	Price
Partially Assembled in Carton	P3	+ \$0
Assembled in Carton	P1	+ \$80



**SPECIFICATIONS**

Model:	ENV BH4 Midback Lounge	ENV BH5 Highback Lounge
<b>Dimensions</b>		
Height	34.75"	41.5"
Width	27"	27"
Depth	26"	26"
Seat Depth	18"	18"
Seat Height	16.5"	16.5"
Back Height	21.25"	28"
<b>Materials</b>		
COM (Fully Upholstered)	3 yd	3.25 yd
COM (Multi-Upholstery)		
Back and Arms Only	2.5 yd	2.75 yd
Seat Cushion Only	1 yd	1 yd
COL (Fully Upholstered)	50 sq ft	55 sq ft
COL (Multi-Upholstery)		
Back and Arms Only	40 sq ft	45 sq ft
Seat Cushion Only	15 sq ft	15 sq ft
<b>Weight and Capacity</b>		
Weight	42 lb (BMM) 55.5 lb (BMW)	54 lb (BMM) 67.5 lb (BMW)
Weight Capacity Warranty	300 lb	300 lb

*Metal base (BMM). Wood base (BMW).*



*Highback With Metal Base*

# Gobi

## LOUNGE SEATING

### *Huddle with inspiration.*

Work mode. Wait mode. Let's-get-it-done mode. Today's open and collaborative spaces should help you shift spontaneously. And Gobi is the perfect huddle partner. Its sculpted comfort and modern, easygoing design can carry you through the many modes you find yourself in—so that another day at the office feels like anything but.



Charcoal Metal Base

EFFECTIVE DECEMBER 1, 2021

### Featured Models

#### **CHARCOAL METAL BASE :: \$1,576**

Midback, charcoal metal base, free-swivel fixed-height cylinder, fully upholstered, grade 1 textile

#### **POLISHED ALUMINUM BASE :: \$1,924**

Midback, polished aluminum metal base, auto-return fixed-height cylinder, fully upholstered, grade 4 textile

#### **WOOD BASE :: \$2,186**

Midback, free-swivel fixed-height cylinder, wood base, fully upholstered, grade 4 textile



LOUNGE SEATING

Features

- Minimalist design with crisp lines and tailored stitching
- Flared arms allow room for bags, laptops and more
- Soft, sculpted curves provide extra comfort
- Multi-upholstery options on seat cushion
- Bases available in three metal and wood finishes
- Auto-return cylinder available on metal base only
- 300 lb weight capacity warranty

1. Product

Back Size and Style	Code	Price	
Midback Lounge	GBI BH4	\$1,576	

2. Base

Cylinder	Code	Price	
Free Swivel, Fixed Height	CH5	+ \$0	
Auto-Return, Fixed Height	CH6	+ \$25	

Base Material	Code	Price	
Metal	BMM	+ \$0	
Wood	BMW	+ \$400	

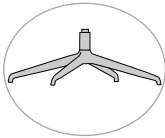
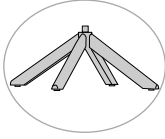
2. Base (Cont.)

Base Color	Code	Price	
<b>Metal Color</b>			
Charcoal	BF04	+ \$0	
Bronze	BF05	+ \$0	
Polished Aluminum	BF07	+ \$113	
<b>Wood Cap Stain</b>			
Uptown	BF08	+ \$0	
Colombian	BF09	+ \$0	
Skyline	BF10	+ \$0	

*Auto-return cylinder (CH6) is only available with metal base (BMM).*

Glides	Code	Price	
Standard Multi-Surface Glides	GL1	+ \$0	

3. Material

Protection	Code	Price	
<b>Fire Retardancy</b>			
CAL 133	UCAL	+\$262	
<b>Cleaning</b>			
<b>Moisture Barrier</b>			
Seat Only	UM2	+\$59	
Back Only	UM1	+\$59	
Seat and Back	UM3	+\$118	
<b>Fully Upholstered</b>			
Fabric/Vinyl Grade 1	FG1/VG1	+ \$0	
COM	COM	+ \$45	
Fabric/Vinyl Grade 2	FG2/VG2	+ \$45	
Fabric/Vinyl Grade 3	FG3/VG3	+ \$120	
Fabric/Vinyl Grade 4	FG4/VG4	+ \$210	
Fabric/Vinyl Grade 5	FG5/VG5	+ \$360	
Fabric/Vinyl Grade 6	FG6/VG6	+ \$510	
Fabric/Vinyl Grade 7	FG7/VG7	+ \$660	
Leather Grade 1	LG1	+ \$1,181	
COL	COL	+ \$1,496	
Leather Grade 2	LG2	+ \$1,496	
Leather Grade 3	LG3	+ \$1,890	

LOUNGE SEATING

3. Material (Cont.)

Multi-Upholstery	Code	Price	
Multi-Upholstery Upcharge	UMU	+ \$75	
<b>Seat Shell Textile Only</b>			
Fabric/Vinyl Grade 1	FG1/VG1	+ \$0	
COM	COM	+ \$30	
Fabric/Vinyl Grade 2	FG2/VG2	+ \$30	
Fabric/Vinyl Grade 3	FG3/VG3	+ \$80	
Fabric/Vinyl Grade 4	FG4/VG4	+ \$140	
Fabric/Vinyl Grade 5	FG5/VG5	+ \$240	
Fabric/Vinyl Grade 6	FG6/VG6	+ \$340	
Fabric/Vinyl Grade 7	FG7/VG7	+ \$440	
Leather Grade 1	LG1	+ \$788	
COL	COL	+ \$998	
Leather Grade 2	LG2	+ \$998	
Leather Grade 3	LG3	+ \$1,260	

3. Material (Cont.)

Multi-Upholstery	Code	Price	
<b>Seat Cushion Textile Only</b>			
Fabric/Vinyl Grade 1	FG1/VG1	+ \$0	
COM	COM	+ \$15	
Fabric/Vinyl Grade 2	FG2/VG2	+ \$15	
Fabric/Vinyl Grade 3	FG3/VG3	+ \$40	
Fabric/Vinyl Grade 4	FG4/VG4	+ \$70	
Fabric/Vinyl Grade 5	FG5/VG5	+ \$120	
Fabric/Vinyl Grade 6	FG6/VG6	+ \$170	
Fabric/Vinyl Grade 7	FG7/VG7	+ \$220	
Leather Grade 1	LG1	+ \$394	
COL	COL	+ \$499	
Leather Grade 2	LG2	+ \$499	
Leather Grade 3	LG3	+ \$630	

*Textiles approved for Nano and Paseo apply to Gobi. Refer to textile compatibility tool for up-to-date offerings.*

*If different fabrics are selected for the seat cushion and shell, add the multiple upholstery upcharge as well, even if the fabrics are the same grade.*

*Please reference the Textile Reference Guide for pricing on fabric over grade 7 and leather over grade 3. Additional CAL 133 information can be found on page 10.*

4. Packaging

Packaging	Code	Price	
Partially Assembled in Carton	P3	+ \$0	
Assembled in Carton	P1	+ \$80	



Wood Base

**SPECIFICATIONS**

<b>Model:</b>	<b>GOBI BH4 Midback Lounge</b>
<b>Dimensions</b>	
Height	31.5"
Width	30.25"
Depth	31"
Seat Depth	19"
Seat Height	17.25"
Back Height	21.5"
<b>Materials</b>	
COM (Fully Upholstered)	3.5 yd
COM (Multi-Upholstery)	
Seat Shell Only	2.8 yd
Seat Cushion Only	1 yd
COL (Single Upholstery)	55 sq ft
COL (Multi-Upholstered)	
Seat Shell Only	48 sq ft
Seat Cushion Only	15 sq ft
<b>Weight and Capacity</b>	
Weight	37.5 lb (BMM) 51 lb (BMW)
Weight Capacity Warranty	300 lb

*Metal base (BMM). Wood base (BMW).*

# Nano

## MODULAR LOUNGE TYPICALS

### *Easy from every angle.*

Meet Nano, our uniquely designed and easy-to-spec modular lounge collection. Featuring a triangle, diamond, trapezoid and boomerang, Nano's geometric shapes make on-the-spot configuration easy and fun. Create a new, one-of-a-kind look every time in thousands of combinations.

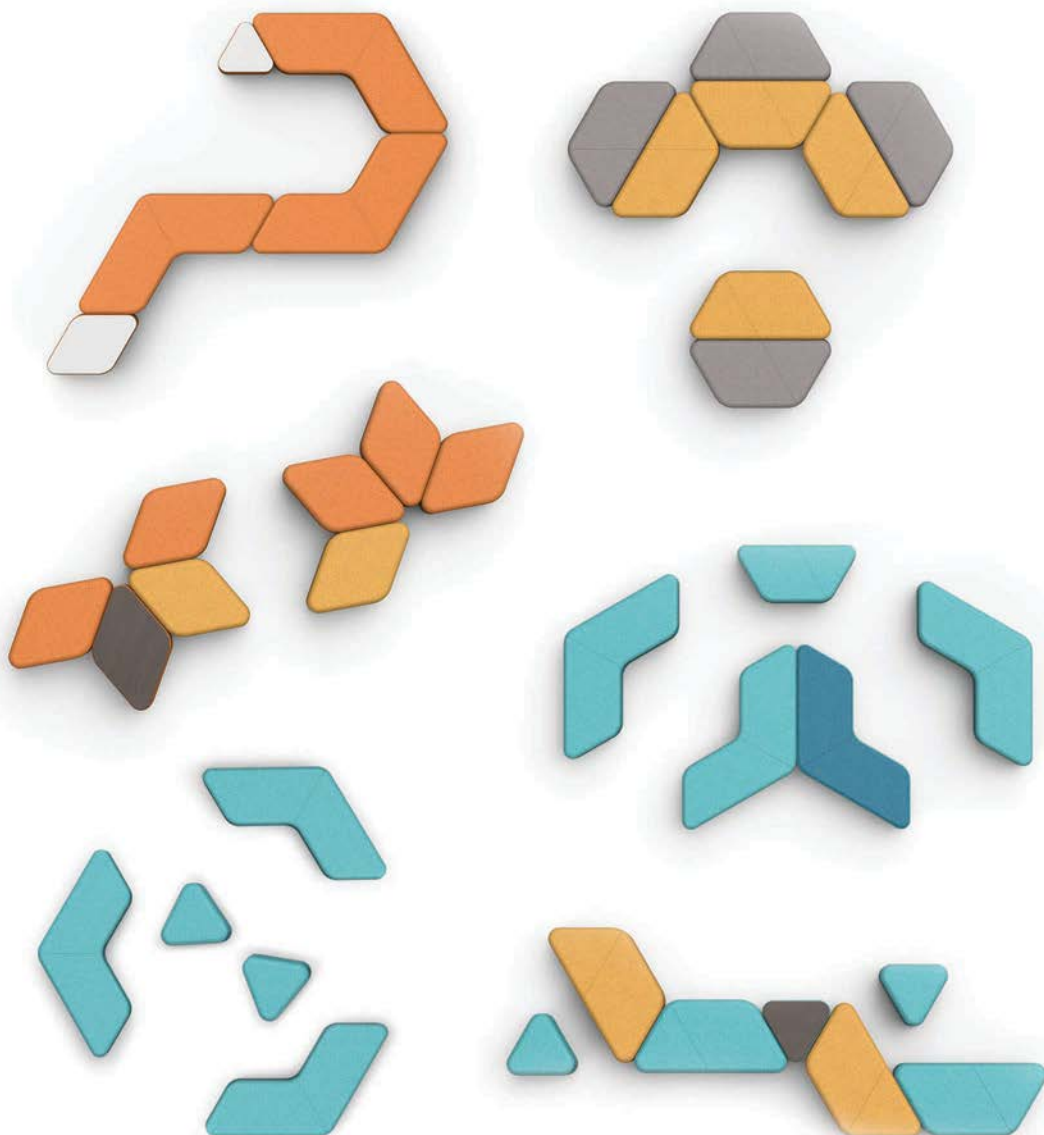

### Typical 1

Line	Category	Part Number	Qty	Description	Unit Price	Ext. Price	
1	Table	NNO FS14 TM4 TSS2 FG1 LS1	1	Diamond, Solid Surface Tabletop, Fixed Glides, Fully Upholstered, Grade 1 Textile	\$1,613	\$1,613	
2	Seating	NNO FS16 TM0 FG1 LS1	3	Boomerang, Fixed Glides, Fully Upholstered, Grade 1 Textile	\$2,865	\$8,595	
3	Table	NNO FS13 TM4 TSS2 FG1 LS1	1	Triangle, Solid Surface Tabletop, Fixed Glides, Fully Upholstered, Grade 1 Textile	\$1,137	\$1,137	

**TOTAL: \$11,345**

### Typical 2

Line	Category	Part Number	Qty	Description	Unit Price	Ext. Price	
1	Seating	NNO FS16 TM0 FG1 LS1	4	Boomerang, Fixed Glides, Fully Upholstered, Grade 1 Textile	\$2,865	\$11,460	
2	Seating	NNO FS15 TM0 FG1 LS1	1	Trapezoid, Fixed Glides, Fully Upholstered, Grade 1 Textile	\$1,213	\$1,213	

**TOTAL: \$12,673**

### Typical 3

Line	Category	Part Number	Qty	Description	Unit Price	Ext. Price	
1	Seating	NNO FS13 TM0 FG1 LS1	2	Triangle, Fixed Glides, Fully Upholstered, Grade 1 Textile	\$497	\$994	
2	Table	NNO FS13 TM3 TL15 FG1 LS1	1	Triangle, Laminate Tabletop, Fixed Glides, Fully Upholstered, Grade 1 Textile	\$637	\$637	
3	Seating	NNO FS15 TM0 FG1 LS1	4	Trapezoid, Fixed Glides, Fully Upholstered, Grade 1 Textile	\$1,213	\$4,852	

**TOTAL: \$6,483**

### Typical 4

Line	Category	Part Number	Qty	Description	Unit Price	Ext. Price	
1	Seating	NNO FS14 TM0 FG1 LS1	7	Diamond, Fixed Glides, Fully Upholstered, Grade 1 Textile	\$717	\$5,019	
2	Table	NNO FS14 TM3 TL15 FG1 LS1	1	Diamond, Laminate Tabletop, Fixed Glides, Fully Upholstered, Grade 1 Textile	\$913	\$913	

**TOTAL: \$5,932**

### Typical 5

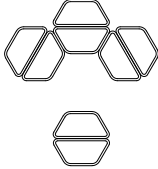
Line	Category	Part Number	Qty	Description	Unit Price	Ext. Price	
1	Seating	NNO FS15 TM0 FG1 LS1	8	Trapezoid, Fixed Glides, Fully Upholstered, Grade 1 Textile	\$1,213	\$9,704	
						<b>TOTAL: \$9,704</b>	

### Typical 6

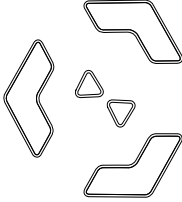
Line	Category	Part Number	Qty	Description	Unit Price	Ext. Price	
1	Seating	NNO FS16 TM0 FG1 LS1	3	Boomerang, Fixed Glides, Fully Upholstered, Grade 1 Textile	\$2,865	\$8,595	
2	Seating	NNO FS13 TM0 FG1 LS1	2	Triangle, Fixed Glides, Fully Upholstered, Grade 1 Textile	\$497	\$994	
						<b>TOTAL: \$9,589</b>	

### Typical 7

Line	Category	Part Number	Qty	Description	Unit Price	Ext. Price	
1	Table	NNO FS13 TM3 TL13 FG1 LS1	2	Triangle, Laminate Tabletop, Fixed Glides, Fully Upholstered, Grade 1 Textile	\$637	\$1,274	
2	Seating	NNO FS14 TM0 FG1 LS1	2	Diamond, Fixed Glides, Fully Upholstered, Grade 1 Textile	\$717	\$1,434	
3	Seating	NNO FS15 TM0 FG1 LS1	4	Trapezoid, Fixed Glides, Fully Upholstered, Grade 1 Textile	\$1,213	\$4,852	
						<b>TOTAL: \$7,560</b>	

### Typical 8

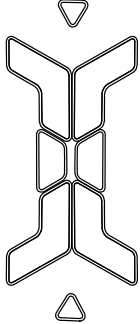
Line	Category	Part Number	Qty	Description	Unit Price	Ext. Price	
1	Seating	NNO FS13 TM0 FG1 LS1	2	Triangle, Fixed Glides, Fully Upholstered, Grade 1 Textile	\$497	\$994	
2	Seating	NNO FS16 TM0 FG1 LS1	4	Boomerang, Fixed Glides, Fully Upholstered, Grade 1 Textile	\$2,865	\$11,460	
3	Seating	NNO FS15 TM0 FG1 LS1	2	Trapezoid, Fixed Glides, Fully Upholstered, Grade 1 Textile	\$1,213	\$2,426	
						<b>TOTAL: \$14,880</b>	

### Typical 9

Line	Category	Part Number	Qty	Description	Unit Price	Ext Price	
1	Table	NNO FS13 TM4 TSS2 FG1 LS1	5	Triangle, Solid Surface Tabletop, Fixed Glides, Fully Upholstered, Grade 1 Textile	\$1,137	\$5,685	
2	Seating	NNO FS16 TM0 FG1 LS1	3	Boomerang, Fixed Glides, Fully Upholstered, Grade 1 Textile	\$2,865	\$8,595	
3	Seating	NNO FS15 TM0 FG1 LS1	6	Trapezoid, Fixed Glides, Fully Upholstered, Grade 1 Textile	\$1,213	\$7,278	
						<b>TOTAL: \$21,558</b>	

### Typical 10

Line	Category	Part Number	Qty	Description	Unit Price	Ext Price	
1	Seating	NNO FS15 TM0 FG1 LS1	4	Trapezoid, Fixed Glides, Fully Upholstered, Grade 1 Textile	\$1,213	\$4,852	
2	Table	NNO FS13 TM4 TSS2 FG1 LS1	2	Triangle, Solid Surface Tabletop, Fixed Glides, Fully Upholstered, Grade 1 Textile	\$1,137	\$2,274	
3	Seating	NNO FS14 TM0 FG1 LS1	1	Diamond, Fixed Glides, Fully Upholstered, Grade 1 Textile	\$717	\$717	
4	Table	NNO FS14 TM4 TSS2 FG1 LS1	1	Diamond, Solid Surface Tabletop, Fixed Glides, Fully Upholstered, Grade 1 Textile	\$1,613	\$1,613	
						<b>TOTAL: \$9,456</b>	

### Typical 11

Line	Category	Part Number	Qty	Description	Unit Price	Ext Price	
1	Table	NNO FS13 TM3 TL14 FG1 LS1	2	Triangle, Laminate Tabletop, Fixed Glides, Fully Upholstered, Grade 1 Textile	\$637	\$1,274	
2	Seating	NNO FS15 TM0 FG1 LS1	4	Trapezoid, Fixed Glides, Fully Upholstered, Grade 1 Textile	\$1,213	\$4,852	
3	Seating	NNO FS14 TM0 FG1 LS1	1	Diamond, Fixed Glides, Fully Upholstered, Grade 1 Textile	\$717	\$717	
4	Table	NNO FS14 TM3 TL14 FG1 LS1	1	Diamond, Laminate Tabletop, Fixed Glides, Fully Upholstered, Grade 1 Textile	\$913	\$913	
						<b>TOTAL: \$7,756</b>	

### Typical 12

Line	Category	Part Number	Qty	Description	Unit Price	Ext. Price	
1	Seating	NNO FS15 TM0 FG1 LS1	4	Trapezoid, Fixed Glides, Fully Upholstered, Grade 1 Textile	\$1,213	\$4,852	
2	Table	NNO FS13 TM4 TSS2 FG1 LS1	1	Triangle, Solid Surface Tabletop, Fixed Glides, Fully Upholstered, Grade 1 Textile	\$1,137	\$1,137	
3	Seating	NNO FS14 TM0 FG1 LS1	1	Diamond, Fixed Glides, Fully Upholstered, Grade 1 Textile	\$717	\$717	
4	Table	NNO FS14 TM4 TSS2 FG1 LS1	1	Diamond, Solid Surface Tabletop, Fixed Glides, Fully Upholstered, Grade 1 Textile	\$1,613	\$1,613	
5	Seating	NNO FS13 TM0 FG1 LS1	1	Triangle, Fixed Glides, Fully Upholstered, Grade 1 Textile	\$497	\$497	

**TOTAL: \$8,816**

### Typical 13

Line	Category	Part Number	Qty	Description	Unit Price	Ext. Price	
1	Seating	NNO FS16 TM0 FG1 LS1	2	Boomerang, Fixed Glides, Fully Upholstered, Grade 1 Textile	\$2,865	\$5,730	
2	Seating	NNO FS15 TM0 FG1 LS1	2	Trapezoid, Fixed Glides, Fully Upholstered, Grade 1 Textile	\$1,213	\$2,426	

**TOTAL: \$8,156**

### Typical 14

Line	Category	Part Number	Qty	Description	Unit Price	Ext. Price	
1	Seating	NNO FS15 TM0 FG1 LS1	4	Trapezoid, Fixed Glides, Fully Upholstered, Grade 1 Textile	\$1,213	\$4,852	
2	Seating	NNO FS14 TM0 FG1 LS1	1	Diamond, Fixed Glides, Fully Upholstered, Grade 1 Textile	\$717	\$717	
3	Table	NNO FS14 TM3 TL13 FG1 LS1	1	Diamond, Laminate Tabletop, Fixed Glides, Fully Upholstered, Grade 1 Textile	\$913	\$913	
4	Table	NNO FS13 TM3 TL13 FG1 LS1	1	Triangle, Laminate Tabletop, Fixed Glides, Fully Upholstered, Grade 1 Textile	\$637	\$637	
5	Seating	NNO FS13 TM0 FG1 LS1	1	Triangle, Fixed Glides, Fully Upholstered, Grade 1 Textile	\$497	\$497	

**TOTAL: \$7,616**

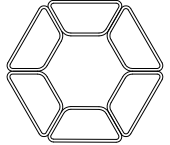

**Typical 15**

Line	Category	Part Number	Qty	Description	Unit Price	Ext. Price	
1	Seating	NNO FS15 TM0 FG1 LS1	6	Trapezoid, Fixed Glides, Fully Upholstered, Grade 1 Textile	\$1,213	\$7,278	
						<b>TOTAL: \$7,278</b>	

**Typical 16**

Line	Category	Part Number	Qty	Description	Unit Price	Ext. Price	
1	Seating	NNO FS15 TM0 FG1 LS1	4	Trapezoid, Fixed Glides, Fully Upholstered, Grade 1 Textile	\$1,213	\$4,852	
2	Seating	NNO FS14 TM0 FG1 LS1	1	Diamond, Fixed Glides, Fully Upholstered, Grade 1 Textile	\$717	\$717	
3	Table	NNO FS14 TM3 TL15 FG1 LS1	1	Diamond, Laminate Tabletop, Fixed Glides, Fully Upholstered, Grade 1 Textile	\$913	\$913	
4	Seating	NNO FS13 TM0 FG1 LS1	2	Trangle, Fixed Glides, Fully Upholstered, Grade 1 Textile	\$497	\$994	
						<b>TOTAL: \$7,476</b>	

# Nano

## MODULAR LOUNGE

*Easy from every angle.*

Meet Nano, our uniquely designed and easy-to-spec modular lounge collection. Featuring a triangle, diamond, trapezoid and boomerang, Nano's geometric shapes make on-the-spot configuration easy and fun. Create a new, one-of-a-kind look every time in thousands of combinations.



*Boomerang*

**EFFECTIVE DECEMBER 1, 2021**

### Featured Models

**TRIANGLE TABLE :: \$694**

Triangle with laminate tabletop, grade 3 textiles

**TRAPEZOID :: \$1,430**

Trapezoid, multi-upholstery, grade 3 textiles

**BOOMERANG :: \$3,160**

Boomerang, multi-upholstery, grade 2 chassis, grade 4 seat

### Features

- Four shapes for endless configuration possibilities
- Effortless and fun to design
- Reconfigurable on-the-spot to adapt to any space
- Triangle and diamond shapes feature two solid surface and five laminate tabletop options to enhance functionality
- Mobile and easy to move, or make permanent with ganging brackets
- 400 lb weight capacity warranty (per seat position)



Triangle Table

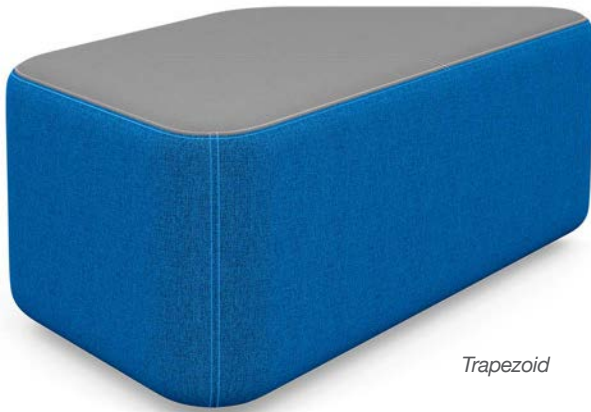

Trapezoid

### 1. Product

Model	Code	Price	
Triangle	NNO FS13	\$497	
Diamond	NNO FS14	\$717	
Trapezoid	NNO FS15	\$1,213	
Boomerang	NNO FS16	\$2,865	

### 2. Tabletop

Tabletop Material	Code	Price	
		Triangle	Diamond
No Tabletop	TM0	+ \$0	+ \$0
Laminate	TM3	+ \$140	+ \$196
Solid Surface	TM4	+ \$640	+ \$896
Tabletop Finish		Price	
Laminate Finish			
Field Elm	TL13	+ \$0	
Uptown Walnut	TL14	+ \$0	
Skyline Walnut	TL15	+ \$0	
Frosty White	TL16	+ \$0	
Classic Linen	TL17	+ \$0	
Solid Surface Color			
Designer White	TSS2	+ \$0	
Cameo White	TSS1	+ \$0	

Tabletops available on triangle and diamond models only.

3. Material

Protection		Code		Price			
CAL 133		Triangle	Triangle Table	Diamond	Diamond Table	Trapezoid	Boomerang
CAL 133	UCAL	+ \$88	+ \$88	+ \$175	+ \$175	+ \$262	+ \$494
Cleaning		Code		Price			
Moisture Barrier		Triangle	Triangle Table	Diamond	Diamond Table	Trapezoid	Boomerang
Seat	UM2	+ \$35	N/A	+ \$59	N/A	+ \$118	+ \$177
Fully Upholstered		Code		Price			
Seat and Chassis		Triangle	Triangle Table	Diamond	Diamond Table	Trapezoid	Boomerang
Fabric/Vinyl Grade 1	FG1/VG1	+ \$0	+ \$0	+ \$0	+ \$0	+ \$0	+ \$0
COM	COM	+ \$40	+ \$36	+ \$61	+ \$40	+ \$77	+ \$135
Fabric/Vinyl Grade 2	FG2/VG2	+ \$40	+ \$36	+ \$61	+ \$40	+ \$77	+ \$135
Fabric/Vinyl Grade 3	FG3/VG3	+ \$63	+ \$57	+ \$94	+ \$63	+ \$120	+ \$210
Fabric/Vinyl Grade 4	FG4/VG4	+ \$90	+ \$81	+ \$135	+ \$90	+ \$171	+ \$300
Fabric/Vinyl Grade 5	FG5/VG5	+ \$135	+ \$121	+ \$202	+ \$135	+ \$256	+ \$450
Fabric/Vinyl Grade 6	FG6/VG6	+ \$180	+ \$162	+ \$270	+ \$180	+ \$342	+ \$600
Fabric/Vinyl Grade 7	FG7/VG7	+ \$225	+ \$202	+ \$337	+ \$225	+ \$427	+ \$750
Multi-Upholstery		Code		Price			
		Triangle	Triangle Table	Diamond	Diamond Table	Trapezoid	Boomerang
Multi-Upholstery Upcharge	UMU	+ \$75	N/A	+ \$75	N/A	+ \$75	+ \$75
Seat Only		Code		Price			
		Triangle	Triangle Table	Diamond	Diamond Table	Trapezoid	Boomerang
Fabric/Vinyl Grade 1	FG1/VG1	+ \$0	N/A	+ \$0	N/A	+ \$0	+ \$0
COM	COM	+ \$19	N/A	+ \$34	N/A	+ \$31	+ \$61
Fabric/Vinyl Grade 2	FG2/VG2	+ \$19	N/A	+ \$34	N/A	+ \$31	+ \$61
Fabric/Vinyl Grade 3	FG3/VG3	+ \$29	N/A	+ \$52	N/A	+ \$48	+ \$94
Fabric/Vinyl Grade 4	FG4/VG4	+ \$42	N/A	+ \$75	N/A	+ \$69	+ \$135
Fabric/Vinyl Grade 5	FG5/VG5	+ \$63	N/A	+ \$112	N/A	+ \$103	+ \$202
Fabric/Vinyl Grade 6	FG6/VG6	+ \$84	N/A	+ \$150	N/A	+ \$138	+ \$270
Fabric/Vinyl Grade 7	FG7/VG7	+ \$105	N/A	+ \$187	N/A	+ \$172	+ \$337
Chassis Only		Code		Price			
		Triangle	Triangle Table	Diamond	Diamond Table	Trapezoid	Boomerang
Fabric/Vinyl Grade 1	FG1/VG1	+ \$0	N/A	+ \$0	N/A	+ \$0	+ \$0
COM	COM	+ \$36	N/A	+ \$40	N/A	+ \$61	+ \$85
Fabric/Vinyl Grade 2	FG2/VG2	+ \$36	N/A	+ \$40	N/A	+ \$61	+ \$85
Fabric/Vinyl Grade 3	FG3/VG3	+ \$57	N/A	+ \$63	N/A	+ \$94	+ \$132
Fabric/Vinyl Grade 4	FG4/VG4	+ \$81	N/A	+ \$90	N/A	+ \$135	+ \$189
Fabric/Vinyl Grade 5	FG5/VG5	+ \$121	N/A	+ \$135	N/A	+ \$202	+ \$283
Fabric/Vinyl Grade 6	FG6/VG6	+ \$162	N/A	+ \$180	N/A	+ \$270	+ \$378
Fabric/Vinyl Grade 7	FG6/VG7	+ \$202	N/A	+ \$225	N/A	+ \$337	+ \$472

Moisture barrier (UM2) seat is not available with tabletop (TM3/TM4). If different fabrics are selected for the seat and chassis, add the multiple upholstery upcharge as well. Please reference the Textile Reference Guide for pricing on fabric over grade 7 and leather over grade 3. Additional CAL 133 information can be found on page 10.

### 4. Glides

Glide Options	Code	Price
Fixed Glides	LS1	+ \$0

### 5. Options

Accessories	Code	Price
One Ganging Bracket (Attaches to Either Side)	XGV	+ \$52

Trapezoid and boomerang accommodate up to two ganging units on the 52" sides.

### 6. Packaging

Packaging	Code	Price
Fully Assembled in a Carton	P1	+ \$0

### SPECIFICATIONS

Model:	NNO FS13 Triangle	NNO FS14 Diamond	NNO FS15 Trapezoid	NNO FS16 Boomerang
<b>Dimensions</b>				
Height (TM0)	17"	17"	17"	17"
Height (TM3/TM4)	17"	17"	—	—
Width	23"	37.5"	52"	81"
Depth	21"	25"	25"	50"
Weight	21 lb	32 lb	45 lb	92 lb
<b>Materials</b>				
COM (Fully Upholstered)	2 yd	3 yd	3.5 yd	6.5 yd
COM (Multi-Upholstery)				
Seat Only	1 yd	1.5 yd	1.5 yd	3 yd
Chassis Only	2 yd	2 yd	3 yd	4 yd
<b>Weight and Capacity</b>				
Weight (TM3)	31.5 lb	54.5 lb	—	—
Weight (TM4)	30 lb	51.1 lb	—	—
Weight Capacity Warranty	400 lb	400 lb	800 lb	1200 lb

No tabletop (TM0). Solid surface tabletop (TM4). Laminate tabletop (TM3).

Yardage requirements for COM are for solid and non-directional fabrics. Additional material may be required for larger repeating patterns.

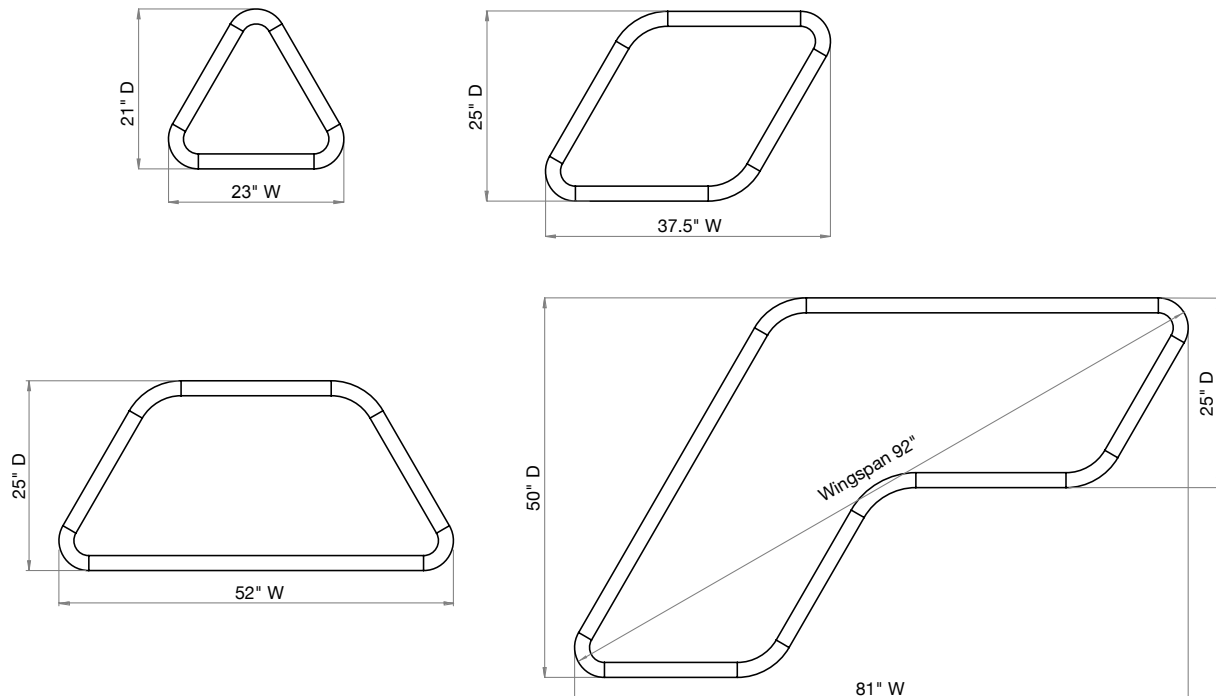

# Paséa

## MODULAR LOUNGE TYPICALS

### *Lounge that works.*

Paséa features tapered angles and comfort scaling for a lightweight, refined style while promoting an active working posture so that you get our award-winning task chair performance away from your desk.

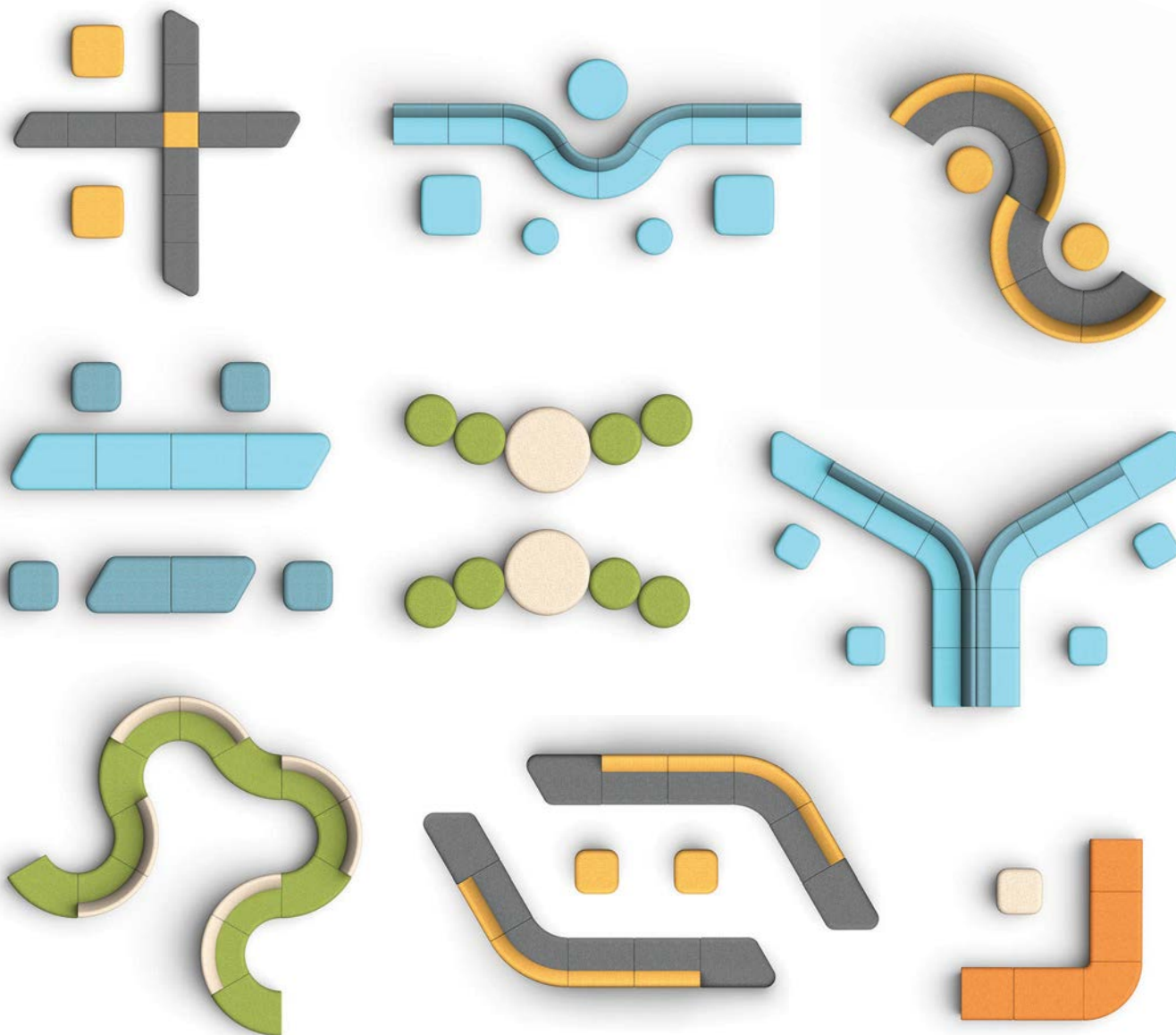

**Typical 1**

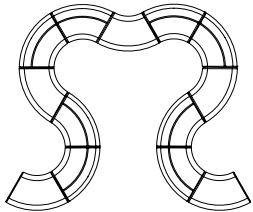
Line	Category	Part Number	Qty	Description	Unit Price	Ext Price	
1	Seating	PAS FS17 SS3	8	120-Degree Inner Seat, Fully Upholstered, Grade 1 Textile	\$2,542	\$20,336	
2	Seating	PAS FS2 BNS6	5	120° Bench, Fully Upholstered, Grade 1 Textile	\$1,906	\$9,530	

**TOTAL: \$29,866**

**Typical 2**

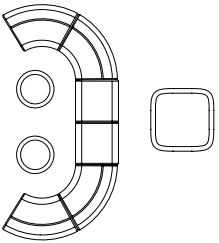
Line	Category	Part Number	Qty	Description	Unit Price	Ext Price	
1	Seating	PAS FS17 SS3	4	120° Inner Seat, Fully Upholstered, Grade 1 Textile	\$2,542	\$10,168	
2	Seating	PAS FS2 BNS1	2	Single Bench, Fully Upholstered, Grade 1 Textile	\$1,060	\$2,120	
3	Seating	PAS FS1 OS1	2	Mini Round Ottoman, Fully Upholstered, Grade 1 Textile	\$636	\$1,272	
4	Seating	PAS FS1 OS4	1	Large Square Ottoman, Fully Upholstered, Grade 1 Textile	\$1,218	\$1,218	

**TOTAL: \$14,778**

**Typical 3**

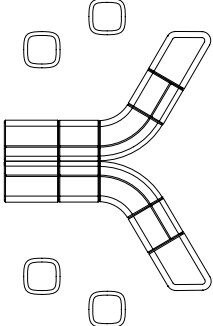
Line	Category	Part Number	Qty	Description	Unit Price	Ext Price	
1	Seating	PAS FS17 SS2	2	1.5 Seat, Fully Upholstered, Grade 1 Textile	\$1,694	\$3,388	
2	Seating	PAS FS17 SS1	4	Single Seat, Fully Upholstered, Grade 1 Textile	\$1,378	\$5,512	
3	Seating	PAS FS17 SS3	2	120° Inner Seat, Fully Upholstered, Grade 1 Textile	\$2,542	\$5,084	
4	Seating	PAS FS2 BNS3	1	Right-Angled End Bench, Fully Upholstered, Grade 1 Textile	\$1,316	\$1,316	
5	Seating	PAS FS2 BNS4	1	Left-Angled End Bench, Fully Upholstered, Grade 1 Textile	\$1,316	\$1,316	
6	Seating	PAS FS1 OS3	4	Mini Square Ottoman, Fully Upholstered, Grade 1 Textile	\$636	\$2,544	

**TOTAL: \$19,160**

**Typical 4**

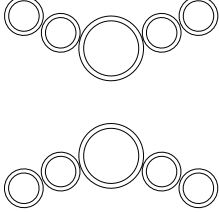
Line	Category	Part Number	Qty	Description	Unit Price	Ext Price	
1	Seating	PAS FS1 OS1	8	Mini Round Ottoman, Fully Upholstered, Grade 1 Textile	\$636	\$5,088	
2	Seating	PAS FS1 OS2	2	Large Round Ottoman, Fully Upholstered, Grade 1 Textile	\$1,218	\$2,436	

**TOTAL: \$7,524**

**Typical 5**

Line	Category	Part Number	Qty	Description	Unit Price	Ext Price	
1	Seating	PAS FS1 OS1	2	Mini Round Ottoman, Fully Upholstered, Grade 1 Textile	\$636	\$1,272	
2	Seating	PAS FS1 OS4	2	Large Square Ottoman, Fully Upholstered, Grade 1 Textile	\$1,218	\$2,436	
3	Seating	PAS FS17 SS4	2	120-Degree Outer Seat, Fully Upholstered, Grade 1 Textile	\$2,542	\$5,084	
4	Seating	PAS FS17 SS3	2	120-Degree Inner Seat, Fully Upholstered, Grade 1 Textile	\$2,542	\$5,084	
5	Seating	PAS FS17 SS2	4	1.5 Seat, Fully Upholstered, Grade 1 Textile	\$1,694	\$6,776	
6	Seating	PAS FS1 OS2	1	Large Round Ottoman, Fully Upholstered, Grade 1 Textile	\$1,218	\$1,218	

**TOTAL: \$21,870**

**Typical 6**

Line	Category	Part Number	Qty	Description	Unit Price	Ext Price	
1	Seating	PAS FS2 BNS1	2	Single Bench, Fully Upholstered, Grade 1 Textile	\$1,060	\$2,120	
2	Seating	PAS FS2 BNS2	2	1.5 Bench, Fully Upholstered, Grade 1 Textile	\$1,378	\$2,756	
3	Seating	PAS FS2 BNS5	1	90-Degree Corner Bench, Fully Upholstered, Grade 1 Textile	\$1,906	\$1,906	
4	Seating	PAS FS1 OS3	1	Mini Square Ottoman, Fully Upholstered, Grade 1 Textile	\$636	\$636	

**TOTAL: \$7,418**

**Typical 7**

Line	Category	Part Number	Qty	Description	Unit Price	Ext Price	
1	Seating	PAS FS17 SS3	6	120-Degree Inner Seat, Fully Upholstered, Grade 1 Textile	\$2,542	\$15,252	
2	Seating	PAS FS1 OS1	2	Mini Round Ottoman, Fully Upholstered, Grade 1 Textile	\$636	\$1,272	

**TOTAL: \$16,524**



**Typical 8**

Line	Category	Part Number	Qty	Description	Unit Price	Ext Price	
1	Seating	PAS FS2 BNS2	4	1.5 Bench, Fully Upholstered, Grade 1 Textile	\$1,378	\$5,512	
2	Seating	PAS FS17 SS3	6	120-Degree Inner Seat, Fully Upholstered, Grade 1 Textile	\$2,542	\$15,252	
3	Seating	PAS FS1 OS1	2	Mini Round Ottoman, Fully Upholstered, Grade 1 Textile	\$636	\$1,272	

**TOTAL: \$22,036**

**Typical 9**

Line	Category	Part Number	Qty	Description	Unit Price	Ext Price	
1	Seating	PAS FS17 SS3	4	120-Degree Inner Seat, Fully Upholstered, Grade 1 Textile	\$2,542	\$10,168	
2	Seating	PAS FS2 BNS6	2	120-Degree Bench, Fully Upholstered, Grade 1 Textile	\$1,906	\$3,812	
3	Seating	PAS FS1 OS1	2	Mini Round Ottoman, Fully Upholstered, Grade 1 Textile	\$636	\$1,272	

**TOTAL: \$15,252**

**Typical 10**

Line	Category	Part Number	Qty	Description	Unit Price	Ext Price	
1	Seating	PAS FS17 SS2	8	1.5 Seat, Fully Upholstered, Grade 1 Textile	\$1,694	\$13,552	
2	Seating	PAS FS2 BNS5	2	90-Degree Corner Bench, Fully Upholstered, Grade 1 Textile	\$1,919	\$3,838	
3	Seating	PAS FS1 OS4	2	Large Square Ottoman, Fully Upholstered, Grade 1 Textile	\$1,218	\$2,436	

**TOTAL: \$19,826**

**Typical 11**

Line	Category	Part Number	Qty	Description	Unit Price	Ext Price	
1	Seating	PAS FS1 OS1	3	Mini Round Ottoman, Fully Upholstered, Grade 1 Textile	\$636	\$1,908	
2	Seating	PAS FS2 BNS6	5	120-Degree Bench, Fully Upholstered, Grade 1 Textile	\$1,906	\$9,530	
3	Seating	PAS FS1 OS3	2	Mini Square Ottoman, Fully Upholstered, Grade 1 Textile	\$636	\$1,272	

**TOTAL: \$12,710**

**Typical 12**

Line	Category	Part Number	Qty	Description	Unit Price	Ext. Price	
1	Seating	PAS FS1 OS3	4	Mini Square Ottoman, Fully Upholstered, Grade 1 Textile	\$636	\$2,544	
2	Seating	PAS FS2 BNS4	4	Left-Angled End Bench, Fully Upholstered, Grade 1 Textile	\$1,316	\$5,264	
3	Seating	PAS FS2 BNS2	2	1.5 Bench, Fully Upholstered, Grade 1 Textile	\$1,378	\$2,756	

**TOTAL: \$10,564**

**Typical 13**

Line	Category	Part Number	Qty	Description	Unit Price	Ext. Price	
1	Seating	PAS FS1 OS1	3	Mini Round Ottoman, Fully Upholstered, Grade 1 Textile	\$636	\$1,908	
2	Seating	PAS FS17 SS4	3	120-Degree Outer Seat, Fully Upholstered, Grade 1 Textile	\$2,542	\$7,626	

**TOTAL: \$9,534**

# Paséa

## MODULAR LOUNGE

### *Lounge that works.*

Work, wait, welcome or wind down, experience the freedom to do anything in a single solution. The tapered base, comfort-scaled seat and built-in backrest with lumbar curve promote an active working posture and lasting support. Rethink what a lounge collection can (and should) be with Paséa.



*Single Seat*

**EFFECTIVE DECEMBER 1, 2021**

### Featured Models

**SINGLE BENCH :: \$1,127**

Single seat bench, fully upholstered, grade 3 seat textile

**SINGLE SEAT :: \$1,572**

Single seat, multi-upholstery, grade 3 seat and back textile

**120° SEAT :: \$2,869**

120° inner seat, multi-upholstery, grade 4 seat and back textile

### Features



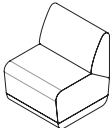
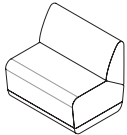
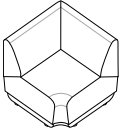
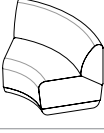
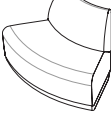

- Choose from a wide variety of benches and seats
- Build using right- or left-angled, 90- or 120-degree pieces
- Configure rectilinear and curvilinear setups with modular seats and benches
- Promote an active working posture with built-in lumbar curve and comfort-scaled seat
- Blend with any environment using graphite or slate base colors

- Add brilliant diamond-cut details with multi-upholstery
- Provide extra convenience with power options
- Adjustable glides standard on modular lounge models
- 400 lb weight capacity warranty (per seat)

#### 1. Product

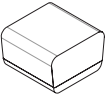
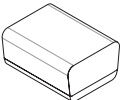
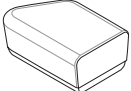
Model	Code	Price	
<b>Seat</b>			
Single Seat	PAS FS17 SS1	\$1,378	
1.5 Seat	PAS FS17 SS2	\$1,694	
90-Degree Corner Seat	PAS FS17 SS5	\$2,097	
120-Degree Inner Seat	PAS FS17 SS3	\$2,542	
120-Degree Outer Seat	PAS FS17 SS4	\$2,542	

#### 1. Product (Cont.)



Model	Code	\$2,542	
<b>Bench</b>			
Single Bench	PAS FS2 BNS1	\$1,060	
1.5 Bench	PAS FS2 BNS2	\$1,378	
Right-Angled End Bench	PAS FS2 BNS3	\$1,316	
Left-Angled End Bench	PAS FS2 BNS4	\$1,316	
90-Degree Corner Bench	PAS FS2 BNS5	\$1,906	
120-Degree Bench	PAS FS2 BNS6	\$1,906	

#### 2. Base

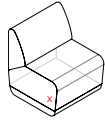
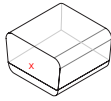
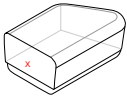
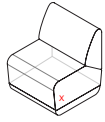
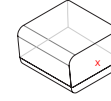
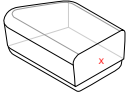
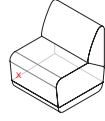
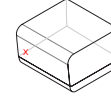

Base Finish	Code	Price
Graphite	LBC2	+ \$0
Slate	LBC3	+ \$0

## MODULAR LOUNGE SEATING

### 3. Power

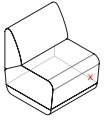
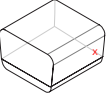
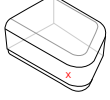
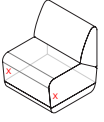
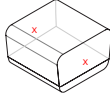
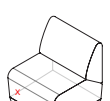
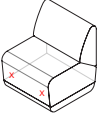
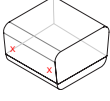

Power Location	Code	Price	
<b>Right-Hand, Side of Unit</b>			
AC/110V	PSR	+ \$125	
Dual USB	PSR	+ \$175	
AC/110V and Dual USB	PSR	+ \$300	
<b>Left-Hand, Side of Unit</b>			
AC/110V	PSL	+ \$125	
Dual USB	PSL	+ \$175	
AC/110V and Dual USB	PSL	+ \$300	
<b>Right-Hand, Front of Unit</b>			
AC/110V	PFR	+ \$125	
Dual USB	PFR	+ \$175	
AC/110V and Dual USB	PFR	+ \$300	

### 3. Power (Cont.)



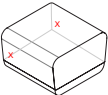
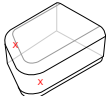
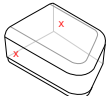
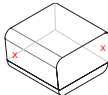
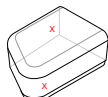
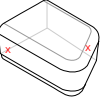
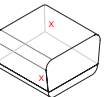
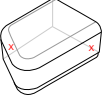

Power Location	Code	Price	
<b>Left-Hand, Front of Unit</b>			
AC/110V	PFL	+ \$125	
Dual USB	PFL	+ \$175	
AC/110V and Dual USB	PFL	+ \$300	
<b>Both Hands, Side of Unit</b>			
AC/110V	PSB	+ \$250	
Dual USB	PSB	+ \$350	
AC/110V and Dual USB	PSB	+ \$600	
<b>Both Hands, Front of Unit</b>			
AC/110V	PFB	+ \$250	
Dual USB	PFB	+ \$350	
AC/110V and Dual USB	PFB	+ \$600	

## MODULAR LOUNGE SEATING

### 3. Power (Cont.)

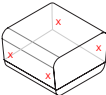
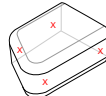
Power Location	Code	Price	
<b>One-Hand, 1 Front and 1 Back</b>			
AC/110V	PBRL	+ \$250	
Dual USB	PBRL	+ \$350	
AC/110V and Dual USB	PBRL	+ \$600	
<b>Both Hands (Right), 1 Front and 1 Back</b>			
AC/110V	PBR	+ \$250	
Dual USB	PBR	+ \$350	
AC/110V and Dual USB	PBR	+ \$600	
<b>Both Hands (Left), 1 Front and 1 Back</b>			
AC/110V	PBL	+ \$250	
Dual USB	PBL	+ \$350	
AC/110V and Dual USB	PBL	+ \$600	

### 3. Power (Cont.)

Power Location	Code	Price	
<b>Both Hands, 2 Front and Two Back</b>			
AC/110V	PBB	+ \$500	
Dual USB	PBB	+ \$700	
AC/110V and Dual USB	PBB	+ \$1,200	
Power Type	Code	Price	
AC/110V and Dual USB	PT2	Priced by Number of Units and Location	
Dual USB	PT3	Priced by Number of Units and Location	
AC/110V	PT4	Priced by Number of Units and Location	

Power is storm colored. Power not available on 120-Degree models (FS17 SS3, FS17 SS4, FS2 BNS6) or 90-degree models (FS17 SS5, FS2 BNS5).

### 4. Material

Protection: CAL 133	Code	Price	
<b>Fire Retardancy</b>			
Single Seat	UCAL	+ \$262	
1.5 Seat	UCAL	+ \$393	
90-Degree Corner Seat	UCAL	+ \$377	
120-Degree Seat	UCAL	+ \$377	
Single Bench	UCAL	+ \$88	
1.5 Bench	UCAL	+ \$175	
Angled Bench	UCAL	+ \$175	
90-Degree Bench	UCAL	+ \$175	
120-Degree Bench	UCAL	+ \$175	

Additional CAL 133 information can be found on page 10.

4. Material (Cont.)

Cleaning	Code	Price
<b>Moisture Barrier: Seat Only</b>		
Single Seat	UM2	+ \$59
1.5 Seat	UM2	+ \$89
90-Degree Corner Seat	UM2	+ \$118
120-Degree Corner Seat	UM2	+ \$118
Single Bench	UM2	+ \$59
1.5 Bench	UM2	+ \$118
Angled Bench	UM2	+ \$118
90-Degree Bench	UM2	+ \$177
120-Degree Bench	UM2	+ \$177
<b>Moisture Barrier: Back Only</b>		
Single Seat	UM1	+ \$59
1.5 Seat	UM1	+ \$89
90-Degree Corner Seat	UM1	+ \$118
120-Degree Corner Seat	UM1	+ \$118
<b>Moisture Barrier: Seat and Back</b>		
Single Seat	UM3	+ \$118
1.5 Seat	UM3	+ \$177
90-Degree Corner Seat	UM3	+ \$236
120-Degree Corner Seat	UM3	+ \$236
Fully Upholstered	Code	Price
<b>Single Seat</b>		
Fabric/Vinyl Grade 1	FG1/VG1	+ \$0
COM	COM	+ \$65
Fabric/Vinyl Grade 2	FG2/VG2	+ \$65
Fabric/Vinyl Grade 3	FG3/VG3	+ \$101
Fabric/Vinyl Grade 4	FG4/VG4	+ \$144
Fabric/Vinyl Grade 5	FG5/VG5	+ \$216
Fabric/Vinyl Grade 6	FG6/VG6	+ \$288
Fabric/Vinyl Grade 7	FG7/VG7	+ \$360

4. Material (Cont.)

Fully Upholstered	Code	Price
<b>1.5 Seat</b>		
Fabric/Vinyl Grade 1	FG1/VG1	+ \$0
COM	COM	+ \$86
Fabric/Vinyl Grade 2	FG2/VG2	+ \$86
Fabric/Vinyl Grade 3	FG3/VG3	+ \$134
Fabric/Vinyl Grade 4	FG4/VG4	+ \$192
Fabric/Vinyl Grade 5	FG5/VG5	+ \$288
Fabric/Vinyl Grade 6	FG6/VG6	+ \$384
Fabric/Vinyl Grade 7	FG7/VG7	+ \$480
<b>90-Degree Corner Seat</b>		
Fabric/Vinyl Grade 1	FG1/VG1	+ \$0
COM	COM	+ \$113
Fabric/Vinyl Grade 2	FG2/VG2	+ \$113
Fabric/Vinyl Grade 3	FG3/VG3	+ \$176
Fabric/Vinyl Grade 4	FG4/VG4	+ \$252
Fabric/Vinyl Grade 5	FG5/VG5	+ \$378
Fabric/Vinyl Grade 6	FG6/VG6	+ \$504
Fabric/Vinyl Grade 7	FG7/VG7	+ \$630
<b>120-Degree Seat</b>		
Fabric/Vinyl Grade 1	FG1/VG1	+ \$0
COM	COM	+ \$94
Fabric/Vinyl Grade 2	FG2/VG2	+ \$94
Fabric/Vinyl Grade 3	FG3/VG3	+ \$147
Fabric/Vinyl Grade 4	FG4/VG4	+ \$210
Fabric/Vinyl Grade 5	FG5/VG5	+ \$315
Fabric/Vinyl Grade 6	FG6/VG6	+ \$420
Fabric/Vinyl Grade 7	FG7/VG7	+ \$525
<b>Single Seat Bench</b>		
Fabric/Vinyl Grade 1	FG1/VG1	+ \$0
COM	COM	+ \$43
Fabric/Vinyl Grade 2	FG2/VG2	+ \$43
Fabric/Vinyl Grade 3	FG3/VG3	+ \$67
Fabric/Vinyl Grade 4	FG4/VG4	+ \$96
Fabric/Vinyl Grade 5	FG5/VG5	+ \$144
Fabric/Vinyl Grade 6	FG6/VG6	+ \$192
Fabric/Vinyl Grade 7	FG7/VG7	+ \$240

## MODULAR LOUNGE SEATING

### 4. Material (Cont.)

Fully Upholstered	Code	Price
<b>1.5 Seat Bench</b>		
Fabric/Vinyl Grade 1	FG1/VG1	+ \$0
COM	COM	+ \$54
Fabric/Vinyl Grade 2	FG2/VG2	+ \$54
Fabric/Vinyl Grade 3	FG3/VG3	+ \$84
Fabric/Vinyl Grade 4	FG4/VG4	+ \$120
Fabric/Vinyl Grade 5	FG5/VG5	+ \$180
Fabric/Vinyl Grade 6	FG6/VG6	+ \$240
Fabric/Vinyl Grade 7	FG7/VG7	+ \$300
<b>90-Degree Corner Bench</b>		
Fabric/Vinyl Grade 1	FG1/VG1	+ \$0
COM	COM	+ \$54
Fabric/Vinyl Grade 2	FG2/VG2	+ \$54
Fabric/Vinyl Grade 3	FG3/VG3	+ \$84
Fabric/Vinyl Grade 4	FG4/VG4	+ \$120
Fabric/Vinyl Grade 5	FG5/VG5	+ \$180
Fabric/Vinyl Grade 6	FG6/VG6	+ \$240
Fabric/Vinyl Grade 7	FG7/VG7	+ \$300
<b>120-Degree Seat Bench</b>		
Fabric/Vinyl Grade 1	FG1/VG1	+ \$0
COM	COM	+ \$54
Fabric/Vinyl Grade 2	FG2/VG2	+ \$54
Fabric/Vinyl Grade 3	FG3/VG3	+ \$84
Fabric/Vinyl Grade 4	FG4/VG4	+ \$120
Fabric/Vinyl Grade 5	FG5/VG5	+ \$180
Fabric/Vinyl Grade 6	FG6/VG6	+ \$240
Fabric/Vinyl Grade 7	FG7/VG7	+ \$300
<b>Angled End Bench</b>		
Fabric/Vinyl Grade 1	FG1/VG1	+ \$0
COM	COM	+ \$54
Fabric/Vinyl Grade 2	FG2/VG2	+ \$54
Fabric/Vinyl Grade 3	FG3/VG3	+ \$84
Fabric/Vinyl Grade 4	FG4/VG4	+ \$120
Fabric/Vinyl Grade 5	FG5/VG5	+ \$180
Fabric/Vinyl Grade 6	FG6/VG6	+ \$240
Fabric/Vinyl Grade 7	FG7/VG7	+ \$300

### 4. Material (Cont.)

Multi-Upholstery	Code	Price
Multi-Upholstery Upcharge	UMU	+ \$75
<b>Single Seat</b>		<b>Seat Only</b> <b>Back Only</b>
Fabric/Vinyl Grade 1	FG1/VG1	+ \$0    + \$0
COM	COM	+ \$43    + \$34
Fabric/Vinyl Grade 2	FG2/VG2	+ \$43    + \$34
Fabric/Vinyl Grade 3	FG3/VG3	+ \$67    + \$52
Fabric/Vinyl Grade 4	FG4/VG4	+ \$96    + \$75
Fabric/Vinyl Grade 5	FG5/VG5	+ \$144    + \$112
Fabric/Vinyl Grade 6	FG6/VG6	+ \$192    + \$150
Fabric/Vinyl Grade 7	FG7/VG7	+ \$240    + \$187
<b>1.5 Seat</b>		<b>Seat Only</b> <b>Back Only</b>
Fabric/Vinyl Grade 1	FG1/VG1	+ \$0    + \$0
COM	COM	+ \$54    + \$38
Fabric/Vinyl Grade 2	FG2/VG2	+ \$54    + \$38
Fabric/Vinyl Grade 3	FG3/VG3	+ \$84    + \$59
Fabric/Vinyl Grade 4	FG4/VG4	+ \$120    + \$84
Fabric/Vinyl Grade 5	FG5/VG5	+ \$180    + \$126
Fabric/Vinyl Grade 6	FG6/VG6	+ \$240    + \$168
Fabric/Vinyl Grade 7	FG7/VG7	+ \$300    + \$210



120-Degree Inner Seat



## 4. Material (Cont.)

Multi-Upholstery	Code	Price	
<b>90-Degree Seat</b>		Seat Only	Back Only
Fabric/Vinyl Grade 1	FG1/VG1	+\$0	+\$0
COM	COM	+\$59	+\$65
Fabric/Vinyl Grade 2	FG2/VG2	+\$59	+\$65
Fabric/Vinyl Grade 3	FG3/VG3	+\$92	+\$101
Fabric/Vinyl Grade 4	FG4/VG4	+\$132	+\$144
Fabric/Vinyl Grade 5	FG5/VG5	+\$198	+\$216
Fabric/Vinyl Grade 6	FG6/VG6	+\$264	+\$288
Fabric/Vinyl Grade 7	FG7/VG7	+\$330	+\$360
<b>120-Degree Seat</b>		Seat Only	Back Only
Fabric/Vinyl Grade 1	FG1/VG1	+\$0	+\$0
COM	COM	+\$59	+\$54
Fabric/Vinyl Grade 2	FG2/VG2	+\$59	+\$54
Fabric/Vinyl Grade 3	FG3/VG3	+\$92	+\$84
Fabric/Vinyl Grade 4	FG4/VG4	+\$132	+\$120
Fabric/Vinyl Grade 5	FG5/VG5	+\$198	+\$180
Fabric/Vinyl Grade 6	FG6/VG6	+\$264	+\$240
Fabric/Vinyl Grade 7	FG7/VG7	+\$330	+\$300

If different fabrics are selected for the seat and back, add the multiple upholstery upcharge as well, even if the fabrics are the same grade.

Please reference the *Textile Reference Guide* for pricing on fabric over grade 7 and leather over grade 3. Additional CAL 133 information can be found on page 10.

## 5. Options

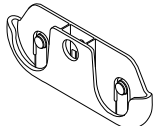
Accessories	Code	Price	
Two Ganging Brackets to Connect to Left-Side or Right-Side	XGV	+\$52	

One XGV set connects one side of a unit. Order two sets if you need the unit connected on both sides.

## 6. Packaging

Packaging	Code	Price	
Fully Assembled in Carton	P1	+\$0	

## MODULAR LOUNGE SEATING

### SINGLE SEAT AND BENCH SPECIFICATIONS

Model:	PAS FS17 SS1 Single Seat	PAS FS2 BNS1 Single Bench
<b>Dimensions</b>		
Height	31.5"	17.5"
Width	27"	27"
Depth	27"	27"
Seat Depth	17.9"	27"
Seat Height	17.5"	17.5"
Back Height	14.5"	N/A
<b>Materials</b>		
COM (Fully Upholstered)	3 yd	2 yd
COM (Multi-Upholstery)		
Seat Only	2 yd	N/A
Back Only	1.56 yd	
<b>Weight and Capacity</b>		
Weight	64.5 lb	49 lb
Weight Capacity Warranty	400 lb	400 lb

### 1.5 SEAT AND BENCH SPECIFICATIONS

Model:	PAS FS17 SS2 1.5 Seat	PAS FS2 BNS2 1.5 Bench
<b>Dimensions</b>		
Height	31.5"	17.5"
Width	36"	36"
Depth	27"	27"
Seat Depth	17.9"	27"
Seat Height	17.5"	17.5"
Back Height	14.5"	N/A
<b>Materials</b>		
COM (Fully Upholstered)	4 yd	2.5 yd
COM (Multi-Upholstery)		
Seat Only	2.5 yd	N/A
Back Only	1.75 yd	
<b>Weight and Capacity</b>		
Weight	82.5 lb	58.5 lb
Weight Capacity Warranty	800 lb	800 lb

## 90-DEGREE SEAT AND BENCH SPECIFICATIONS

Model:	PAS FS17 SS5 90-Degree Corner Seat	PAS FS2 BNS5 90-Degree Corner Bench
<b>Dimensions</b>		
Height	31.5"	17.5"
Width	30"	42.5"
Depth	30"	27"
Seat Depth	17.9"	27"
Seat Height	17.5"	17.5"
Back Height	14.5"	N/A
<b>Materials</b>		
COM (Fully Upholstered)	5.25 yd	2.5 yd
COM (Multi-Upholstery)		
Seat Only	2.75 yd	N/A
Back Only	3 yd	
<b>Weight and Capacity</b>		
Weight	86 lb	47 lb
Weight Capacity Warranty	400 lb	400 lb

## 120-DEGREE SEAT AND BENCH SPECIFICATIONS

Model:	PAS FS17 SS3 120-Degree Inner Seat	PAS FS17 SS4 120-Degree Outer Seat	PAS FS2 BNS6 120-Degree Bench
<b>Dimensions</b>			
Height	31.5"	31.5"	17.5"
Width	47.5"	47.5"	47.5"
Depth	27"	27"	27"
Seat Depth	17.9"	17.9"	27"
Seat Height	17.5"	17.5"	17.5"
Back Height	14.5"	14.5"	N/A
<b>Materials</b>			
COM (Fully Upholstered)	4.38 yd	4.38 yd	2.5 yd
COM (Multi-Upholstery)			
Seat Only	2.75 yd	2.75 yd	N/A
Back Only	2.5 yd	2.5 yd	
<b>Weight and Capacity</b>			
Weight	87.5 lb	78 lb	63 lb
Weight Capacity Warranty	800 lb	800 lb	800 lb

## MODULAR LOUNGE SEATING

### ANGLED BENCH SPECIFICATIONS

	PAS FS2 BNS3 Right-Angled	PAS FS2 BNS4 Left-Angled
<b>Dimensions</b>		
Height	17.5"	17.5"
Width	47.5"	47.5"
Depth	27"	27"
Seat Depth	27"	27"
Seat Height	17.5"	17.5"
<b>Materials</b>		
COM (Single Upholstery)	2.5 yd	2.5 yd
<b>Weight and Capacity</b>		
Weight	61.5 lb	61.5 lb
Weight Capacity Warranty	800 lb	800 lb



Single Seat Bench

# Paséa

## TABLES AND OTTOMANS

### *Lounge that works.*

Whether it's to rest your bag or your body, the modularity of the Paséa collection makes it easy to ensure there's always an extra place. This comprehensive collection includes a variety of ottomans and tables that pair perfectly with gapless seats and benches.



*Mini Round Ottoman*

*Large Square Ottoman*

**EFFECTIVE DECEMBER 1, 2021**

### Featured Models

#### **MINI ROUND OTTOMAN :: \$711**

Mini round ottoman, multi-upholstery, grade 1 textiles

#### **MINI ROUND OTTOMAN TABLE :: \$1,012**

Mini round ottoman, grade 4 textile, laminate tabletop



#### **LARGE SQUARE OTTOMAN :: \$1,431**

Large square ottoman, multi-upholstery, grade 4 seat textile grade 3 chassis textile

### Features

- Choose from an assortment of large and mini ottoman and table options, including square and round pieces
- Blend with any environment using graphite or slate base colors
- Tabletops come in five attractive laminate finishes
- Adjustable glides standard on large ottomans
- Fixed multi-surface glides standard on easy-to-move mini ottomans
- 400 lb weight capacity warranty (per seat)

#### 1. Product

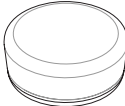
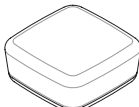
Model	Code	Price	
Mini Round Ottoman	PAS FS1 OS1	\$636	
Mini Square Ottoman	PAS FS1 OS3	\$636	
Large Round Ottoman	PAS FS1 OS2	\$1,218	
Large Square Ottoman	PAS FS1 OS4	\$1,218	

#### 2. Base

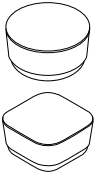
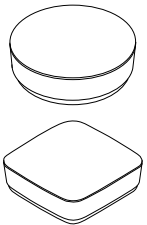

Base Finish	Code	Price
Graphite	LBC2	+ \$0
Slate	LBC3	+ \$0

#### 3. Tabletop

Tabletop Material	Code	Price	
No Tabletop	TM0	+ \$0	
Mini Round or Square Laminate Top	TM3	+ \$328	
Large Round or Square Laminate Top	TM3	+ \$722	

Tabletop Finish	Code	Price
Field Elm	TL13	+ \$0
Uptown Walnut	TL14	+ \$0
Skyline Walnut	TL15	+ \$0
Frosty White	TL16	+ \$0
Classic Linen	TL17	+ \$0

#### 4. Power

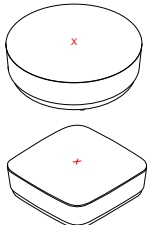
Power Type	Code	Price	
AC/110V and Dual USB	PT2	+ \$300	
Dual USB	PT3	+ \$175	
AC/110V	PT4	+ \$125	
Power Location	Code	Price	
Top Center	PTCC	Priced by Power Type	

Power is only available on large ottomans with tabletops. Power is located in the center of the laminate top.

TABLES AND OTTOMANS

5. Material

Protection	Code	Price	
Fire Retardancy		Mini Ottoman	Large Ottoman
CAL 133	UCAL	+ \$88	+ \$262
Cleaning	Code	Price	
Moisture Barrier		Mini Ottoman	Large Ottoman
Seat Only	UM2	+ \$35	+ \$177
Fully Upholstered	Code	Price	
Round		Mini Ottoman	Large Ottoman
Fabric/Vinyl Grade 1	FG1/VG1	+ \$0	+ \$0
COM	COM	+ \$38	+ \$72
Fabric/Vinyl Grade 2	FG2/VG2	+ \$38	+ \$72
Fabric/Vinyl Grade 3	FG3/VG3	+ \$59	+ \$112
Fabric/Vinyl Grade 4	FG4/VG4	+ \$84	+ \$161
Fabric/Vinyl Grade 5	FG5/VG5	+ \$126	+ \$241
Fabric/Vinyl Grade 6	FG6/VG6	+ \$168	+ \$322
Fabric/Vinyl Grade 7	FG7/VG7	+ \$210	+ \$402
Square		Mini Ottoman	Large Ottoman
Fabric/Vinyl Grade 1	FG1/VG1	+ \$0	+ \$0
COM	COM	+ \$40	+ \$74
Fabric/Vinyl Grade 2	FG2/VG2	+ \$40	+ \$74
Fabric/Vinyl Grade 3	FG3/VG3	+ \$63	+ \$115
Fabric/Vinyl Grade 4	FG4/VG4	+ \$90	+ \$165
Fabric/Vinyl Grade 5	FG5/VG5	+ \$135	+ \$247
Fabric/Vinyl Grade 6	FG6/VG6	+ \$180	+ \$330
Fabric/Vinyl Grade 7	FG7/VG7	+ \$225	+ \$412
Round or Square With Tabletop		Mini Ottoman	Large Ottoman
Fabric/Vinyl Grade 1	FG1/VG1	+ \$0	+ \$0
COM	COM	+ \$22	+ \$40
Fabric/Vinyl Grade 2	FG2/VG2	+ \$22	+ \$40
Fabric/Vinyl Grade 3	FG3/VG3	+ \$34	+ \$63
Fabric/Vinyl Grade 4	FG4/VG4	+ \$48	+ \$90
Fabric/Vinyl Grade 5	FG5/VG5	+ \$72	+ \$135
Fabric/Vinyl Grade 6	FG6/VG6	+ \$96	+ \$180
Fabric/Vinyl Grade 7	FG7/VG7	+ \$120	+ \$225

Cleaning and protection options are not applicable on ottomans with laminate tops.

5. Material (Cont.)

Multi-Upholstery	Code	Price	
Multi-Upholstery Upcharge	UMU	+ \$75	
Mini Round or Square Ottoman		Seat	Chassis
Fabric/Vinyl Grade 1	FG1/VG1	+ \$0	+ \$0
COM	COM	+ \$22	+ \$22
Fabric/Vinyl Grade 2	FG2/VG2	+ \$22	+ \$22
Fabric/Vinyl Grade 3	FG3/VG3	+ \$34	+ \$34
Fabric/Vinyl Grade 4	FG4/VG4	+ \$48	+ \$48
Fabric/Vinyl Grade 5	FG5/VG5	+ \$72	+ \$72
Fabric/Vinyl Grade 6	FG6/VG6	+ \$96	+ \$96
Fabric/Vinyl Grade 7	FG7/VG7	+ \$120	+ \$120
Large Round or Square Ottoman		Seat	Chassis
Fabric/Vinyl Grade 1	FG1/VG1	+ \$0	+ \$0
COM	COM	+ \$34	+ \$40
Fabric/Vinyl Grade 2	FG2/VG2	+ \$34	+ \$40
Fabric/Vinyl Grade 3	FG3/VG3	+ \$52	+ \$63
Fabric/Vinyl Grade 4	FG4/VG4	+ \$75	+ \$90
Fabric/Vinyl Grade 5	FG5/VG5	+ \$112	+ \$135
Fabric/Vinyl Grade 6	FG6/VG6	+ \$150	+ \$180
Fabric/Vinyl Grade 7	FG7/VG7	+ \$187	+ \$225

Ottomans with tabletops are only available fully upholstered.

If different fabrics are selected for the seat and chassis, add the multi-upholstery upcharge as well, even if the fabrics are the same grade

Please reference the Textile Reference Guide for pricing on fabric over grade 7. Additional CAL 133 information can be found on page 10.

6. Packaging

Packaging	Code	Price
Fully Assembled in Carton	P1	+ \$0

**SPECIFICATIONS: MINI OTTOMAN**

Model:	PAS FS1 OS1 Mini Round Ottoman	PAS FS1 OS3 Mini Square Ottoman
<b>Dimensions</b>		
Height	17.5"	17.5"
Width	24"	24"
Depth	24"	24"
Seat Depth	24"	24"
Seat Height	17.5"	17.5"
<b>Materials</b>		
COM (Fully Upholstered)	1.75 lb	1.88 yd
COM (Multi-Upholstery)		
Seat Top Only	1 yd	1 yd
Chassis Only	1 yd	1 yd
<b>Weight and Capacity</b>		
Weight	34 lb	43.5 lb
Weight Capacity Warranty	400 lb	400 lb

**SPECIFICATIONS: LARGE OTTOMAN**

Model:	PAS FS1 OS2 Large Round Ottoman	PAS FS1 OS4 Large Square Ottoman
<b>Dimensions</b>		
Height	17.5"	17.5"
Width	40"	40"
Depth	40"	40"
Seat Depth	40"	40"
Seat Height	17.5"	17.5"
<b>Materials</b>		
COM (Fully Upholstered)	3.35 yd	3.44 yd
COM (Multi-Upholstery)		
Seat Top Only	1.56 yd	1.56 yd
Chassis Only	1.88 yd	1.88 yd
<b>Weight and Capacity</b>		
Weight	74.5 lb	89.5 lb
Weight Capacity Warranty	800 lb	800 lb

**TABLES AND OTTOMANS**

**SPECIFICATIONS: MINI OTTOMAN TABLES**

Model:	FS1 OS1 Mini Round Table	FS1 OS3 Mini Square Table
<b>Dimensions</b>		
Height	13"	13"
Width	24"	24"
Depth	24"	24"
<b>Materials</b>		
COM	1.25 yd	1.25 yd
<b>Weight and Capacity</b>		
Weight	37 lb	37 lb
Weight Capacity Warranty	400 lb	400 lb

**SPECIFICATIONS: LARGE OTTOMAN TABLES**

Model:	FS1 OS2 Large Round Table	FS1 OS4 Large Square Table
<b>Dimensions</b>		
Height	13.3"	13.3"
Width	40"	40"
Depth	40"	40"
<b>Materials</b>		
COM	2 yd	2 yd
<b>Weight and Capacity</b>		
Weight	85 lb	85 lb
Weight Capacity Warranty	800 lb	800 lb

# Paséa

## INLINE TABLES

### *Lounge that works.*

Whether it's to rest your bag or your body, the modularity of the Paséa collection makes it easy to ensure there's always an extra place. This comprehensive collection includes a variety of inline tables that pair perfectly with gapless seats and benches.

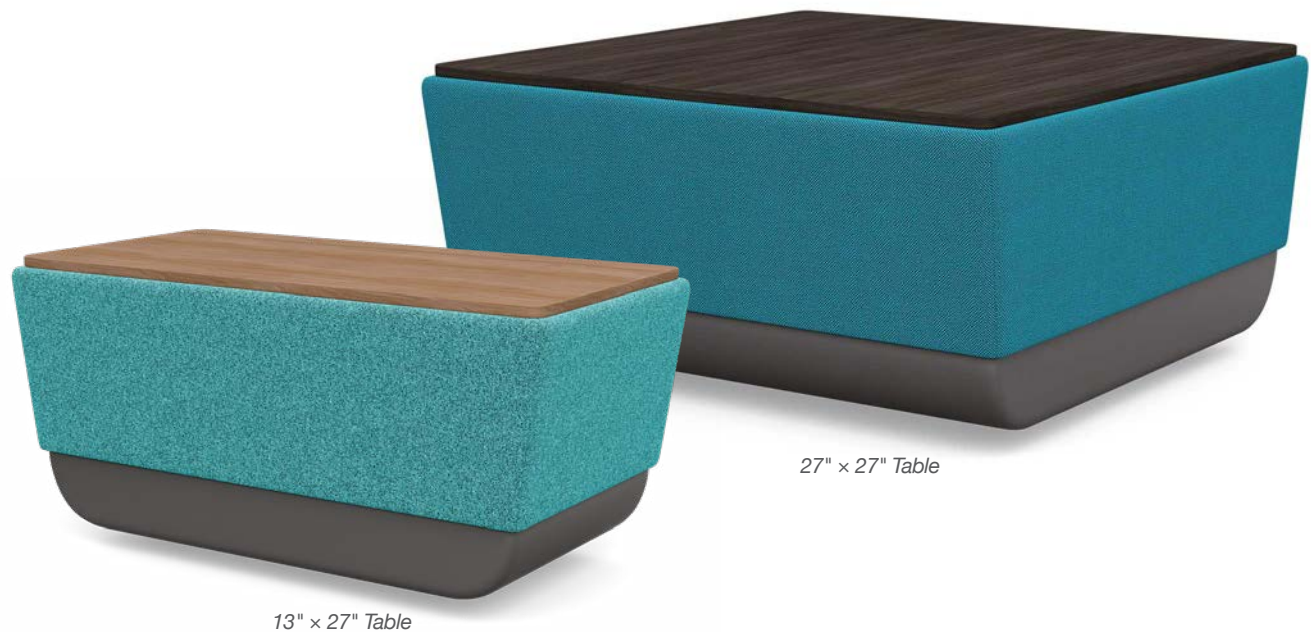

**EFFECTIVE DECEMBER 1, 2021**

### Featured Models

**13" x 27" :: \$996**

13" x 27" table, laminate top,  
grade 1 textile

**27" x 27" :: \$1,334**

27" x 27" table, laminate top,  
grade 1 textile

**90° CORNER :: \$2,065**

90-degree corner table, laminate top,  
grade 1 textile

## Features

- Choose from an assortment of large and mini ottoman  
Designed by Q Design
- Part of a comprehensive collection that also includes  
seats, benches and ottomans
- Provide extra convenience with available AC and USB  
power options
- Three tables that are designed to be used inline with  
Paséa seats and benches: the 13" x 27" table, 27" x 27"  
table and the 90-degree corner table
- Adjustable glides standard on all Paséa tables (except  
mini ottoman tables).
- Blend with any environment using graphite or slate  
base colors
- Tabletops come in five attractive laminate finishes

### 1. Product

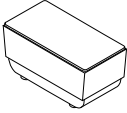
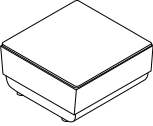
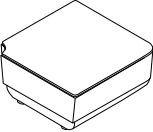
Model	Code	Price	
13" x 27" Table	FS18 BNS7	\$996	
27" x 27" Table	FS18 BNS1	\$1,334	
90-Degree Corner Table	FS18 BNS5	\$2,065	

### 2. Table Base

Base Finish	Code	Price
Graphite	LBC2	+ \$0
Slate	LBC3	+ \$0



## INLINE TABLES

### 3. Tabletop

Top Material	Code	Price
Laminate	TM3	+ \$0

Laminate Finish	Code	Price
Field Elm	TL13	+ \$0
Uptown Walnut	TL14	+ \$0
Skyline Walnut	TL15	+ \$0
Frosty White	TL16	+ \$0
Classic Linen	TL17	+ \$0

### 4. Power

Power Type	Code	Price	
AC/110V and Dual USB	PT2	+ \$300	
Dual USB	PT3	+ \$175	
AC/110V	PT4	+ \$125	

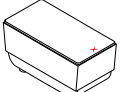
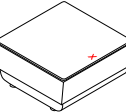
Power Location	Code	Price	
Top Rear	PTRC	Priced by Power Type	
Top Center	PTCC	Priced by Power Type	

13" x 27" (FS18 BNS7) and 27" x 27" (FS18 BNS1) tables are available with top rear power only. 90-degree corner table (FS18 BNS5) is available with top center power only.



INLINE TABLES

5. Material

Fully Upholstered	Code	Price
<b>13" x 27" Table</b>		
Fabric/Vinyl Grade 1	FG1/VG1	+ \$0
COM	COM	+ \$27
Fabric/Vinyl Grade 2	FG2/VG2	+ \$27
Fabric/Vinyl Grade 3	FG3/VG3	+ \$42
Fabric/Vinyl Grade 4	FG4/VG4	+ \$60
Fabric/Vinyl Grade 5	FG5/VG5	+ \$90
Fabric/Vinyl Grade 6	FG6/VG6	+ \$120
Fabric/Vinyl Grade 7	FG7/VG7	+ \$150
<b>27" x 27" Table</b>		
Fabric/Vinyl Grade 1	FG1/VG1	+ \$0
COM	COM	+ \$40
Fabric/Vinyl Grade 2	FG2/VG2	+ \$40
Fabric/Vinyl Grade 3	FG3/VG3	+ \$63
Fabric/Vinyl Grade 4	FG4/VG4	+ \$90
Fabric/Vinyl Grade 5	FG5/VG5	+ \$135
Fabric/Vinyl Grade 6	FG6/VG6	+ \$180
Fabric/Vinyl Grade 7	FG7/VG7	+ \$225
<b>90-Degree Corner Table</b>		
Fabric/Vinyl Grade 1	FG1/VG1	+ \$0
COM	COM	+ \$40
Fabric/Vinyl Grade 2	FG2/VG2	+ \$40
Fabric/Vinyl Grade 3	FG3/VG3	+ \$63
Fabric/Vinyl Grade 4	FG4/VG4	+ \$90
Fabric/Vinyl Grade 5	FG5/VG5	+ \$135
Fabric/Vinyl Grade 6	FG6/VG6	+ \$180
Fabric/Vinyl Grade 7	FG7/VG7	+ \$225

Please reference the Textile Reference Guide for pricing on fabric over grade 7. Additional CAL 133 information can be found on page 10.

6. Packaging

Packaging	Code	Price
Fully Assembled in Carton	P1	+ \$0

SPECIFICATIONS

Model:	FS18 BNS7 13" x 27" Table	FS18 BNS1 27" x 27" Table	FS18 BNS5 90-Degree Corner Table
<b>Dimensions</b>			
Height	13.3"	13.3"	13.3"
Width	13.4"	27"	30"
Depth	27"	27"	30"
<b>Materials</b>			
COM	1.25 yd	1.5 yd	1.5 yd
<b>Weight and Capacity</b>			
Weight	35 lb	64 lb	64 lb
Weight Capacity Warranty	400 lb	400 lb	400 lb

# Visit Modular

## LOUNGE SEATING

### *Sit. Stay awhile.*

With contemporary aesthetics, the Visit Modular collection features flexible modularity and arm options for inventive space planning. Link arm and armless models with ganging brackets and an ottoman for common areas and waiting rooms. Handy seat-back handles and functional tablet arms make Visit Modular perfect for collaborative spaces and pull-up meetings.

Our customizable lounge line is now even more convenient thanks to our new power modules. Crafted with minimal seams for smoother integration and a cleaner look, they can be installed on either the fronts or sides of our models.



*Armless Club Chair*

**EFFECTIVE DECEMBER 1, 2021**

## Featured Models

### **ARMLESS CLUB CHAIR :: \$1,589**

Club chair, armless, black plastic feet, multi-upholstery, grade 2 vinyl

### **UPHOLSTERED ARM CLUB CHAIR :: \$1,910**

Club chair, two upholstered arms, brushed aluminum pole feet, fully upholstered, grade 3 textile

### **WOOD ARM CLUB CHAIR :: \$2,015**

Club chair, two wood arms, square wood tapered feet, fully upholstered, grade 2 textile

### Features

- Armless chair and ottoman for modular seating
- Ganging brackets
- Two arm styles: armless, upholstered or wood
- Optional tablet arm
- Back hook or handle
- Optional power module available
- 300 lb weight capacity warranty



Wood Arm Club Chair

### 1. Product

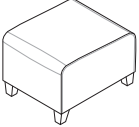
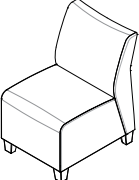
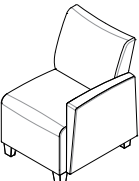
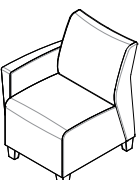
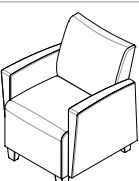
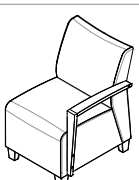
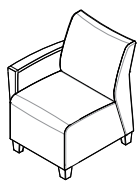
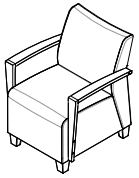
Model and Arm Style	Code	Price	
Ottoman	VS FS1	\$824	
Club Chair, Armless	VS	\$1,440	
Club Chair With Upholstered Left Arm	VS FS12	\$1,540	
Club Chair With Upholstered Right Arm	VS FS10	\$1,540	
Club Chair With Upholstered Left and Right Arms	VS FS8	\$1,640	
Club Chair With Wood Left Arm	VS FS11	\$1,640	
Club Chair With Wood Right Arm	VS FS9	\$1,640	
Club Chair With Wood Left and Right Arms	VS FS7	\$1,840	

Left and right arms are designated from the seated position.

# VISIT MODULAR

EFFECTIVE DECEMBER 1, 2021 | GSA SIN #: 33721

## 2. Back

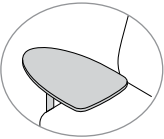
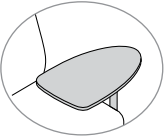
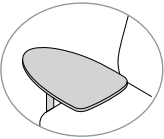
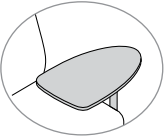

Back Options	Code	Price	
Hook/Handle (Not Available on Ottoman)	BX1	+ \$147	

## 3. Arm

Tablet Arm	Code	Price	
Tablet Arm, Right, Black Pole	AX3	+ \$342	
Tablet Arm, Right, Silver Pole	AX2	+ \$342	
Tablet Arm, Left, Black Pole	AX6	+ \$342	
Tablet Arm, Left, Silver Pole	AX5	+ \$342	



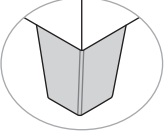
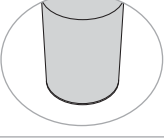
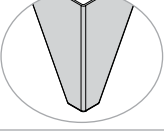
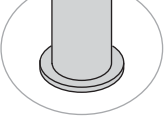

Tablet arms are available on the left or right side if the chair is configured as armless.

## 4. Foot

Front Foot Style and Color	Code	Price	
<b>Feet</b>			
Standard Plastic, Black	LS1	+ \$0	
Wood Tapered Square	LS12	+ \$70	
Wood Tapered Cylinder	LS11	+ \$70	
Metal Angular, Brushed Aluminum	LS6	+ \$60	
Metal 1.5" Pole, Brushed Aluminum	LS7	+ \$60	
Metal 1.5" Pole, Silver Powder Coat	LS8	+ \$60	

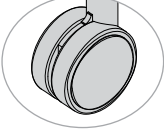
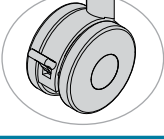
## CLUB CHAIR AND OTTOMAN

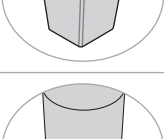
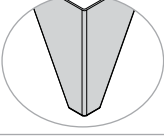
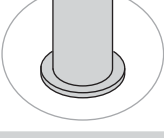
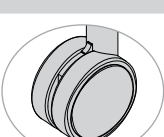
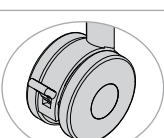
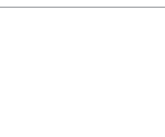
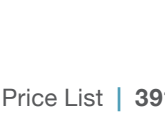
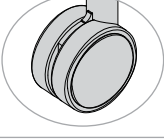
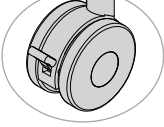
## 4. Foot (Cont.)

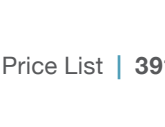
Front Foot Style and Color	Code	Price	
<b>Casters</b>			
Non-Locking Caster, Black	LS2	+ \$50	
Non-Locking Caster, Silver	LS3	+ \$50	
Locking Caster, Black	LS4	+ \$60	
Locking Caster, Silver	LS5	+ \$60	
<b>Back Foot Style and Color</b>			
<b>Feet</b>			
Standard Plastic, Black	LS1	+ \$0	
Wood Tapered Square	LS12	+ \$70	
Wood Tapered Cylinder	LS11	+ \$70	
Metal Angular, Brushed Aluminum	LS6	+ \$60	
Metal 1.5" Pole, Brushed Aluminum	LS7	+ \$60	
Metal 1.5" Pole, Silver Powder Coat	LS8	+ \$60	
<b>Casters</b>			
Non-Locking Caster, Black	LS2	+ \$50	
Non-Locking Caster, Silver	LS3	+ \$50	
Locking Caster, Black	LS4	+ \$60	
Locking Caster, Silver	LS5	+ \$60	

# VISIT MODULAR

EFFECTIVE DECEMBER 1, 2021 | GSA SIN #: 33721

## 5. Frame (For Wooden Feet L11/L12)

Frame Finish Color	Code	Price
Clear Maple	FCW1	+ \$0
Medium Cherry	FCW2	+ \$0
Amber Mahogany	FCW3	+ \$0
Espresso	FCW4	+ \$0
Stain-to-Match	STM	+ \$70
New Custom Stain	STL	+ \$275

*New Custom Stain (STL): If stain is not in our library, add this one-time fee in addition to the stain-to-match (STM) cost.*



Upholstered Arm Club Chair

## CLUB CHAIR AND OTTOMAN

## 6. Power

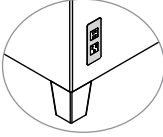
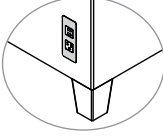
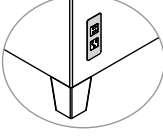
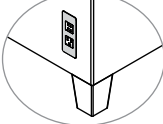
Location	Code	Price	
Right Hand, Front of Chair	PFR	+ \$250	
Left Hand, Front of Chair	PFL	+ \$250	
Right Hand, Side of Chair (Only Available on Armless Model)	PSR	+ \$250	
Left Hand, Side of Chair (Only Available on Armless Model)	PSL	+ \$250	

Color	Code	Price
Silver	PC2	+ \$0
Black	PC1	+ \$0

*Power only available on the side of chairs.*

*Each chair can only have power specified in one of the location options. Power cannot be specified on the same side of a chair where a tablet arm or magazine rack is specified.*

## 7. Material

Protection		Price			
Fire Retardancy		Club: 2 Upholstered Arms	Club: 1 Upholstered Arm	Club: Armless or Wood Arms	Ottoman
CAL 133	UCAL	+ \$262	+ \$262	+ \$262	+ \$262
Cleaning		Price			
Moisture Barrier		Club: 2 Upholstered Arms	Club: 1 Upholstered Arm	Club: Armless or Wood Arms	Ottoman
Seat Only	UM2	+ \$59	+ \$59	+ \$59	+ \$59
Back Only	UM1	+ \$59	+ \$59	+ \$59	+ \$59
Seat and Back	UM3	+ \$118	+ \$118	+ \$118	+ \$118
Upholstery		Price			
Fully Upholstered		Club: 2 Upholstered Arms	Club: 1 Upholstered Arm	Club: Armless or Wood Arms	Ottoman
Fabric/Vinyl Grade 1	FG1/VG1	+ \$0	+ \$0	+ \$0	+ \$0
COM	COM	+ \$50	+ \$39	+ \$35	+ \$23
Fabric/Vinyl Grade 2	FG2/VG2	+ \$50	+ \$39	+ \$35	+ \$23
Fabric/Vinyl Grade 3	FG3/VG3	+ \$150	+ \$119	+ \$105	+ \$68
Fabric/Vinyl Grade 4	FG4/VG4	+ \$250	+ \$198	+ \$175	+ \$113
Fabric/Vinyl Grade 5	FG5/VG5	+ \$375	+ \$298	+ \$263	+ \$169
Fabric/Vinyl Grade 6	FG6/VG6	+ \$550	+ \$439	+ \$385	+ \$248
Fabric/Vinyl Grade 7	FG7/VG7	+ \$775	+ \$616	+ \$543	+ \$349
Leather Grade 1	LG1	+ \$800	+ \$636	+ \$556	+ \$363
COL	COL	+ \$1,050	+ \$834	+ \$730	+ \$476
Leather Grade 2	LG2	+ \$1,050	+ \$834	+ \$730	+ \$476
Leather Grade 3	LG3	+ \$1,450	+ \$1,152	+ \$1,008	+ \$657
Multi-Upholstery		Price			
Multi-Upholstery	UMU	+ \$113			
Seat or Top and Front Textile Only		Club: 2 Upholstered Arms (Seat Textile)	Club: 1 Upholstered Arm (Seat Textile)	Club: Armless or Wood Arms (Seat Textile)	Ottoman (Top and Front Textile)
Fabric/Vinyl Grade 1	FG1/VG1	+ \$0	+ \$0	+ \$0	+ \$0
COM	COM	+ \$15	+ \$15	+ \$18	+ \$12
Fabric/Vinyl Grade 2	FG2/VG2	+ \$15	+ \$15	+ \$18	+ \$12
Fabric/Vinyl Grade 3	FG3/VG3	+ \$45	+ \$45	+ \$53	+ \$34
Fabric/Vinyl Grade 4	FG4/VG4	+ \$74	+ \$74	+ \$88	+ \$57
Fabric/Vinyl Grade 5	FG5/VG5	+ \$111	+ \$111	+ \$132	+ \$85
Fabric/Vinyl Grade 6	FG6/VG6	+ \$163	+ \$163	+ \$193	+ \$124
Fabric/Vinyl Grade 7	FG7/VG7	+ \$229	+ \$229	+ \$272	+ \$175
Leather Grade 1	LG1	+ \$237	+ \$237	+ \$278	+ \$182
COL	COL	+ \$310	+ \$310	+ \$365	+ \$238
Leather Grade 2	LG2	+ \$310	+ \$310	+ \$365	+ \$238
Leather Grade 3	LG3	+ \$428	+ \$428	+ \$504	+ \$329

If different fabrics are selected for the seat and back, add the multiple upholstery upcharge as well, even if the fabrics are the same grade

Please reference the Textile Reference Guide for pricing on fabric over grade 7 and leather over grade 3. Additional CAL 133 information can be found on page 10.

## 7. Material (Cont.)

Multi-Upholstery	Code	Price			
Back or Side Textile Only		Club: 2 Upholstered Arms (Back Textile)	Club: 1 Upholstered Arm (Back Textile)	Club: Armless or Wood Arms (Back Textile)	Ottoman (Side Textile)
Fabric/Vinyl Grade 1	FG1/VG1	+\$0	+\$0	+\$0	+\$0
COM	COM	+\$15	+\$15	+\$18	+\$12
Fabric/Vinyl Grade 2	FG2/VG2	+\$15	+\$15	+\$18	+\$12
Fabric/Vinyl Grade 3	FG3/VG3	+\$45	+\$45	+\$53	+\$34
Fabric/Vinyl Grade 4	FG4/VG4	+\$74	+\$74	+\$88	+\$57
Fabric/Vinyl Grade 5	FG5/VG5	+\$111	+\$111	+\$132	+\$85
Fabric/Vinyl Grade 6	FG6/VG6	+\$163	+\$163	+\$193	+\$124
Fabric/Vinyl Grade 7	FG7/VG7	+\$229	+\$229	+\$272	+\$175
Leather Grade 1	LG1	+\$237	+\$237	+\$278	+\$182
COL	COL	+\$310	+\$310	+\$365	+\$238
Leather Grade 2	LG2	+\$310	+\$310	+\$365	+\$238
Leather Grade 3	LG3	+\$428	+\$428	+\$504	+\$329
Arm/Arms Textile Only		Club: 2 Upholstered Arms (Arms Only)	Club: 1 Upholstered Arm (Arm Only)		
Fabric/Vinyl Grade 1	FG1/VG1	+\$0	+\$0		
COM	COM	+\$21	+\$11		
Fabric/Vinyl Grade 2	FG2/VG2	+\$21	+\$11		
Fabric/Vinyl Grade 3	FG3/VG3	+\$62	+\$31		
Fabric/Vinyl Grade 4	FG4/VG4	+\$103	+\$52		
Fabric/Vinyl Grade 5	FG5/VG5	+\$154	+\$77		
Fabric/Vinyl Grade 6	FG6/VG6	+\$226	+\$113		
Fabric/Vinyl Grade 7	FG7/VG7	+\$318	+\$159		
Leather Grade 1	LG1	+\$328	+\$164		
COL	COL	+\$431	+\$216		
Leather Grade 2	LG2	+\$431	+\$216		
Leather Grade 3	LG3	+\$595	+\$298		

If different fabrics are selected for the seat and back, add the multiple upholstery upcharge as well, even if the fabrics are the same grade.

Please reference the Textile Reference Guide for pricing on fabric over grade 7 and leather over grade 3. Additional CAL 133 information can be found on page 10.

## 8. Options

Ganging Bracket	Code	Price
One Set of Ganging Brackets, Left-Attaching	XGVL	+\$52
One Set of Ganging Brackets, Right-Attaching	XGVR	+\$52
Two Sets of Ganging Brackets, One Set Left-Attaching and One Set Right-Attaching	XGV	+\$103

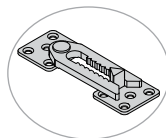

## SPECIFICATIONS

Model:	VS FS8 Club Chair With 2 Upholstered Arms	VS FS11 / VS FS12 Club Chair With 1 Upholstered Arm	VS Armless Club Chair	VS FS7 Club Chair With Wood Arm or Arms	VS S1 Ottoman
<b>Dimensions</b>					
Height	35"	35"	35"	35"	N/A
Width	28.5"	28.5"	22.5"	28.5"	N/A
Depth	29"	29"	29"	29"	N/A
Seat Width	22"	22"	22"	22"	22"
Seat Depth	21"	21"	21"	21"	21"
Seat Height	19.5"	19.5"	19.5"	20"	17.5"
Back Height	17"	17"	17"	17"	N/A
Arm Height	26.5"	26.5"	N/A	26.5"	N/A
<b>Materials</b>					
<b>COM</b>					
Fully Upholstered	5.4 yd	4.25 yd	3.5 yd	3.5 yd	1.88 yd
Seat Only	1.9 yd	1.9 yd	1.9 yd	1.9 yd	N/A
Back Only	2.2 yd	2.2 yd	2.2 yd	2.2 yd	N/A
Arms Only	2.9 yd	1.75 yd	2.9 yd	2.9 yd	N/A
Side Only	N/A	N/A	N/A	N/A	0.94 yd
Seat and Side Only	N/A	N/A	N/A	N/A	1.88 yd
<b>COL</b>					
Fully Upholstered	83.3 sq ft	72 sq ft	54.5 sq ft	54.5 sq ft	29.4 sq ft
Seat Only	29.4 sq ft	29.4 sq ft	29.4 sq ft	29.4 sq ft	N/A
Back Only	34.3 sq ft	34.3 sq ft	34.3 sq ft.	34.3 sq ft	N/A
Arms Only	44.1 sq ft	26 sq ft	44.1 sq ft	44.1 sq ft	N/A
Side Only	N/A	N/A	N/A	N/A	14.7 sq ft
Seat and Side Only	N/A	N/A	N/A	N/A	29.4 sq ft
<b>Weight and Capacity</b>					
Weight	48 lb	43 lb	38 lb	48 lb	28 lb
Weight Capacity Warranty (Per Seat)	300 lb	300 lb	300 lb	300 lb	300 lb

Yardage requirements for COM and COL are for solid and non-directional fabrics. Additional material may be required for larger repeating patterns.



# Tables and Desks

COFFEE TABLE | END TABLE  
HEIGHT-ADJUSTABLE TABLE  
MULTIPURPOSE TABLE  
DESK AND RETURN

# Mezzanine

CUBE END TABLE, COFFEE TABLE AND CORNER TABLE

## *Get in top shape.*

Mezzanine® tables are available in two popular styles—cube and occasional. From the modernist cube to the transitional occasional style, these accent pieces are designed to complement any SitOnIt Seating chair, settee or sofa. Built with the highest quality veneers and hardwoods, Mezzanine tables are designed to withstand the repeated use required of high traffic lobbies and waiting areas. Add a finishing touch to any space with tables as distinctive as your seating.



*Coffee Table*

**EFFECTIVE DECEMBER 1, 2021**

## Featured Models

### **END TABLE :: \$965**

End table, standard black plastic feet

### **COFFEE TABLE :: \$1,353**

Coffee table, wood tapered square feet

### **CORNER TABLE :: \$1,580**

Corner table, brushed aluminum pole feet

## CUBE END TABLE, COFFEE TABLE AND CORNER TABLE

### Features

- Armless chair and ottoman for modular seating
- Ganging brackets
- Two arm styles: armless, upholstered or wood

### 1. Product

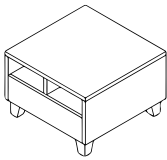
Table Type	Code	Price	
End Table	MCM TT1	\$965	
Coffee Table	MCM TT2	\$1,213	
Corner Table	MCM TT3	\$1,460	





End Table

### 2. Appearance

Table Finish Color	Code	Price
Clear Maple	FCW1	+ \$0
Medium Cherry	FCW2	+ \$0
Amber Mahogany	FCW3	+ \$0
Espresso	FCW4	+ \$0
Stain-to-Match	STM	+ \$70
New Custom Stain	STL	+ \$275

*New Custom Stain (STL): If stain is not in our library, add this one-time \$275 net fee in addition to the \$70 stain-to-match (STM) cost.*

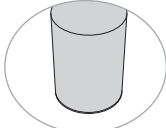
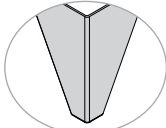
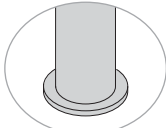
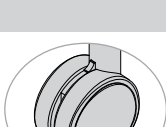
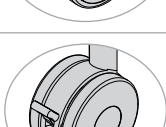
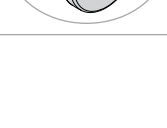
### 2. Feet

Foot Style and Color	Code	Price	
<b>Feet</b>			
Standard Plastic, Black	LS1	+ \$0	
Wood Tapered Square	LS12	+ \$140	
Wood Tapered Cylinder	LS11	+ \$140	
Metal Angular, Brushed Aluminum	LS6	+ \$120	
Metal 1.5" Pole, Brushed Aluminum	LS7	+ \$120	
Metal 1.5" Pole, Silver Powder Coat	LS8	+ \$120	
<b>Casters</b>			
Non-Locking Caster, Black	LS2	+ \$100	
Non-Locking Caster, Silver	LS3	+ \$100	
Locking Caster, Black	LS4	+ \$120	
Locking Caster, Silver	LS5	+ \$120	

### 3. Options

Ganging Brackets	Code	Price	
One Set, Left-Attaching	XGVL	+ \$52	
One Set, Right-Attaching	XGVR	+ \$52	
Two Sets, Left- and Right-Attaching	XGV	+ \$103	

### 4. Packaging

Packaging	Code	Price	
Knocked Down	P7	+ \$0	

### SPECIFICATIONS

Model:	MCM TT1 End Table	MCM TT2 Coffee Table	MCM TT3 Corner Table
Height	17"	17"	17"
Width	13.5"	25"	31.5"
Depth	25"	25"	31.5"
Weight	35 lb	52 lb	59 lb



Corner Table

# Mezzanine

## OCCASIONAL TABLE

### *Get in top shape.*

Mezzanine® tables are available in two popular styles—cube and occasional. From the modernist cube to the transitional occasional style, these accent pieces are designed to complement any chair, settee or sofa. Built with the highest quality veneers and hardwoods, Mezzanine tables are designed to withstand the repeated use required of high traffic lobbies and waiting areas. Add a finishing touch to any space with tables as distinctive as your seating.



*Square Occasional Table*

**EFFECTIVE DECEMBER 1, 2021**

### Featured Models

#### **SQUARE :: \$1,339**

Square occasional table, 21" tabletop, 24" high wood tapered square legs

#### **RECTANGULAR :: \$1,758**

Rectangular occasional table, 48" tabletop, 24" high wood tapered square legs



#### **OVAL :: \$1,858**

Oval occasional table, 48" tabletop, 18" high brushed aluminum pole legs

## Features

- Four occasional table shapes
- Three edge types
- Three leg styles
- Four wood stain finishes and stain-to-match program

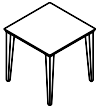
### 1. Product

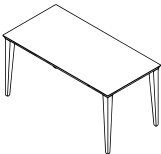
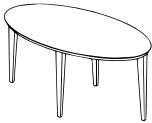
Table Type	Code	Price	
Square Occasional Table	MZM TT8	\$1,279	
Round Occasional Table	MZM TT6	\$1,279	
Rectangular Occasional Table	MZM TT5	\$1,698	
Oval Occasional Table	MZM TT4	\$1,698	

### 2. Size

Table Top Size	Code	Price	
<b>For Square and Round Tables</b>			
21"	TZ21	+ \$0	
24"	TZ24	+ \$99	
36"	TZ36	+ \$495	
<b>For Rectangular and Oval Tables</b>			
48"	TZ48	+ \$0	
Table Height	Code	Price	
16"	TH16	+ \$0	
18"	TH18	+ \$20	
21"	TH21	+ \$40	
24"	TH24	+ \$60	

## OCCASIONAL TABLES

### 3. Appearance

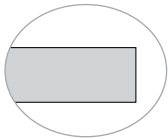
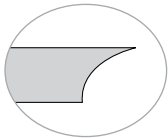
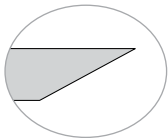
Table Top Edge Style	Code	Price	
Square	TE1	+ \$0	
Bevel	TE2	+ \$0	
Knife	TE3	+ \$0	

Finish Color	Code	Price	
Clear Maple	FCW1	+ \$0	
Medium Cherry	FCW2	+ \$0	
Amber Mahogany	FCW3	+ \$0	
Espresso	FCW4	+ \$0	
Stain-to-Match	STM	+ \$70	
New Custom Stain	STL	+ \$275	

*New Custom Stain (STL): If stain is not in our library, add this one-time \$275 net fee in addition to the \$70 stain-to-match (STM) cost.*

### 4. Legs

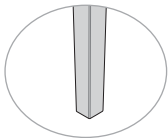
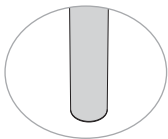
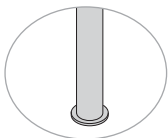
Leg Style	Code	Price	
Wood Tapered Square Leg	LSL2	+ \$0	
Wood Tapered Cylinder Leg	LSL3	+ \$0	
Metal 1.5" Pole, Brushed Aluminum Leg	LSL1	+ \$140	

### 5. Options

Protection	Code	Price
Protective Wood Guard Clear Tape	LX1	+ \$84

*Protective Wood Guard (LX1) is available on wood legs (LSL2/LSL3) only.*

### 4. Packaging

Packaging	Code	Price
Knocked Down	P7	+ \$0

### SPECIFICATIONS: SQUARE

Model:	MZM TT8 Square Table		
	21"	24"	36"
Width	21"	24"	36"
Depth	21"	24"	36"
Weight	30 lb	34 lb	57 lb

Model:	MZM TT6 Round Table		
	21"	24"	36"
Width	21"	24"	36"
Depth	21"	24"	36"
Weight	27 lb	30 lb	48 lb

Model:	MZM TT5 Rectangle Table	MZM TT4 Oval Table
Width	48"	48"
Depth	24"	24"
Weight	52 lb	52 lb

*Square, round, rectangular and oval tables are available in multiple heights.*



*Rectangular Occasional Table*

# Ocala

## FLIP-TOP TABLES

### *Mighty and mobile.*

The Ocala flip-top table is the simple yet sophisticated nesting table that solves all of your training and meeting room needs. Set-up takes just seconds—table surface flips and locks with the pull of a lever. The table nests for convenient, space-saving storage.



24" x 60"

*Chair sold separately; see page 247 for Movi.*

**EFFECTIVE DECEMBER 1, 2021**

### Featured Models

**24" x 60" :: \$805**

24" x 60" top, flip-top base, no grommets

**30" x 72" :: \$948**

30" x 72" top, flip-top base, no grommets



## Features

- Welded and bolted construction with steel end caps
- Multiple laminate options to fit your style
- Optional grommets for easy and clean setup of electronic devices
- Silver and white base finishes
- Casters are standard on all models
- 60", 66" and 72" top lengths
- 130 lb weight capacity warranty

## SPECIFICATIONS

	3061 TBT2 Ocala Flip-Top Table
Height	28.59"
Height With Top Flipped Up	41.11"
Base Length	58.99"
Foot Length:	21.9"
Base Top Support Length:	52.84"
Distance Between Legs:	50.15"
Weight Capacity Warranty	130 lb

Height includes 1.125" tabletop and casters.

### 1. Product

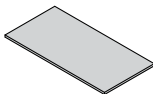
Product Type	Code	Price	
Rectangular Top	3061 TBT2	Priced by Size	

### 2. Size

Tabletop Size (D x W)	Code	Price
24" x 60"	TZ2460	\$287
24" x 66"	TZ2466	\$318
24" x 72"	TZ2472	\$345
30" x 60"	TZ3060	\$359
30" x 66"	TZ3066	\$395
30" x 72"	TZ3072	\$430

## TABLETOP

TOPS AND BASES ARE SPECIFIED AND SOLD SEPARATELY.

### 3. Tabletop Finish

Laminate Color	Code	Price
<b>Grade 1</b>		
Ankara Cherry	TL18	Priced by Grade
Black	TL19	Priced by Grade
Brazilian Walnut	TL20	Priced by Grade
Cabinet Maple	TL21	Priced by Grade
Driftwood	TL23	Priced by Grade
Folkstone Grey	TL24	Priced by Grade
Libretti	TL25	Priced by Grade
Queenston Oak	TL26	Priced by Grade
Sandalwood	TL27	Priced by Grade
Walnut Amati	TL28	Priced by Grade
White	TL29	Priced by Grade
Laminate Grade	Code	Price

### 4. Grommets

Grommet Location	Code	Price	
None	GP00	+ \$0	
Left	GP01	+ \$30	
Center	GP02	+ \$30	
Right	GP03	+ \$30	
Left and Center	GP04	+ \$60	
Left and Right	GP05	+ \$60	
Right and Center	GP06	+ \$60	
Left, Right and Center	GP07	+ \$90	
Grommet Color	Code	Price	
Black	GC01	+ \$0	
White	GC02	+ \$0	

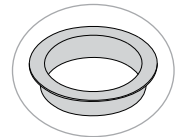

## 1. Product

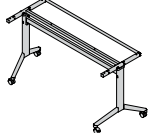
Product Type	Code	Price	
Flip-Top Base	3062 TBT2	\$518	

## 2. Size

Tabletop Size (D x W)	Code	Price
24" x 60"	TZ2460	+ \$0
24" x 66"	TZ2466	+ \$0
24" x 72"	TZ2472	+ \$0
30" x 60"	TZ3060	+ \$0
30" x 66"	TZ3066	+ \$0
30" x 72"	TZ3072	+ \$0

Bases require the specification of a tabletop size. Bases take their size from their corresponding tabletop.

## 3. Base Finish

Paint Color	Code	Price
Silver	BF01	+ \$0
White	BF02	+ \$0

## TABLE BASE

TOPS AND BASES ARE SPECIFIED AND SOLD SEPARATELY.

## 1. Additional Options (Sold Separately)

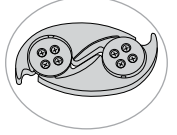
Product Type	Code	Price	
Pair of Ganging Brackets	3159 XGV	\$43	



# Parallon

## FLIP-TOP AND FIXED TOP TRAINING TABLE

### *Everything to the table.*

When you want cohesion in spaces large, small, shared or separate, there's Parallon. It's a single collection with a singular look, offering an array of choices for a variety of environments—and all the features to fit. Ensure design is never a distraction in the places where everyone needs to focus. Our Parallon line of training tables provides a unified and streamlined look from room to room.



30" x 72" Fixed Top  
Chairs sold separately.  
See page 247 for Movi.

**EFFECTIVE DECEMBER 1, 2021**

### Featured Models

**24" x 60" FIXED :: \$742**

24" x 60" tabletop, grade 1 laminate,  
fixed base, glides

**30" x 60" FLIP-TOP :: \$933**

30" x 60" tabletop, grade 1 laminate,  
flip-top base, casters

**30" x 72" FIXED :: \$985**

30" x 72" tabletop, grade 2 laminate,  
fixed base, glides

## Features

- A broad yet curated collection that's easy to specify across countless applications
- Developed entirely in-house (from the ground up) to make space cohesion effortless
- Training or collaboration—enjoy a variety of table types, tops, bases and more
- Soft-close flip-top models with quick-release latches can nest, store and deploy easily
- Powder-coated metal finishes in black, white or silver
- An array of 28 laminate options; 11 Grade 1 and 17 Grade 2
- 300 lb weight capacity warranty
- Exceeds BIFMA requirements for safety.

### 1. Product

Product Type	Code	Price	
Tabletop	3271	Priced by Size	
Table Base	Code	Price	
Flip-Top	TBT2	Priced by Size	
Fixed Top	TBT3	Priced by Size	

### 2. Size

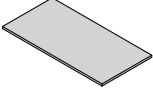
Tabletop Size	Code	Price	
24" x 48"	TZ2448	\$262	
24" x 60"	TZ2460	\$297	
24" x 72"	TZ2472	\$334	
30" x 48"	TZ3048	\$276	
30" x 60"	TZ3060	\$308	
30" x 72"	TZ3072	\$360	

### 3. Edge

Edge Profile	Code	Price	
Edgeband	TE5	+ \$0	

### 4. Tabletop Finish

Laminate Color	Code	Price
<b>Grade 1 Laminate</b>		
Ankara Cherry	TL18	Priced by Grade
Black	TL19	Priced by Grade
Brazilian Walnut	TL20	Priced by Grade
Cabinet Maple	TL21	Priced by Grade
Driftwood	TL23	Priced by Grade
Folkstone Grey	TL24	Priced by Grade
Libretti	TL25	Priced by Grade
Queenston Oak	TL26	Priced by Grade
Sandalwood	TL27	Priced by Grade
Walnut Amati	TL28	Priced by Grade
White	TL29	Priced by Grade
<b>Grade 2 Laminate</b>		
Classic Linen	TL17	Priced by Grade
Colombian Walnut	TL55	Priced by Grade
Crisp Linen	TL64	Priced by Grade
Designer White	TL66	Priced by Grade
Field Elm	TL13	Priced by Grade
Frosty White	TL16	Priced by Grade
Grey	TL62	Priced by Grade
Grey Elm	TL51	Priced by Grade
Kingswood Walnut	TL53	Priced by Grade
Manitoba	TL56	Priced by Grade
Neo Walnut	TL50	Priced by Grade
Platinum	TL61	Priced by Grade
Portico Teak	TL60	Priced by Grade
Skyline Walnut	TL15	Priced by Grade
Steel Mesh	TL59	Priced by Grade
Tuscan Walnut	TL57	Priced by Grade
Uptown Walnut	TL14	Priced by Grade

### 4. Tabletop Finish

Laminate Grade	Code	24" (D) Price	30" (D) Price
<b>48" Wide Tabletop</b>			
Grade 1 Laminate	GR1	+ \$0	+ \$0
Grade 2 Laminate	GR2	+ \$131	+ \$138
<b>60" Wide</b>			
Grade 1 Laminate	GR1	+ \$0	+ \$0
Grade 2 Laminate	GR2	+ \$149	+ \$154
<b>72" Wide</b>			
Grade 1 Laminate	GR1	+ \$0	+ \$0
Grade 2 Laminate	GR2	+ \$167	+ \$180

### 5. Grommets

Grommet Location	Code	Price	
No Grommets	GP00	+ \$0	
<b>Circular Grommets</b>			
Left Only	GP01	+ \$30	
Center Only	GP02	+ \$30	
Right Only	GP03	+ \$30	
Left & Center	GP04	+ \$60	
Left & Right	GP05	+ \$60	
Right & Center	GP06	+ \$60	
Left, Right & Center	GP07	+ \$90	
<b>Cutouts</b>			
Precut for Parallon Power Accessory	GP08	+ \$30	
Grommet Color	Code	Price	
Black	GC01	+ \$0	
White	GC02	+ \$0	

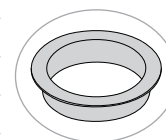

*Cutout option (GP08) is intended for use with a power unit. Corresponding grommet comes packaged with the power, which is sold separately. See page 410 to purchase Parallon power accessories.*

*Circular grommets cannot be paired with power options.*



24" x 60" Fixed Top  
Chair sold separately. See page 78 for Hexy.

### 1. Product

Product Type	Code	Price	
Table Base	3272	Priced by Base Style	
Base Style	Code	Price	

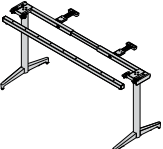
Flip-Top T	TBT2	\$625	
------------	------	-------	---

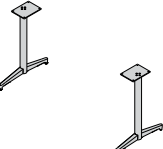
Fixed Top T	TBT3	\$445	
-------------	------	-------	---

### 2. Size

Tabletop Size	Code	Price	
24" x 48"	TZ2448	+ \$0	
24" x 60"	TZ2460	+ \$0	
24" x 72"	TZ2472	+ \$0	
30" x 48"	TZ3048	+ \$0	
30" x 60"	TZ3060	+ \$0	
30" x 72"	TZ3072	+ \$0	

Table bases require the specification of a tabletop size. Bases take their size from their corresponding top size.

### 3. Base Finish

Paint Color	Code	Price	
Silver	BF01	+ \$0	
White	BF02	+ \$0	
Black	BF03	+ \$0	

### 4. Feet

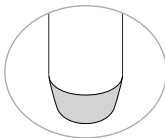
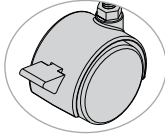
Foot Style	Code	Price	
Glides	LS18	+ \$0	
Casters	LS19	+ \$0	

Glide color will match base finish color.



30" x 60" Flip-Top (Flipped and Nested)

### Features

- Daisy chain power and cable management will put a charge into any area
- Corded, hardwired daisy chain kit options: 5A/120V AC power receptacles or 2.1A/5V dual USB charging ports
- UL/ETL listed for US and Canada
- Hardwire power (4-circuit) for more demanding applications: 8 wire 4 circuit (3+1) system, single-sided quad power blocks, 4-15A/120V AC simplex receptacles, 4 data knockouts for RJ45 connectors -
- ETL listed for US and Canada.

#### 1. Standalone Power Kit

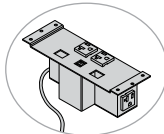
Product Type	Code	Price	
Standalone 3-Prong Infeed	3131 PV1 SA1	\$452	
Power Type	Code	Price	
2AC, Dual USB, 2 Data	PT8	+ \$0	
Power Color	Code	Price	
Silver	PC2	+ \$0	

#### 1. Daisy Chain Power

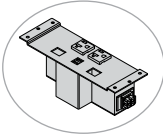
Daisy Chain Power Kit	Code	Price	
Single Quick Kit	3131 PV1 Q1	\$575	
Table Length	Code	Price	
48"	DL48	+ \$0	
60"	DL60	+ \$18	
72"	DL72	+ \$36	
Power Type	Code	Price	
2AC, Dual USB, 2 Data	PT8	+ \$0	
Power Color	Code	Price	
Silver	PC2	+ \$0	

#### 2. Daisy Chain Power Infeed

Product Type	Code	Price	
Power Infeed	3131 PV1 IF	Priced by Style	
Product Style	Code	Price	
Hardwire, 72"	HWC72	+ \$140	
3-Prong, 72"	TPC72	+ \$214	

Maximum of 9 tables per infeed.

## 1. Hardwire Power

Power Style	Code	Price	
4-Circuit, Single Sided, Power and Data Ready	3132 PS1 SB1 PT7	\$325	
Power Color	Code	Price	
Black	PC1	+ \$0	

## 2. Hardwire Power Linking Cables

Linking Cables	Code	Price	
8-Wire, 4-Circuit Interconnect Cables	3132 PS1 IC	Priced by Style	
Length (IC Only)	Code	Price	
42" for 48" Tabletops	IC42	+ \$0	
54" for 60" Tabletops	IC54	+ \$33	
66" for 72" Tabletops	IC66	+ \$66	

## 3. Hardwire Power Infeed

Product Style	Code	Price	
Hardwire Power Infeed, 72"	3132 PS1 IF HWC72	Priced by Length	

Maximum of 5 linked tables per circuit. Maximum of 20 linked tables if all 4 circuits are used.

## ACCESSORIES AND POWER PRODUCTS EACH SOLD SEPARATELY.

## 1. Wire Management

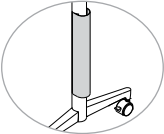
Product Type	Code	Price	
Leg Cover	3279 WM07	\$49	
Paint Color	Code	Price	
Silver	WMC01	\$0	
White	WMC02	\$0	
Black	WMC03	\$0	

## 1. Other Accessories

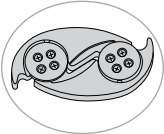
Ganging	Code	Price	
Pair of Ganging Brackets	3159 XGV	\$43	

Ganging brackets are not recommended on flip-top tables.



# Parallon

## CAFÉ AND OCCASIONAL TABLE

### *Everything to the table.*

When you want cohesion in spaces large, small, shared or separate, there's Parallon. It's a single collection with a singular look, offering an array of choices for a variety of environments—and all the features to fit. Continue the cohesion even when it's time to “take five” from meeting or training. Our café + occasional tables help carry the design into your casual and touch-down spaces.



*Café Table*  
Chairs sold separately. See page 194 for Baja.

**EFFECTIVE DECEMBER 1, 2021**

### Featured Models

**CAFÉ :: \$708**

30" square laminate tabletop,  
29" column height, grade 2 laminate

**BAR-HEIGHT :: \$785**

36" square laminate tabletop,  
42" column height, grade 2 laminate

**OCCASIONAL :: \$594**

24" round laminate tabletop,  
16" column height, grade 2 laminate

## Features

- A broad yet curated collection that's easy to specify across countless applications
- Developed entirely in-house (from the ground up) to make space cohesion effortless
- Café or occasional—enjoy a variety of table types, tops, bases and more
- Five column height choices
- Powder-coated metal finishes in black, white or silver
- An array of 28 laminate options; 11 Grade 1 and 17 Grade 2
- 300 lb weight capacity warranty
- Exceeds BIFMA requirements for safety.

### 1. Product

Product Type	Code	Price
Tabletop	3271	Priced by Size
Pairs With	Code	Price
X-Base Café/Occasional	TBT4	Priced by Size

### 2. Size

Tabletop Size	Code	Price
<b>Round</b>		
24"	TR2424	\$239
30"	TR3030	\$252
36"	TR3636	\$289
42"	TR4242	\$328
<b>Square</b>		
24"	TS2424	\$239
30"	TS3030	\$252
36"	TS3636	\$289
42"	TS4242	\$328

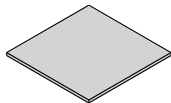
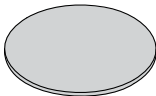

Actual size of 30" x 30" tabletop is 30.75" x 30.75".

### 3. Edge

Edge Profile	Code	Price
Edgeband	TE5	+ \$0

### 4. Tabletop Finish

Laminate Color	Code	Price
<b>Grade 1 Laminate</b>		
Ankara Cherry	TL18	Priced by Grade
Black	TL19	Priced by Grade
Brazilian Walnut	TL20	Priced by Grade
Cabinet Maple	TL21	Priced by Grade
Driftwood	TL23	Priced by Grade
Folkstone Grey	TL24	Priced by Grade
Libretti	TL25	Priced by Grade
Queenston Oak	TL26	Priced by Grade
Sandalwood	TL27	Priced by Grade
Walnut Amati	TL28	Priced by Grade
White	TL29	Priced by Grade
<b>Grade 2 Laminate</b>		
Classic Linen	TL17	Priced by Grade
Colombian Walnut	TL55	Priced by Grade
Crisp Linen	TL64	Priced by Grade
Designer White	TL66	Priced by Grade
Field Elm	TL13	Priced by Grade
Frosty White	TL16	Priced by Grade
Grey	TL62	Priced by Grade
Grey Elm	TL51	Priced by Grade
Kingswood Walnut	TL53	Priced by Grade
Manitoba	TL56	Priced by Grade
Neo Walnut	TL50	Priced by Grade
Platinum	TL61	Priced by Grade
Portico Teak	TL60	Priced by Grade
Skyline Walnut	TL15	Priced by Grade
Steel Mesh	TL59	Priced by Grade
Tuscan Walnut	TL57	Priced by Grade
Uptown Walnut	TL14	Priced by Grade

#### 4. Tabletop Finish (Cont.)

Laminate Grade	Code	Price
<b>24" Wide</b>		
Grade 1 Laminate	GR1	+ \$0
Grade 2 Laminate	GR2	+ \$120
<b>30" Wide</b>		
Grade 1 Laminate	GR1	+ \$0
Grade 2 Laminate	GR2	+ \$126
<b>36" Wide</b>		
Grade 1 Laminate	GR1	+ \$0
Grade 2 Laminate	GR2	+ \$145
<b>42" Wide</b>		
Grade 1 Laminate	GR1	+ \$0
Grade 2 Laminate	GR2	+ \$164



*Bar-Height Table*  
 Stools sold separately. See page 228 for Lumin.

## 1. Product

Product Type	Code	Price	
Table Base	3272	Priced by Column Height	
Base Style	Code	Price	

X-Base

TBT4

\$330

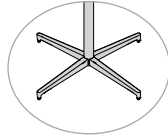

## 2. Size

Table Top Size	Code	Price	
<b>Round</b>			
24"	TR2424	+ \$0	
30"	TR3030	+ \$0	
36"	TR3636	+ \$0	
42"	TR4242	+ \$0	
<b>Square</b>			
24"	TS2424	+ \$0	
30"	TS3030	+ \$0	
36"	TS3636	+ \$0	
42"	TS4242	+ \$0	

Table bases require the specification of a tabletop size. Bases take their size from their corresponding top size.



Occasional Table

## CAFÉ AND OCCASIONAL TABLE BASE

TOPS AND BASES ARE SPECIFIED AND SOLD SEPARATELY.

## 2. Size (Cont.)

Column Height	Code	Price	
<b>Occasional</b>			
16"	TH16	- \$95	
20"	TH20	- \$85	
<b>Café</b>			
29"	TH29	+ \$0	
36"	TH36	+ \$10	
42"	TH42	+ \$21	

## 3. Base Finish

Paint Color	Code	Price	
Silver	BF01	+ \$0	
White	BF02	+ \$0	
Black	BF03	+ \$0	

## 4. Feet

Foot Style	Code	Price	
Fixed / Glides	LS18	+ \$0	

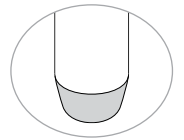

Glide color will match base finish color.

## SPECIFICATIONS

Tabletop Size	24"	30"	36"	42"
Diagonal Base Footprint	22.75"	22.75"	34.25"	38.25"
Square Base Footprint	16.09"	16.09"	24.22"	27.05"

# Switchback

## 2-LEG HEIGHT-ADJUSTABLE TABLE BUNDLE

### *Find your fit.*

Create a smarter workplace solution with Switchback, our number one height-adjustable table. Known for its class-leading anti-collision technology, compact shipping size and instant installation, it's the go-to for a dynamic workspace—and it gets even better when you bundle it with screens, power modules and keyboard trays for a complete, multifunctional workstation.



EFFECTIVE DECEMBER 1, 2021

### Featured Bundle

#### **ALL-IN-ONE :: \$4,253**

2-leg 3-stage base, fixed glides, 24" x 60" pre-drilled rectangular tabletop, no grommets, height-adjustable screen mount, 30" x 60" fabric screen, wire basket with power strip, laptop tray with HAT mechanism and U-brackets for crossrails, mini platform keyboard tray with mini trackless mechanism, half moon pencil drawer, Current clamp mount power module, Unity G2 single screen monitor arm, mobile pedestal with upholstered pad

## Features

- The bundle can be built with any of Switchback's 2-leg models
- Switchback has three available base finishes and eleven tabletop finishes to fit your style
- Bundles have easy specification and installation; order together and the pilot holes for the accessories will be predrilled and ready to go
- Multiple monitor arm choices, including heavy duty options that support up to 33 lb
- Wire management and power module options to keep all of your electronics organized and powered on

### 1. Switchback Tabletop

Product Type	Code	Price
Top for 2-Leg Base	3161	Priced by Size
Product Style	Code	Price
2-Stage T-Leg Base	TBT6	Priced by Size
3-Stage T-Leg Base	TBT7	Priced by Size
2-Stage C-Leg Base	TBT6C	Priced by Size
3-Stage, C-Leg Base	TBT7C	Priced by Size
Tabletop Size (D x W)	Code	Price
24" x 60"	TZ2460	\$287
24" x 66"	TZ2466	\$318
24" x 72"	TZ2472	\$345
30" x 60"	TZ3060	\$359
30" x 66"	TZ3066	\$395
30" x 72"	TZ3072	\$430

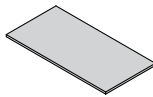

## SWITCHBACK BUNDLE

### 1. Switchback Tabletop (Cont.)

Laminate	Code	Price
Ankara Cherry	TL18	+ \$0
Black	TL19	+ \$0
Brazilian Walnut	TL20	+ \$0
Cabinet Maple	TL21	+ \$0
Driftwood	TL23	+ \$0
Folkstone Grey	TL24	+ \$0
Libretti	TL25	+ \$0
Queenston Oak	TL26	+ \$0
Sandalwood	TL27	+ \$0
Walnut Amati	TL28	+ \$0
White	TL29	+ \$0

Grommet Location	Code	Price
None	GP00	+ \$0
Left	GP01	+ \$30
Center	GP02	+ \$30
Right	GP03	+ \$30
Left and Center	GP04	+ \$60
Left and Right	GP05	+ \$60
Right and Center	GP06	+ \$60
Left, Right and Center	GP07	+ \$90

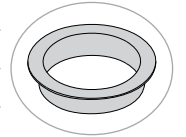

Grommet Color	Code	Price
Black	GC01	+ \$0
White	GC02	+ \$0

Pilot Holes	Code	Price
Pre-Drilled for Accessories	BNDL01	+ \$0

### 2. Switchback 2-Leg Base

Product Type	Code	Price
2-Leg Base	3162	Priced by Style
Base Style	Code	Price
2-Stage T-Leg Base	TBT6	\$814
3-Stage T-Leg Base	TBT7	\$936
2-Stage C-Leg Base	TBT6C	\$814
3-Stage C-Leg Base	TBT7C	\$936

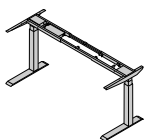
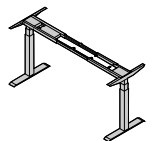

# SWITCHBACK

EFFECTIVE DECEMBER 1, 2021

## 2. Switchback 2-Leg Base (Cont.)

Tabletop Size (D x W)	Code	Price
24" x 60"	TZ2460	+ \$0
24" x 66"	TZ2466	+ \$0
24" x 72"	TZ2472	+ \$0
30" x 60"	TZ3060	+ \$0
30" x 66"	TZ3066	+ \$0
30" x 72"	TZ3072	+ \$0
Paint Color	Code	Price
Silver	BF01	+ \$0
White	BF02	+ \$0
Black	BF03	+ \$0
Foot Style	Code	Price

Glides

LS18

+ \$0

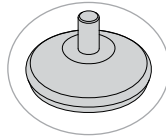

Casters

LS19

+ \$109

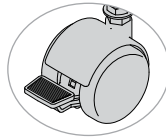

## 3. Screens

Product Type	Code	Price
Screen	3163	Priced by Size
Mount Style	Code	Price
Midway	MT5	+ \$76
Height-Adjustable	MT6	+ \$80
Screen Material	Code	Price
Frosted Acrylic	DT101	+ \$0
Fabric	DT701	+ \$0
Markerboard	DT301	+ \$0

Midway

MT5

+ \$76

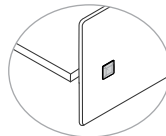

Height-Adjustable

MT6

+ \$80

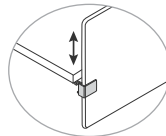

## SWITCHBACK BUNDLE

## 3. Screens (Cont.)

Screen Size	Code	Price
<b>Frosted Acrylic</b>		
24" x 60"	DS2460	+ \$499
24" x 66"	DS2466	+ \$548
24" x 72"	DS2472	+ \$599
30" x 60"	DS3060	+ \$624
30" x 66"	DS3066	+ \$685
30" x 72"	DS3072	+ \$747
<b>Fabric</b>		
24" x 60"	DS2460	+ \$518
24" x 66"	DS2466	+ \$574
24" x 72"	DS2472	+ \$638
30" x 60"	DS3060	+ \$626
30" x 66"	DS3066	+ \$644
30" x 72"	DS3072	+ \$661
<b>Markerboard</b>		
24" x 60"	DS2460	+ \$462
24" x 66"	DS2466	+ \$508
24" x 72"	DS2472	+ \$553
30" x 60"	DS3060	+ \$559
30" x 66"	DS3066	+ \$614
30" x 72"	DS3072	+ \$670

Height-adjustable mount only available with 30" x 60" screen.

## 4. Wire Management

Product Type	Code	Price
Cable Caddy	3152 WM03	\$156
Cable Caddy Basket	3152 WM05	\$85
Cable Caddy Clips	3152 WM01	\$71
Cable Caddy Slim	3152 WM02	\$55

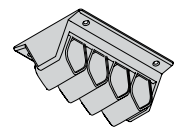
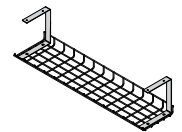
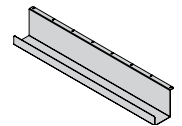

# SWITCHBACK

EFFECTIVE DECEMBER 1, 2021

## 5. Power Strip

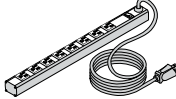
Product Type	Code	Price	
Power Strip	3130 PST1 WM00	+ \$191	

## 6. Laptop Tray

Product Type	Code	Price	
Laptop Tray	3154	Priced by Style	
Mechanism Style	Code	Price	
HAT	KBM01	+ \$134	
Platform Style	Code	Price	
Laptop Tray	KBP01	+ \$137	
Brackets	Code	Price	
U-Brackets for Crossrails	KBTA	+ \$100	

## 7. Keyboard Tray

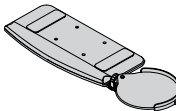
Product Type	Code	Price	
Keyboard Tray	3151	Priced by Style	
Mechanism Style	Code	Price	
Mini Trackless	KBM04	+ \$290	
Platform Style	Code	Price	
Mini Platform	KBP03	+ \$287	

## 8. Pencil Storage

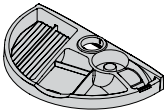
Product Type	Code	Price	
Half Moon	3155 PDT02	+ \$109	

# SWITCHBACK BUNDLE

## 9. Power Module

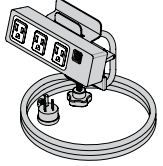
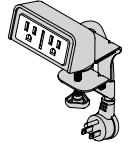
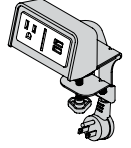
Product Type	Code	Price	
Power	3130	Priced by Style	
Product Style	Code	Price	
Current With Clamp Mount	PCC	+ \$244	
EON Clamp On, Dual Outlet	PTC PT5	+ \$112	
EON Clamp On, Single Outlet, Dual USB	PTC PT2	+ \$163	
Power Color	Code	Price	
White	PC4	+ \$0	
Black	PC1	+ \$0	

## 10. Monitor Arm

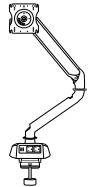
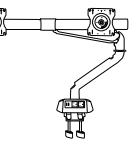
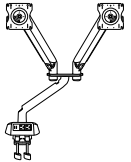
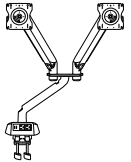
Product Type	Code	Price	
King Cobra Monitor Arm	3101	Priced by Style	
Unity G2 Monitor Arm	3111	Priced by Style	
Mobio Monitor Arm	3210	Priced by Style	
Product Style	Code	Price	
<b>King Cobra</b>			
Single Screen Light Duty	MAT01	+ \$601	
Single Screen Heavy Duty	MAT02	+ \$631	
Dual Screen Array Heavy Duty	MAT03	+ \$703	
Dual Screen High-Splitter Heavy Duty	MAT04	+ \$878	



# SWITCHBACK

EFFECTIVE DECEMBER 1, 2021

## 10. Monitor Arm (Cont.)

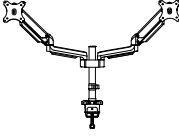
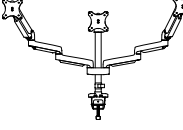
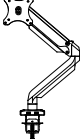
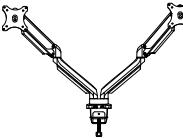
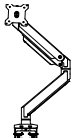
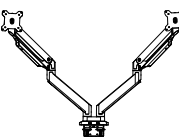
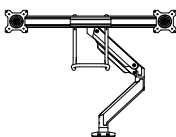
Product Style	Code	Price	
<b>Mobio</b>			
Single Pole	MAT30	+ \$346	
Dual Pole	MAT31	+ \$624	
Triple Pole	MAT32	+ \$724	
Single Desk	MAT33	+ \$272	
Dual Desk	MAT34	+ \$543	
Heavy Duty Single Desk	MAT35	+ \$424	
Heavy Duty Dual Desk	MAT36	+ \$951	
Heavy Duty Dual Array	MAT37	+ \$630	

## SWITCHBACK BUNDLE

## 10. Monitor Arm (Cont.)

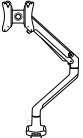
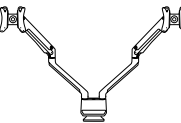

Product Style	Code	Price	
<b>Unity G2</b>			
Single Monitor Arm	MAT06	+ \$301	
Dual Monitor Arm	MAT07	+ \$600	

Paint Color	Code	Price	
Black	MAC03	+ \$0	
Silver	MAC01	+ \$0	
White	MAC02	+ \$0	

King Cobra and Mobio HD monitor arms are available in silver only. Black finish available on Mobio monitor arms only (not available on heavy duty models).

## 11. Mobile Pedestal

Product Type	Code	Price	
Mobile Pedestal	3150	Priced by Style	

Product Style	Code	Price	
No Upholstered Pad	CPT00	+ \$320	
Upholstered Pad	CPT01	+ \$446	

Paint Color	Code	Price	
Silver	PDC01	+ \$0	
White	PDC02	+ \$0	

Fabric Grade (CPT01 Only)	Code	Price	
Grade 1	FG1	+ \$0	
Grade 2	FG2	+ \$11	
Grade 3	FG3	+ \$30	
Grade 4	FG4	+ \$52	
Grade 5	FG5	+ \$90	
Grade 6	FG6	+ \$127	
Grade 7	FG7	+ \$165	

Please reference the Textile Reference Guide for pricing on fabric over grade 7.

# Switchback

## 2-LEG HEIGHT-ADJUSTABLE TABLE

### *Find your fit.*

Achieving the perfect position maximizes ergonomics and minimizes fatigue or injury. With the press of a button, you can make Switchback height-adjustable table elevate the way you work while ensuring it matches your unique needs. Configure your Switchback with a variety of leg options and an extensive portfolio of tabletop shapes and workstation add-ons. All that and quick installation make Switchback a leading solution in simplicity and endless versatility.



3-Stage T-Leg  
Chair sold separately; see page 69 for Focus 2.0

EFFECTIVE DECEMBER 1, 2021

### Featured Models

#### **2-STAGE T-LEG :: \$1,101**

2-Stage T-leg base, 24" x 60"  
laminated top, no grommets

#### **3-STAGE T-LEG :: \$1,295**

3-Stage T-leg base, 30" x 60"  
laminated top, no grommets

#### **3-STAGE C-LEG :: \$1,366**

3-Stage C-leg base, 30" x 72"  
laminated top, no grommets

# SWITCHBACK

EFFECTIVE DECEMBER 1, 2021 | GSA SIN #: 33721

## 2-LEG HEIGHT-ADJUSTABLE TABLE

TOPS AND BASES ARE SPECIFIED AND SOLD SEPARATELY.

### Features

- Gyro anti-collision technology from a patented sensor stops (and retracts) the table when it makes contact with any object
- Push-button controls with four user-customized positions
- Available with T-leg or C-leg options
- Eleven different durable laminate options to fit your style
- Three durable powder-coated metal base finishes in silver, black or white
- Optional grommets for easy and clean setup of electronic devices
- Chicago Code Compliant (3-conductor type cord with grounded 3-prong molded case plug)
- Meets G1 ANSI BIFMA Certification

### SPECIFICATIONS

	3161 TBT6/ TBT6C 2-Stage Switchback	3161 TBT8/ TBT7C 3-Stage Switchback
Height Range	27.9"-47.625"	22.6"-48.7"
Foot Length With 24" Wide Tabletop	21.65" (T-Leg) 22.83" (C-Leg)	21.65" (T-Leg) 22.83" (C-Leg)
Foot Length With 30" Wide Tabletop	29.53"	29.53"
Tabletop Thickness	1.125"	1.125"
Adjustment Speed	1.22" Per Second	1.5" Per Second
Standby Power Consumption	<0.1W	<0.1W
Noise	Approximately 39 DB	Approximately 39 DB
Power Cord Length	98.5"	98.5"
Weight Capacity Warranty	220 lb	265 lb

*Height range includes 1.125" tabletop.*



**3-Stage C-Leg**

*Chair sold separately; see page 178 for Wit.*

# SWITCHBACK

EFFECTIVE DECEMBER 1, 2021 | GSA SIN #: 33721

## 1. Product

Product Type	Code	Price	
--------------	------	-------	--

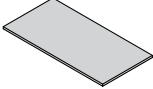
Rectangular Tabletop	3161	Priced by Size	
----------------------	------	----------------	---

Product Style	Code	Price	
---------------	------	-------	--

For 2-Stage T-Leg Base	TBT6	Priced by Size	
For 3-Stage T-Leg Base	TBT7	Priced by Size	
For 2-Stage C-Leg Base	TBT6C	Priced by Size	
For 3-Stage, C-Leg Base	TBT7C	Priced by Size	

## 2. Size

Tabletop Size (D x W)	Code	Price	
-----------------------	------	-------	--

### Standard Sizes

24" x 42"	TZ2442	\$203
24" x 48"	TZ2448	\$231
24" x 54"	TZ2454	\$259
24" x 60"	TZ2460	\$287
24" x 66"	TZ2466	\$318
24" x 72"	TZ2472	\$345
24" x 78"	TZ2478	\$374
24" x 84"	TZ2484	\$402
30" x 42"	TZ3042	\$253
30" x 48"	TZ3048	\$287
30" x 54"	TZ3054	\$325
30" x 60"	TZ3060	\$359
30" x 66"	TZ3066	\$395
30" x 72"	TZ3072	\$430
30" x 78"	TZ3078	\$467
30" x 84"	TZ3084	\$502

### For Use with eBEAM (-2")

24" x 46"	TZ2446	\$231
24" x 58"	TZ2458	\$287
24" x 70"	TZ2470	\$345
30" x 46"	TZ3046	\$287
30" x 58"	TZ3058	\$359
30" x 70"	TZ3070	\$430

## TABLETOP FOR 2-LEG BASE

TOPS AND BASES ARE SPECIFIED AND SOLD SEPARATELY.

## 3. Top Finish

Laminate	Code	Price	
----------	------	-------	--

Ankara Cherry	TL18	+ \$0
Black	TL19	+ \$0
Brazilian Walnut	TL20	+ \$0
Cabinet Maple	TL21	+ \$0
Driftwood	TL23	+ \$0
Folkstone Grey	TL24	+ \$0
Libretti	TL25	+ \$0
Queenston Oak	TL26	+ \$0
Sandalwood	TL27	+ \$0
Walnut Amati	TL28	+ \$0
White	TL29	+ \$0

## 4. Grommets

Grommet Location	Code	Price	
------------------	------	-------	--

None	GP00	+ \$0
Left	GP01	+ \$30
Center	GP02	+ \$30
Right	GP03	+ \$30
Left and Center	GP04	+ \$60
Left and Right	GP05	+ \$60
Right and Center	GP06	+ \$60
Left, Right and Center	GP07	+ \$90

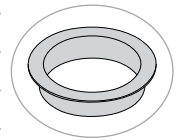

Grommet Color	Code	Price	
---------------	------	-------	--

Black	GC01	+ \$0
White	GC02	+ \$0

# SWITCHBACK

EFFECTIVE DECEMBER 1, 2021 | GSA SIN #: 33721

## 1. Product

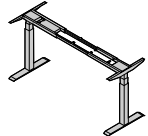
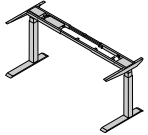
Product Type	Code	Price	
Switchback 2-Leg Base	3162	Priced by Style	
Product Style	Code	Price	
2-Stage T-Leg Base	TBT6	\$814	
3-Stage T-Leg Base	TBT7	\$936	
2-Stage C-Leg Base	TBT6C	\$814	
3-Stage C-Leg Base	TBT7C	\$936	

## 2. Size

Tabletop Size (D x W)	Code	Price	
24" x 42"	TZ2442	+\$0	
24" x 48"	TZ2448	+\$0	
24" x 54"	TZ2454	+\$0	
24" x 60"	TZ2460	+\$0	
24" x 66"	TZ2466	+\$0	
24" x 72"	TZ2472	+\$0	
24" x 78"	TZ2478	+\$0	
24" x 84"	TZ2484	+\$0	
30" x 42"	TZ3042	+\$0	
30" x 48"	TZ3048	+\$0	
30" x 54"	TZ3054	+\$0	
30" x 60"	TZ3060	+\$0	
30" x 66"	TZ3066	+\$0	
30" x 72"	TZ3072	+\$0	
30" x 78"	TZ3078	+\$0	
30" x 84"	TZ3084	+\$0	

Bases require the specification of a tabletop size. Bases take their size from their corresponding tabletop size.

## 2-LEG HEIGHT-ADJUSTABLE BASE

TOPS AND BASES ARE SPECIFIED AND SOLD SEPARATELY.

## 3. Base Finish

Paint Color	Code	Price	
Silver	BF01	+\$0	
White	BF02	+\$0	
Black	BF03	+\$0	

## 4. Feet

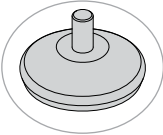
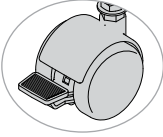
Foot Style	Code	Price	
Glides	LS18	+\$0	
Casters	LS19	+\$109	

# Switchback

## 3-LEG HEIGHT-ADJUSTABLE TABLE TYPICALS

### *Find your fit.*

Achieving the perfect position maximizes ergonomics and minimizes fatigue or injury. With the press of a button, you can make the Switchback height-adjustable table elevate the way you work while ensuring it matches your unique needs. Configure your height-adjustable table with a variety of leg options and an extensive portfolio of top shapes and workstation add-ons. All that and quick installation make Switchback a leading solution in simplicity and endless versatility.



T-Shape Collaborative



U-Shape



Pod



Extended Offset U-Shape



Extended Offset Corner With Return

### 1. Pod Typical

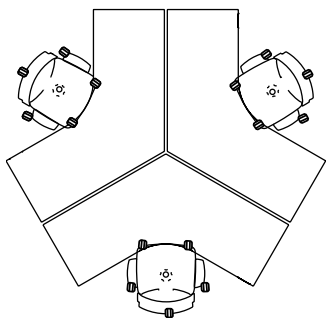
Category	Code	Quantity	Description	List Price	Ext. Price	
Tabletop	3161 TBT8C TA2448 TL27 GP00	3	120-Degree Tabletop: 24" x 48", Laminate, No Grommets	\$807	\$2,421	
Table Base	3162 TBT8C TA2448 BF01	3	3-Leg Base (Pairs With 24" x 48" 120-Degree Tabletop)	\$1,588	\$4,764	

**TOTAL: \$7,185**

### 2. U-Shape Typical

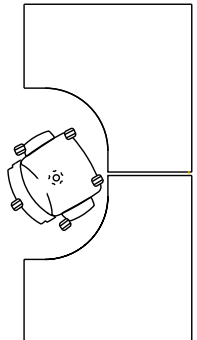
Category	Code	Quantity	Description	List Price	Ext. Price	
Tabletop	3161 TBT8C TBCR2448 TL27 GP00	1	Right 90-Degree Tabletop: 24" x 48", Laminate, No Grommets	\$460	\$460	
Tabletop	3161 TBT8C TBCL2448 TL27 GP00	1	Left 90-Degree Tabletop: 24" x 48", Laminate, No Grommets	\$460	\$460	
Table Base	3162 TBT8C TBCL2448 BF01	1	3-Leg Base (Pairs With 24" x 48" 90-Degree Left Tabletop)	\$1,588	\$1,588	
Table Base	3162 TBT8C TBCR2448 BF01	1	3-Leg Base (Pairs With 24" x 48" 90-Degree Right Tabletop)	\$1,588	\$1,588	

**TOTAL: \$4,096**

### 3. Extended Offset U-Shape Typical

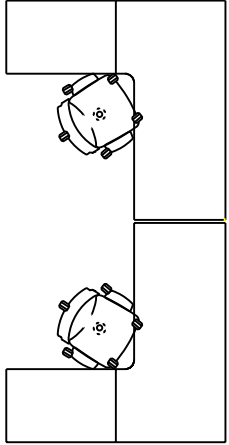
Category	Code	Quantity	Description	List Price	Ext. Price	
Tabletop	3161 TBT8C OR24367230 TL27 GP00	1	Right Extended Offset Corner Tabletop: 24" x 36" x 72" x 30", Laminate, No Grommets	\$609	\$609	
Tabletop	3161 TBT8C OL30723624 TL27 GP00	1	Left Extended Offset Corner Tabletop: 30" x 72" x 36" x 24", Laminate, No Grommets	\$609	\$609	
Return Top	3164 TBT8C TN2436 TL27 GPR00	2	Return Top: 24" x 36", Laminate, No Grommets	\$174	\$348	
Table Base	3162 TBT8C TBCR3048 TN2436 BF01	1	3-Leg Base (Pairs With 24" x 36" x 72" x 30" Right Extended Offset Corner Tabletop)	\$1,812	\$1,812	
Table Base	3162 TBT8C TBCL3048 TN2436 BF01	1	3-Leg Base (Pairs With 30" x 72" x 36" x 24" Left Extended Offset Corner Tabletop)	\$1,812	\$1,812	

**TOTAL: \$5,190**

### 4. Extended Offset Corner With Return Typical

Category	Code	Quantity	Description	List Price	Ext. Price	
Tabletop	3161 TBT8C OL30723624 TL27 GP00	1	Left Extended Offset Corner Tabletop: 24" x 36" x 72" x 30", Laminate, No Grommets	\$609	\$609	
Return Top	3164 TBT8C TN2436 TL27 GPR00	1	Return Top: 24" x 36", Laminate, No Grommets	\$174	\$174	
Table Base	3162 TBT8C OL30723624 TN2436 BF01	1	3-Leg Base (Pairs With 24" x 36" x 72" x 30" Left Extended Corner Tabletop)	\$1,812	\$1,812	

**TOTAL: \$2,595**

### 5. T-Shape Collaborative Typical

Category	Code	Quantity	Description	List Price	Ext. Price	
Tabletop	3161 TBT8C TZ3072 TL27 GP00	2	Rectangular Tabletop: 30" x 72", Laminate, No Grommets	\$430	\$860	
Return Top	3164 TBT8C TN2442 TL27 GPR00	2	Return Top: 24" x 42", Laminate, No Grommets	\$203	\$406	
Table Base	3162 TBT8C TZ3072 TN2442 BF01	2	3-Leg Base (Pairs With 30" x 72" Tabletop and Return)	\$1,812	\$3,624	

**TOTAL: \$4,890**



# Switchback

## 3-LEG HEIGHT-ADJUSTABLE TABLE

### *Find your fit.*

Achieving the perfect position maximizes ergonomics and minimizes fatigue or injury. With the press of a button, you can make the Switchback height-adjustable table elevate the way you work while ensuring it matches your unique needs. Configure your Switchback with a variety of leg options and an extensive portfolio of tabletop shapes and workstation add-ons. All that and quick installation make Switchback a leading solution in simplicity and endless versatility.



*3-Leg 120-Degree  
Chair sold separately;  
see page 174 for Vectra*

**EFFECTIVE DECEMBER 1, 2021**

### Featured Models

#### **3-LEG 90° :: \$2,161**

3-leg base with 24" x 60"  
90° corner tabletop

#### **3-LEG 120° :: \$2,395**

3-leg base with 24" x 48"  
120° tabletop

#### **3-LEG EXTENDED :: \$2,633**

3-leg base with 24" x 48" x 72" right  
extended corner tabletop,  
24" x 24" return top

### Features

- Gyro anti-collision technology from a patented sensor stops (and retracts) the table when it makes contact with any object
- Push-button controls with four user-customized positions
- C-leg base
- Eleven different durable laminate options to fit your style
- Three durable powder-coated metal finishes in silver, black or white
- Optional grommets for easy and clean setup of electronic devices
- Chicago Code Compliant (3-conductor type cord with grounded 3-prong molded case plug)
- Meets G1 ANSI BIFMA Certification

### SPECIFICATIONS

	C-Leg Switchback
Height Range	22.6"-48.7"
Foot Length With 24" Wide Tabletop	22.83"
Foot Length With 30" Wide Tabletop	29.53"
Tabletop Thickness	1.125"
Adjustment Speed	1.5" Per Second
Standby Power Consumption	<0.1W
Noise	Approximately 39 DB
Power Cord Length	98.5"
Weight Capacity Warranty	265 lb

*Height range includes 1.125" tabletop.*



*3-Leg Extended Corner  
Chair sold separately;  
see page 123 for Novo.*

## 1-PIECE TABLETOP FOR 3-LEG BASE

TOPS AND BASES ARE SPECIFIED AND SOLD SEPARATELY.

### 1. Product

Product Type	Code	Price	
Tabletop	3161	Priced by Size	
Product Style	Code	Price	
For Switchback 3-Leg 3-Stage C-Leg Base	TBT8C	Priced by Size	

### 2. Size

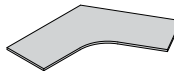
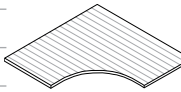
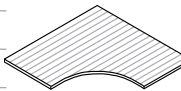
Tabletop Size (D x W)	Code	Price	
<b>120-Degree Tabletop</b>			
24" x 42"	TA2442	\$626	
24" x 48"	TA2448	\$807	
30" x 42"	TA3042	\$654	
30" x 48"	TA3048	\$816	
Tabletop Size (D x W)	Code	Price	
<b>Right 90-Degree Corner Tabletop</b>			
24" x 48" Right	TBCR2448	\$460	
24" x 54" Right	TBCR2454	\$517	
24" x 60" Right	TBCR2460	\$573	
30" x 48" Right	TBCR3048	\$573	
30" x 54" Right	TBCR3054	\$648	
30" x 60" Right	TBCR3060	\$716	
<b>Left 90-Degree Corner Tabletop</b>			
24" x 48" Left	TBCL2448	\$460	
24" x 54" Left	TBCL2454	\$517	
24" x 60" Left	TBCL2460	\$573	
30" x 48" Left	TBCL3048	\$573	
30" x 54" Left	TBCL3054	\$648	
30" x 60" Left	TBCL3060	\$716	

### 3. Top Finish

Laminate	Code	Price	
Ankara Cherry	TL18	+ \$0	
Black	TL19	+ \$0	
Brazilian Walnut	TL20	+ \$0	
Cabinet Maple	TL21	+ \$0	
Driftwood	TL23	+ \$0	
Folkstone Grey	TL24	+ \$0	
Libretti	TL25	+ \$0	
Queenston Oak	TL26	+ \$0	
Sandalwood	TL27	+ \$0	
Walnut Amati	TL28	+ \$0	
White	TL29	+ \$0	

### 4. Grommets

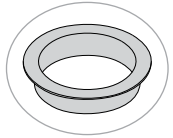
Grommet Location	Code	Price	
None	GPR00	+ \$0	
Left	GPR01	+ \$30	
Center	GPR02	+ \$30	
Right	GPR03	+ \$30	
Left and Center	GPR04	+ \$60	
Left and Right	GPR05	+ \$60	
Right and Center	GPR06	+ \$60	
Left, Right and Center	GPR07	+ \$90	
Grommet Color	Code	Price	
Black	GC01	+ \$0	
White	GC02	+ \$0	

# SWITCHBACK

EFFECTIVE DECEMBER 1, 2021 | GSA SIN #: 33721

## 1. Product

Product Type	Code	Price	
Switchback 3-Leg Base	3162	Priced by Style	
Product Style	Code	Price	

3-Stage C-Leg Base TBT8C \$1,588

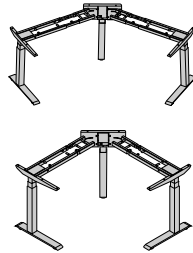

## 2. Size

Tabletop Size	Code	Price	
Depth x Width	120-Degree Top		
24" x 42"	TA2442	+ \$0	
24" x 48"	TA2448	+ \$0	
30" x 42"	TA3042	+ \$0	
30" x 48"	TA3048	+ \$0	

## 3-LEG BASE FOR 1-PIECE TOP

TOPS AND BASES ARE SPECIFIED AND SOLD SEPARATELY.

## 2. Size (Cont.)

Tabletop Size	Code	Price	
Depth x Width	Right 90-Degree Corner Tabletop		
24" x 48"	TBCR2448	+ \$0	
24" x 54"	TBCR2454	+ \$0	
24" x 60"	TBCR2460	+ \$0	
30" x 48"	TBCR3048	+ \$0	
30" x 54"	TBCR3054	+ \$0	
30" x 60"	TBCR3060	+ \$0	
Depth x Width	Left 90-Degree Corner Tabletop		
24" x 48"	TBCL2448	+ \$0	
24" x 54"	TBCL2454	+ \$0	
24" x 60"	TBCL2460	+ \$0	
30" x 48"	TBCL3048	+ \$0	
30" x 54"	TBCL3054	+ \$0	
30" x 60"	TBCL3060	+ \$0	

Bases require the specification of a tabletop size. Bases take their size from their corresponding tabletop size.

## 3. Base Finish

Paint Color	Code	Price	
Silver	BF01	+ \$0	
White	BF02	+ \$0	
Black	BF03	+ \$0	



3-Leg 120°  
Chair sold separately;  
see page 174 for Vectra

# SWITCHBACK

EFFECTIVE DECEMBER 1, 2021 | GSA SIN #: 33721

## 1. Product

Product Type	Code	Price
Switchback Tabletop	3161	Priced by Size

Product Style	Code	Price
For Switchback 3-Leg 3-Stage C-Leg Base	TBT8C	Priced by Size

## 2. Size

Tabletop Size	Code	Price
<b>Depth x Width</b>	<b>Rectangular Tabletop</b>	
24" x 48"	TZ2448	\$231
24" x 54"	TZ2454	\$259
24" x 60"	TZ2460	\$287
24" x 66"	TZ2466	\$318
24" x 72"	TZ2472	\$345
30" x 48"	TZ3048	\$287
30" x 54"	TZ3054	\$325
30" x 60"	TZ3060	\$359
30" x 66"	TZ3066	\$395
30" x 72"	TZ3072	\$430
<b>Right A x B x C</b>	<b>Extended Corner Tabletop</b>	
24" x 36" x 60"	TXR243660	\$431
24" x 36" x 66"	TXR243666	\$486
24" x 36" x 72"	TXR243672	\$549
24" x 42" x 60"	TXR244260	\$495
24" x 42" x 66"	TXR244266	\$559
24" x 42" x 72"	TXR244272	\$631
24" x 48" x 60"	TXR244860	\$544
24" x 48" x 66"	TXR244866	\$615
24" x 48" x 72"	TXR244872	\$694
30" x 36" x 60"	TXR303660	\$495
30" x 36" x 66"	TXR303666	\$559
30" x 36" x 72"	TXR303672	\$676
30" x 42" x 60"	TXR304260	\$569
30" x 42" x 66"	TXR304266	\$642
30" x 42" x 72"	TXR304272	\$726
30" x 48" x 60"	TXR304860	\$598
30" x 48" x 66"	TXR304866	\$676
30" x 48" x 72"	TXR304872	\$764

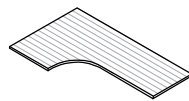
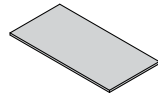

## TABLETOP FOR 3-LEG BASE AND RETURN

TOPS AND BASES ARE SPECIFIED AND SOLD SEPARATELY.

## 2. Size (Cont.)

Tabletop Size (Cont.)	Code	Price
<b>Left A x B x C</b>	<b>Extended Corner Tabletop</b>	
24" x 60" x 36"	TXL246036	\$431
24" x 66" x 36"	TXL246636	\$486
24" x 72" x 36"	TXL247236	\$549
24" x 60" x 42"	TXL246042	\$495
24" x 66" x 42"	TXL246642	\$559
24" x 72" x 42"	TXL247242	\$631
24" x 60" x 48"	TXL246048	\$544
24" x 66" x 48"	TXL246648	\$615
24" x 72" x 48"	TXL247248	\$694
30" x 60" x 36"	TXL306036	\$495
30" x 66" x 36"	TXL306636	\$559
30" x 72" x 36"	TXL307236	\$676
30" x 60" x 42"	TXL306042	\$569
30" x 66" x 42"	TXL306642	\$642
30" x 72" x 42"	TXL307242	\$726
30" x 60" x 48"	TXL306048	\$598
30" x 66" x 48"	TXL306648	\$676
30" x 72" x 48"	TXL307248	\$764
<b>Right A x B x C x D</b>	<b>Extended Offset Corner Top</b>	
24" x 36" x 60" x 30"	OR24366030	\$472
24" x 36" x 66" x 30"	OR24366630	\$537
24" x 36" x 72" x 30"	OR24367230	\$609
24" x 42" x 60" x 30"	OR24426030	\$547
24" x 42" x 66" x 30"	OR24426630	\$620
24" x 42" x 72" x 30"	OR24427230	\$705
24" x 48" x 60" x 30"	OR24486030	\$576
24" x 48" x 66" x 30"	OR24486630	\$653
24" x 48" x 72" x 30"	OR24487230	\$742
<b>Left A x B x C x D</b>	<b>Extended Offset Corner Top</b>	
30" x 60" x 36" x 24"	OL30603624	\$472
30" x 66" x 36" x 24"	OL30663624	\$537
30" x 72" x 36" x 24"	OL30723624	\$609
30" x 60" x 42" x 24"	OL30604224	\$547
30" x 66" x 42" x 24"	OL30664224	\$620
30" x 72" x 42" x 24"	OL30724224	\$705
30" x 60" x 48" x 24"	OL30604824	\$576
30" x 66" x 48" x 24"	OL30664824	\$653
30" x 72" x 48" x 24"	OL30724824	\$742

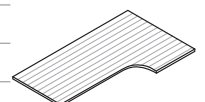
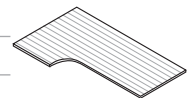
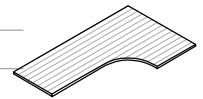

On extended corner tops, the main desk and return have equal depth.

On extended offset corner tops, the main desk has a depth of 30", which tapers down to a depth of 24" on the return.

Multipiece tops must be paired with returns. See the diagram on the following page for more information on extended corner dimensions.

### 3. Top Finish

Laminate	Code	Price
Ankara Cherry	TL18	+ \$0
Black	TL19	+ \$0
Brazilian Walnut	TL20	+ \$0
Cabinet Maple	TL21	+ \$0
Driftwood	TL23	+ \$0
Folkstone Grey	TL24	+ \$0
Libretti	TL25	+ \$0
Queenston Oak	TL26	+ \$0
Sandalwood	TL27	+ \$0
Walnut Amati	TL28	+ \$0
White	TL29	+ \$0

### 4. Grommets

Grommet Location	Code	Price
None	GP00	+ \$0
Left	GP01	+ \$30
Center	GP02	+ \$30
Right	GP03	+ \$30
Left and Center	GP04	+ \$60
Left and Right	GP05	+ \$60
Right and Center	GP06	+ \$60
Left, Right and Center	GP07	+ \$90

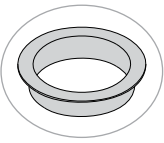

Grommet Color	Code	Price
Black	GC01	+ \$0
White	GC02	+ \$0

Left grommets (GP01/GP04/GP05/GP07) are not available on right extended corners or right extended offset corners.

Right grommets (GP03/GP05/GP06/GP07) are not available on left extended corners or left extended offset corners.

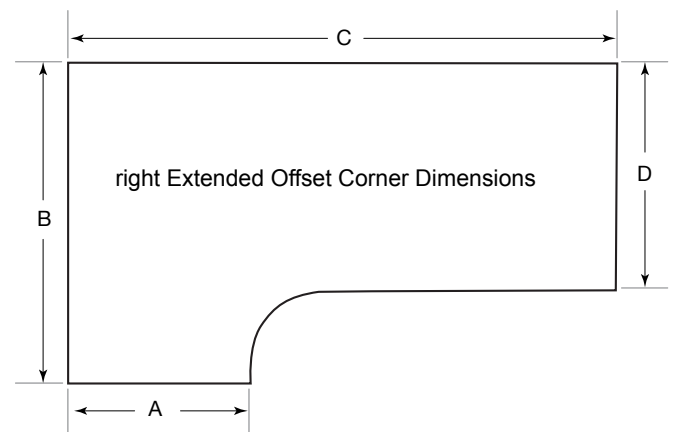
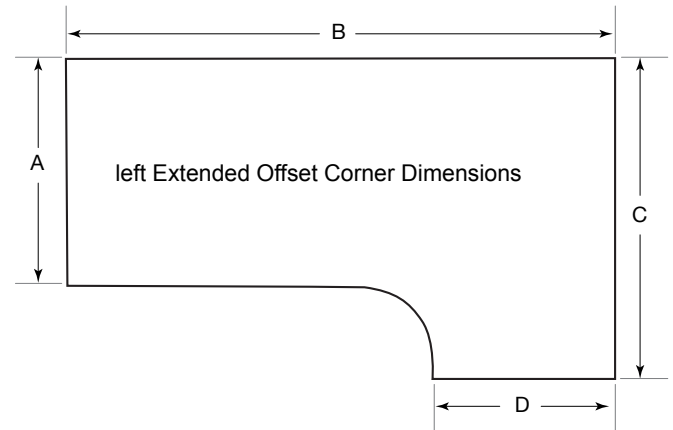

# SWITCHBACK

EFFECTIVE DECEMBER 1, 2021 | GSA SIN #: 33721

## 1. Product

Product Type	Code	Price	
Return Top	3164	Priced by Size	
Product Style	Code	Price	
For Switchback 3-Leg 3-Stage C-Leg Base	TBT8C	Priced by Size	

## 2. Size

Return Top Size (D x W)	Code	Price	
24" x 24"	TN2424	\$127	
24" x 30"	TN2430	\$146	
24" x 36"	TN2436	\$174	
24" x 42"	TN2442	\$203	
24" x 48"	TN2448	\$231	
30" x 24"	TN3024	\$152	
30" x 30"	TN3030	\$181	
30" x 36"	TN3036	\$217	
30" x 42"	TN3042	\$253	

## 3. Tabletop Finish

Laminate	Code	Price	
Ankara Cherry	TL18	+ \$0	
Black	TL19	+ \$0	
Brazilian Walnut	TL20	+ \$0	
Cabinet Maple	TL21	+ \$0	
Driftwood	TL23	+ \$0	
Folkstone Grey	TL24	+ \$0	
Libretti	TL25	+ \$0	
Queenston Oak	TL26	+ \$0	
Sandalwood	TL27	+ \$0	
Walnut Amati	TL28	+ \$0	
White	TL29	+ \$0	

## RETURN TOP FOR 3-LEG BASE

TOPS AND BASES ARE SPECIFIED AND SOLD SEPARATELY.

## 4. Grommets

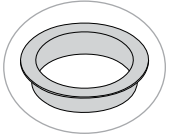
Grommet Location	Code	Price	
None	GPR00	+ \$0	
Left	GPR01	+ \$30	
Center	GPR02	+ \$30	
Right	GPR03	+ \$30	
Grommet Color	Code	Price	
Black	GC01	+ \$0	
White	GC02	+ \$0	

# SWITCHBACK

EFFECTIVE DECEMBER 1, 2021 | GSA SIN #: 33721

## 1. Base

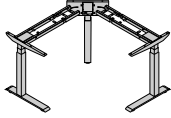
Product Type	Code	Base	
3-Leg 3-Stage C-Leg Base	3162 TBT8C	\$1,588	

## 2. Size

Tabletop Size	Code	Price	
<b>Depth x Width</b>	<b>Rectangular Tabletop</b>		
24" x 48"	TZ2448	+\$0	
24" x 54"	TZ2454	+\$0	
24" x 60"	TZ2460	+\$0	
24" x 66"	TZ2466	+\$0	
24" x 72"	TZ2472	+\$0	
30" x 48"	TZ3048	+\$0	
30" x 54"	TZ3054	+\$0	
30" x 60"	TZ3060	+\$0	
30" x 66"	TZ3066	+\$0	
30" x 72"	TZ3072	+\$0	
<b>Right A x B x C</b>	<b>Extended Corner Tabletop</b>		
24" x 36" x 60"	TXR243660	+\$0	
24" x 36" x 66"	TXR243666	+\$0	
24" x 36" x 72"	TXR243672	+\$0	
24" x 42" x 60"	TXR244260	+\$0	
24" x 42" x 66"	TXR244266	+\$0	
24" x 42" x 72"	TXR244272	+\$0	
24" x 48" x 60"	TXR244860	+\$0	
24" x 48" x 66"	TXR244866	+\$0	
24" x 48" x 72"	TXR244872	+\$0	
30" x 36" x 60"	TXR303660	+\$0	
30" x 36" x 66"	TXR303666	+\$0	
30" x 36" x 72"	TXR303672	+\$0	
30" x 42" x 60"	TXR304260	+\$0	
30" x 42" x 66"	TXR304266	+\$0	
30" x 42" x 72"	TXR304272	+\$0	
30" x 48" x 60"	TXR304860	+\$0	
30" x 48" x 66"	TXR304866	+\$0	
30" x 48" x 72"	TXR304872	+\$0	

## 3-LEG BASE FOR TABLETOP AND RETURN TOPS AND BASES ARE SPECIFIED AND SOLD SEPARATELY.

## 2. Size (Cont.)

Tabletop Size	Code	Price	
<b>Left A x B x C</b>	<b>Extended Corner Tabletop</b>		
24" x 60" x 36"	TXL246036	+\$0	
24" x 66" x 36"	TXL246636	+\$0	
24" x 72" x 36"	TXL247236	+\$0	
24" x 60" x 42"	TXL246042	+\$0	
24" x 66" x 42"	TXL246642	+\$0	
24" x 72" x 42"	TXL247242	+\$0	
24" x 60" x 48"	TXL246048	+\$0	
24" x 66" x 48"	TXL246648	+\$0	
24" x 72" x 48"	TXL247248	+\$0	
30" x 60" x 48"	TXL306036	+\$0	
30" x 66" x 36"	TXL306636	+\$0	
30" x 72" x 36"	TXL307236	+\$0	
30" x 60" x 42"	TXL306042	+\$0	
30" x 66" x 42"	TXL306642	+\$0	
30" x 72" x 42"	TXL307242	+\$0	
30" x 60" x 48"	TXL306048	+\$0	
30" x 66" x 48"	TXL306648	+\$0	
30" x 72" x 48"	TXL307248	+\$0	
<b>Right A x B x C x D</b>	<b>Extended Offset Corner Top</b>		
24" x 36" x 60" x 30"	OR24366030	+\$0	
24" x 36" x 66" x 30"	OR24366630	+\$0	
24" x 36" x 72" x 30"	OR24367230	+\$0	
24" x 42" x 60" x 30"	OR24426030	+\$0	
24" x 42" x 66" x 30"	OR24426630	+\$0	
24" x 42" x 72" x 30"	OR24427230	+\$0	
24" x 48" x 60" x 30"	OR24486030	+\$0	
24" x 48" x 66" x 30"	OR24486630	+\$0	
24" x 48" x 72" x 30"	OR24487230	+\$0	
<b>Left A x B x C x D</b>	<b>Extended Offset Corner Top</b>		
30" x 60" x 36" x 24"	OL30603624	+\$0	
30" x 66" x 36" x 24"	OL30663624	+\$0	
30" x 72" x 36" x 24"	OL30723624	+\$0	
30" x 60" x 42" x 24"	OL30604224	+\$0	
30" x 66" x 42" x 24"	OL30664224	+\$0	
30" x 72" x 42" x 24"	OL30724224	+\$0	
30" x 60" x 48" x 24"	OL30604824	+\$0	
30" x 66" x 48" x 24"	OL30664824	+\$0	
30" x 72" x 48" x 24"	OL30724824	+\$0	

Bases require the specification of a tabletop size. Bases take their size from their corresponding tabletop size.



## 3-LEG BASE FOR TABLETOP AND RETURN

TOPS AND BASES ARE SPECIFIED AND SOLD SEPARATELY.

### 3. Return Size

Return Top Size	Code	Price
No Return	TN0	+ \$0
24" x 24"	TN2424	+ \$74
24" x 30"	TN2430	+ \$74
24" x 36"	TN2436	+ \$74
24" x 42"	TN2442	+ \$74
24" x 48"	TN2448	+ \$74
30" x 24"	TN3024	+ \$74
30" x 30"	TN3030	+ \$74
30" x 36"	TN3036	+ \$74
30" x 42"	TN3042	+ \$74

### 4. Base Finish

Paint Color	Code	Price
Silver	BF01	+ \$0
White	BF02	+ \$0
Black	BF03	+ \$0

### 5. Base Extension

Parts	Code	Price
Cross Beam and Extension Cable	No Code	+ \$150

A base extension charge will be added automatically if the A or D measurement is equal to 72".

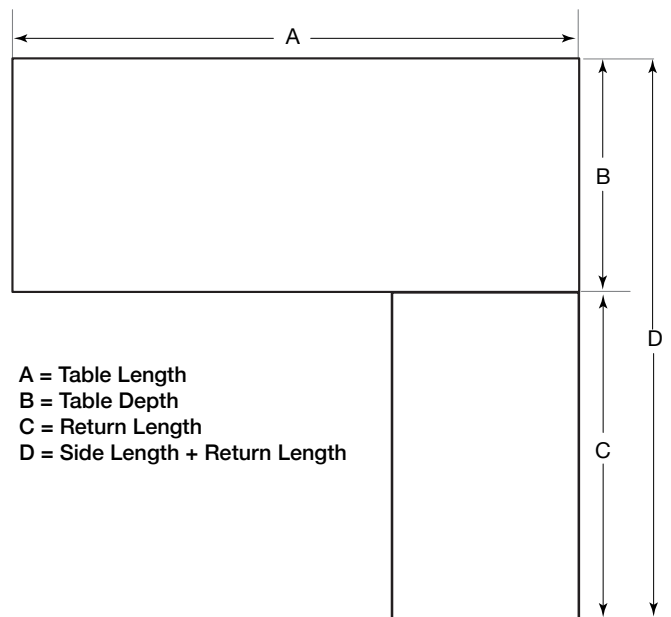
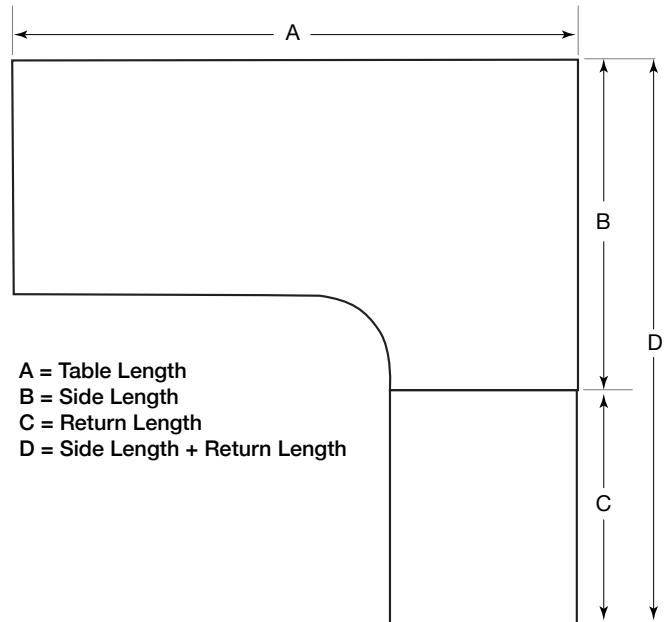

# Tensor

## CAFÉ, CLASSROOM, AND OFFICE TYPICALS

As your business grows and changes, your workspace should be able to keep up. That's why we created Tensor—one table that can adapt to your changing needs. It's the only table that can expand to support multiple tops on a single base. This allows you to install and reconfigure to fit any space quickly and easily.



L-Shaped With Main and Return



Conference



U-Shaped With Bridge



Multipurpose U-Shape





Classroom-Style Training



Café

EFFECTIVE DECEMBER 1, 2021

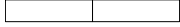
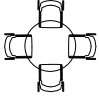
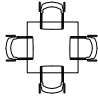
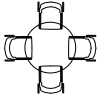
### 1. Café Typical

Category	Code	Quantity	Description	List Price	Ext Price	
Tabletop	3231 TBT9 TZ1872 TL27 GP00	2	Rectangular Tabletop: 18" x 72", Laminate, No Grommets	\$266	\$532	
Tabletop	3231 TBT9 TS4242 TL27	2	Square Tabletop: 42" x 42", Laminate	\$319	\$638	
Tabletop	3231 TBT9 TR4242 TL27	2	Round Tabletop: 42" x 42", Laminate	\$366	\$732	
Table Base	3232 TBT9 TZ1872 BF01	2	Base (Pairs With Rectangular 18" x 72" Tabletop)	\$533	\$1,066	
Table Base	3232 TBT9 TS4242 BF01	2	Base (Pairs With 42" x 42" Square Tabletop)	\$469	\$938	
Table Base	3232 TBT9 TR4242 BF01	2	Base (Pairs With 42" x 42" Round Tabletop)	\$469	\$938	

**TOTAL: \$4,844**

### 2. Classroom-Style Training Typical

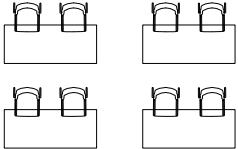
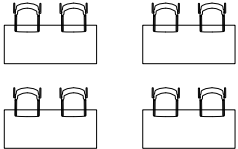
Category	Code	Quantity	Description	List Price	Ext Price	
Tabletop	3231 TBT9 TZ3072 TL24 GP00	8	Rectangular Tabletop: 30" x 72", Laminate, No Grommets	\$430	\$3,440	
Table Base	3232 TBT9 TZ3072 BF01	8	Base (Pairs With 30" x 72" Rectangular Tabletop)	\$533	\$4,264	

**TOTAL: \$7,704**

### 3. Multipurpose U-Shape Typical

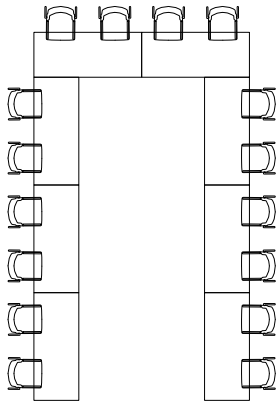
Category	Code	Quantity	Description	List Price	Ext Price	
Tabletop	3231 TBT9 TZ3072 TL22 GP00	8	Rectangular Tabletop: 30" x 72", Laminate, No Grommets	\$430	\$3,440	
Table Base	3232 TBT9 TZ3072 BF01	8	Base (Pairs With 30" x 72" Rectangular Tabletop)	\$533	\$4,264	
Accessories	3159 ATC03 XGV	7	Set of Two Ganging Brackets	\$43	\$301	

**TOTAL: \$8,005**

EFFECTIVE DECEMBER 1, 2021

### 4. Conference Typical

Category	Code	Quantity	Description	List Price	Ext Price
Tabletop	3231 TBT9 TZ2460 TL27 GP00	4	Rectangular Tabletop: 24" x 60", Laminate, No Grommets	\$287	\$1,148
Table Base	3232 TBT9 TZ2460 BF01	4	Base (Pairs With 24" x 60" Rectangular Tabletop)	\$509	\$2,036
Accessories	3159 ATC03 XGV	4	Set of Two Ganging Brackets	\$43	\$172

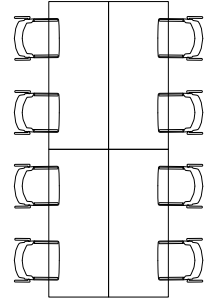

**TOTAL: \$3,356**

### 5. L-Shape Typical With Main Desk and Return

Category	Code	Quantity	Description	List Price	Ext Price
Tabletop	3231 TBT9 TZ3072 TL27 GP00	1	Rectangular Tabletop: 30" x 72", Laminate, No Grommets	\$430	\$430
Return Top	3231 TBT9P TN2448 TL27 GPR00	1	Return Top: 24" x 48", Laminate, No Grommets	\$231	\$231
Table Base	3232 TBT9 TZ3072 BF01	1	Base (Pairs With 30" x 72" Rectangular Tabletop)	\$533	\$533
Return Base	3232 TBT9P TN2448 BF01	1	Return Base (Pairs With 24" x 48" Return Top)	\$255	\$255

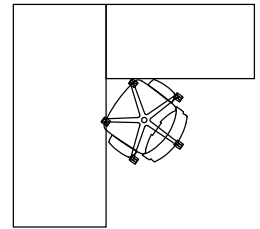

**TOTAL: \$1,449**

### 6. U-Shape Typical With Bridge

Category	Code	Quantity	Description	List Price	Ext Price
Desktop	3231 TBT9 TZ3072 TL27 GP00	1	Rectangular Desktop: 30" x 72", Laminate, No Grommets	\$430	\$430
Credenza Top	3231 TBT9 TZ2472 TL27 GP00	1	Rectangular Credenza Top: 24" x 72", Laminate, No Grommets	\$345	\$345
Bridgetop	3231 TBT10 TZ2442 TL27	1	Bridgetop: 24" x 42", Laminate	\$203	\$203
Desk Base	3232 TBT9 TZ3072 BF01	1	Base (Pairs With 30" x 72" Rectangular Tabletop)	\$533	\$533
Credenza Base	3232 TBT9 TZ2472 BF01	1	Base (Pairs With 24" x 72" Rectangular Tabletop)	\$533	\$533
Bridge Support	3232 TBT10 TZ2442	1	Mending Brackets (Pairs With 24" x 42" Bridgetop)	\$168	\$168

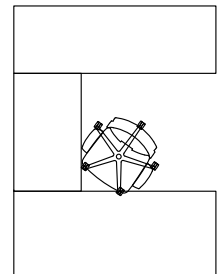

**TOTAL: \$2,212**

# Tensor

## CAFÉ TABLE

### *One table does it all.*

As your business grows and changes, your workspace should be able to keep up. That's why we created Tensor—one table that can adapt to your changing needs. It's the only table that can expand to support multiple top shapes and sizes with a single base. This allows you to install and reconfigure to fit any space quickly and easily.



*Round Café Table*  
Chair sold separately; see page 194 for Baja .

**EFFECTIVE DECEMBER 1, 2021**

### Featured Models

#### **SQUARE :: \$788**

42" square tabletop and matching base

#### **ROUND :: \$835**

42" round tabletop and matching base

## Features

- Patent-pending easy-to-size table support structure adapts to all spaces
- Steel dual-isosceles triangle design evenly distributes and supports weight throughout
- Base accommodates round and square tabletops  
Round from 42"-48"; Square from 30"-48"
- Features a minimalistic aesthetic with a below-the-surface configuration
- 11 different durable laminate options to fit your style
- Assembles in less than 10 minutes with pre-installed parts
- 300 lb weight capacity warranty

## SPECIFICATIONS

	Tensor Café Table
Height	29.67"
Leg Width	1.8"
Tabletop Thickness	1.125"
Weight Capacity Warranty	300 lb

Height range includes 1.125" tabletop.

## CAFÉ TABLETOP

TOPS AND BASES ARE SPECIFIED AND SOLD SEPARATELY.

### 1. Product

Product Type	Code	Price	
Tabletop	3231 TBT9	Priced by Size	

### 2. Size

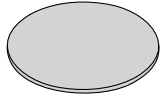
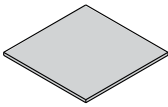
Tabletop Size	Code	Price	
<b>Round</b>			
42"	TR4242	\$366	
48"	TR4848	\$414	
<b>Square</b>			
30"	TS3030	\$246	
36"	TS3636	\$282	
42"	TS4242	\$319	
48"	TS4848	\$360	

Actual size of 30" x 30" tabletop is 30.75" x 30.75".

### 3. Top Finish

Laminate	Code	Price	
Ankara Cherry	TL18	+ \$0	
Black	TL19	+ \$0	
Brazilian Walnut	TL20	+ \$0	
Cabinet Maple	TL21	+ \$0	
Driftwood	TL23	+ \$0	
Folkstone Grey	TL24	+ \$0	
Libretti	TL25	+ \$0	
Queenston Oak	TL26	+ \$0	
Sandalwood	TL27	+ \$0	
Walnut Amati	TL28	+ \$0	
White	TL29	+ \$0	

## CAFÉ TABLETOP

TOPS AND BASES ARE SPECIFIED AND SOLD SEPARATELY.

### 1. Product

Product Type	Code	Price
Base	3232 TBT9	\$469

### 2. Size

Tabletop Size	Code	Price
No Tabletop	TZ0	\$0

#### Round

42"	TR4242	+\$0
48"	TR4848	+\$0

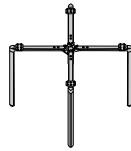

#### Square

30"	TS3030	+\$0
36"	TS3636	+\$0
42"	TS4242	+\$0
48"	TS4848	+\$0

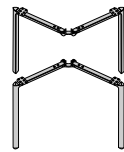

Table bases require the specification of a tabletop size. Bases take their size from their corresponding top size.

### 3. Base Finish

Paint Color	Code	Price
Silver	BF01	+\$0
White	BF02	+\$0
Black	BF03	+\$0

Square Café Table  
Chair sold separately; see page 233 for Mika.



# Tensor

## MULTIPURPOSE TABLE

### *One table does it all.*

As your business grows and changes, your workspace should be able to keep up. That's why we created Tensor—one table that can adapt to your changing needs. It's the only table that can expand to support multiple top shapes and sizes with a single base. This allows you to install and reconfigure to fit any space quickly and easily.



24" x 60" Table  
Chair sold separately; see page 222 for Ioniq Multipurpose.

**EFFECTIVE DECEMBER 1, 2021**

### Featured Models

**18" x 48" :: \$686**

18" x 48" laminate tabletop and matching base

**24" x 60" :: \$796**

24" x 60" laminate tabletop and matching base

**30" x 72" :: \$963**

30" x 72" laminate tabletop and matching base



## MULTIPURPOSE TABLETOP

TOPS AND BASES ARE SPECIFIED AND SOLD SEPARATELY.

### Features

- Patent-pending easy-to-size table support structure adapts to all spaces
- Steel dual-isosceles triangle design evenly distributes and supports weight throughout
- Base accommodates tabletops from 18" (D) x 48" (W) to 30" (D) x 72" (W)
- Features a minimalistic aesthetic with a below-the-surface configuration
- 11 different durable laminate options to fit your style
- Installs in less than 10 minutes with pre-installed parts
- 300 lb weight capacity warranty

### 1. Product

Product Type	Code	Price
Tabletop	3231 TBT9	Priced by Size

### 2. Size

Tabletop Size (D x W)	Code	Price
18" x 42"	TZ1842	\$156
18" x 48"	TZ1848	\$177
18" x 54"	TZ1854	\$200
18" x 60"	TZ1860	\$220
18" x 66"	TZ1866	\$244
18" x 72"	TZ1872	\$266
24" x 36"	TZ2436	\$174
24" x 42"	TZ2442	\$203
24" x 48"	TZ2448	\$231
24" x 54"	TZ2454	\$259
24" x 60"	TZ2460	\$287
24" x 66"	TZ2466	\$318
24" x 72"	TZ2472	\$345
30" x 36"	TZ3036	\$217
30" x 42"	TZ3042	\$253
30" x 48"	TZ3048	\$287
30" x 54"	TZ3054	\$325
30" x 60"	TZ3060	\$359
30" x 66"	TZ3066	\$395
30" x 72"	TZ3072	\$430

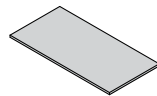

### 3. Top Finish

Laminate	Code	Price
Ankara Cherry	TL18	+ \$0
Black	TL19	+ \$0
Brazilian Walnut	TL20	+ \$0
Cabinet Maple	TL21	+ \$0
Driftwood	TL23	+ \$0
Folkstone Grey	TL24	+ \$0
Libretti	TL25	+ \$0
Queenston Oak	TL26	+ \$0
Sandalwood	TL27	+ \$0
Walnut Amati	TL28	+ \$0
White	TL29	+ \$0

### 4. Grommets

Grommet Location	Code	Price
None	GP00	+ \$0
Left Only	GP01	+ \$30
Center Only	GP02	+ \$30
Right Only	GP03	+ \$30
Left and Center	GP04	+ \$60
Left and Right	GP05	+ \$60
Right and Center	GP06	+ \$60
Left, Right and Center	GP07	+ \$90

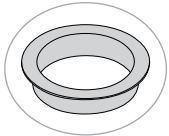

Grommet Color	Code	Price
Black	GC01	+ \$0
White	GC02	+ \$0

### SPECIFICATIONS

	Tensor Multipurpose
Height	29.67"
Leg Width	1.8"
Tabletop Thickness	1.125"
Weight Capacity Warranty	300 lb

Height range includes 1.125" tabletop.

### 1. Product

Product Type	Code	Price
Table Base	3232 TBT9	\$469

### 2. Size

Tabletop Size (D x W)	Code	Price
18" x 42"	TZ1842	+ \$0
18" x 48"	TZ1848	+ \$40
18" x 54"	TZ1854	+ \$40
18" x 60"	TZ1860	+ \$40
18" x 66"	TZ1866	+ \$40
18" x 72"	TZ1872	+ \$64
24" x 36"	TZ2436	+ \$0
24" x 42"	TZ2442	+ \$0
24" x 48"	TZ2448	+ \$40
24" x 54"	TZ2454	+ \$40
24" x 60"	TZ2460	+ \$40
24" x 66"	TZ2466	+ \$40
24" x 72"	TZ2472	+ \$64
30" x 36"	TZ3036	+ \$0
30" x 42"	TZ3042	+ \$0
30" x 48"	TZ3048	+ \$40
30" x 54"	TZ3054	+ \$40
30" x 60"	TZ3060	+ \$40
30" x 66"	TZ3066	+ \$40
30" x 72"	TZ3072	+ \$64



Table bases require the specification of a tabletop size. Bases take their size from their corresponding top size.

### 3. Base Finish

Paint Color	Code	Price
Silver	BF01	+ \$0
White	BF02	+ \$0
Black	BF03	+ \$0

### 1. Additional Options (Sold Separately)

Ganging	Code	Price
Pair of Ganging Brackets	3159 XGV	\$43

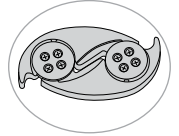

# Tensor

## DESKING

### *One table does it all.*

As your business grows and changes, your workspace should be able to keep up. That's why we created Tensor—one table that can adapt to your changing needs. It's the only table that can expand to support multiple top shapes and sizes with a single base. This allows you to install and reconfigure to fit any space quickly and easily.



**EFFECTIVE DECEMBER 1, 2021**

### Featured Models

#### **L-SHAPE DESK :: \$1,449**

30" x 72" rectangular desktop, 24" x 48" return top, no grommets, matching bases

#### **U-SHAPE DESK :: \$2,212**

30" x 72" desktop, 24" x 72" credenza tops, no grommets, 24" x 42" bridgetop, matching bases and bridge support

## Features

- Patent-pending easy-to-size table support structure adapts to all spaces
- Steel dual-isosceles triangle design evenly distributes and supports weight throughout
- Accommodates desktops from 24" x 54"-30" x 72"; credenzas from 18" x 54"-30" x 72"; 24" x 36"-60"
- Features a minimalistic aesthetic with a below-the-surface configuration
- 11 different durable laminate options to fit your style
- Installs in less than 10 minutes with pre-installed parts
- 300 lb weight capacity warranty

## SPECIFICATIONS

	Tensor Desking
Height	29.67"
Leg Width	1.8"
Tabletop Thickness	1.125"
Weight Capacity Warranty	300 lb

*Height range includes 1.125" tabletop.*



*U-Shape Desk*  
 Chair sold separately;  
 see page 112 for Novo.

## DESKTOP AND DESK BASE FOR L-SHAPE OR U-SHAPE

TOPS AND BASES ARE SPECIFIED AND SOLD SEPARATELY.

### 1. Product

Product Type	Code	Price
Desktop	3231 TBT9	Priced by Size

### 2. Size

Desktop Size (D x W)	Code	Price
24" x 54"	TZ2454	\$259
24" x 60"	TZ2460	\$287
24" x 66"	TZ2466	\$318
24" x 72"	TZ2472	\$345
30" x 54"	TZ3054	\$325
30" x 60"	TZ3060	\$359
30" x 66"	TZ3066	\$395
30" x 72"	TZ3072	\$430

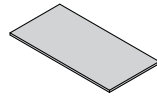

### 3. Top Finish

Laminate	Code	Price
Ankara Cherry	TL18	+ \$0
Black	TL19	+ \$0
Brazilian Walnut	TL20	+ \$0
Cabinet Maple	TL21	+ \$0
Driftwood	TL23	+ \$0
Folkstone Grey	TL24	+ \$0
Libretti	TL25	+ \$0
Queenston Oak	TL26	+ \$0
Sandalwood	TL27	+ \$0
Walnut Amati	TL28	+ \$0
White	TL29	+ \$0

### 4. Grommets

Grommet Location	Code	Price
None	GP00	+ \$0
Left Only	GP01	+ \$30
Center Only	GP02	+ \$30
Right Only	GP03	+ \$30
Left and Center	GP04	+ \$60
Left and Right	GP05	+ \$60
Right and Center	GP06	+ \$60
Left, Right and Center	GP07	+ \$90

Grommet Color	Code	Price
Black	GC01	+ \$0
White	GC02	+ \$0

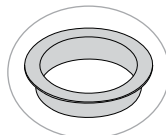

### 1. Desk Base

Product Type	Code	Price
Base	3232 TBT9	\$469

### 2. Size

Desktop Size (D x W)	Code	Price
24" x 54"	TZ2454	+ \$40
24" x 60"	TZ2460	+ \$40
24" x 66"	TZ2466	+ \$40
24" x 72"	TZ2472	+ \$64
30" x 54"	TZ3054	+ \$40
30" x 60"	TZ3060	+ \$40
30" x 66"	TZ3066	+ \$40
30" x 72"	TZ3072	+ \$64



Desk bases require the specification of a desktop size. Bases take their size from their corresponding top size.

### 3. Base Finish

Paint Color	Code	Price
Silver	BF01	+ \$0
White	BF02	+ \$0
Black	BF03	+ \$0

## 1. Product

Product Type	Code	Size
Return Top	3231 TBT9P	Priced by Size

## 2. Size

Return Top Size (D x W)	Code	Price
24" x 36"	TN2436	\$174
24" x 42"	TN2442	\$203
24" x 48"	TN2448	\$231
24" x 54"	TN2454	\$259
24" x 60"	TN2460	\$287

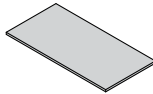

## 3. Top Finish

Laminate	Code	Price
Ankara Cherry	TL18	+ \$0
Black	TL19	+ \$0
Brazilian Walnut	TL20	+ \$0
Cabinet Maple	TL21	+ \$0
Driftwood	TL23	+ \$0
Folkstone Grey	TL24	+ \$0
Libretti	TL25	+ \$0
Queenston Oak	TL26	+ \$0
Sandalwood	TL27	+ \$0
Walnut Amati	TL28	+ \$0
White	TL29	+ \$0

## 4. Grommets

Grommet Location	Code	Price
None	GPR00	+ \$0
Left Only	GPR01	+ \$30
Center Only	GPR02	+ \$30
Right Only	GPR03	+ \$30

Grommet Color	Code	Price
Black	GC01	+ \$0
White	GC02	+ \$0

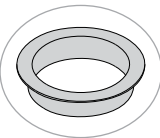

## RETURN TOP AND RETURN BASE FOR L-SHAPE OR U-SHAPE

TOPS AND BASES ARE SPECIFIED AND SOLD SEPARATELY.

## 1. Product

Product Type	Code	Price
Return Base	3232 TBT9P	\$255

## 2. Size

Return Top Size (D x W)	Code	Price
No Return Top	TN0	+ \$0
24" x 36"	TN2436	+ \$0
24" x 42"	TN2442	+ \$0
24" x 48"	TN2448	+ \$0
24" x 54"	TN2454	+ \$74
24" x 60"	TN2460	+ \$74

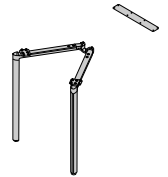

Return bases require the specification of a return top size.

## 3. Base Finish

Paint Color	Code	Price
Silver	BF01	\$0
White	BF02	\$0
Black	BF03	\$0

## 1. Product

Product Type	Code	Price
Bridgetop	3231 TBT10	Priced by Size

## 2. Size

Bridgetop Size (D x W)	Code	Price
24" x 36"	TZ2436	\$174
24" x 42"	TZ2442	\$203
24" x 48"	TZ2448	\$231
24" x 54"	TZ2454	\$259
24" x 60"	TZ2460	\$287

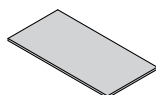

## 3. Top Finish

Laminate	Code	Price
Ankara Cherry	TL18	+ \$0
Black	TL19	+ \$0
Brazilian Walnut	TL20	+ \$0
Cabinet Maple	TL21	+ \$0
Driftwood	TL23	+ \$0
Folkstone Grey	TL24	+ \$0
Libretti	TL25	+ \$0
Queenston Oak	TL26	+ \$0
Sandalwood	TL27	+ \$0
Walnut Amati	TL28	+ \$0
White	TL29	+ \$0

## BRIDGETOP AND SUPPORT FOR U-SHAPE TOPS AND BASES ARE SPECIFIED AND SOLD SEPARATELY.

## 1. Product

Product Type	Code	Price
Bridge Support (Mending Brackets)	3232 TBT10	Priced by Size

## 2. Size

Bridgetop Size (D x W)	Code	Price
No Bridge Top	TN0	+ \$0
24" x 36"	TZ2436	+ \$168
24" x 42"	TZ2442	+ \$168
24" x 48"	TZ2448	+ \$168
24" x 54"	TZ2454	+ \$258
24" x 60"	TZ2460	+ \$258

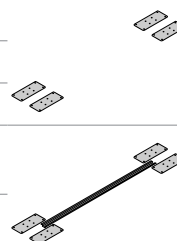

Support includes two sets of mending brackets for all bridge sizes. 54" and 60" table widths also include stiffener.

Bridge supports require the specification of a bridge top size.

## CREDENZA TOP FOR U-SHAPE

TOPS AND BASES ARE SPECIFIED AND SOLD SEPARATELY.

### 1. Product

Product Type	Code	Price	
Credenza Top	3231 TBT9	Priced by Size	

### 2. Size

Credenza Top Size (D x W)	Code	Price	
18" x 54"	TZ1854	\$200	
18" x 60"	TZ1860	\$220	
18" x 66"	TZ1866	\$244	
18" x 72"	TZ1872	\$266	
24" x 54"	TZ2454	\$259	
24" x 60"	TZ2460	\$287	
24" x 66"	TZ2466	\$318	
24" x 72"	TZ2472	\$345	
30" x 54"	TZ3054	\$325	
30" x 60"	TZ3060	\$359	
30" x 66"	TZ3066	\$395	
30" x 72"	TZ3072	\$430	

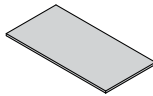

### 4. Grommets

Grommet Location	Code	Price	
No Grommets	GP00	+ \$0	
Left Only	GP01	+ \$30	
Center Only	GP02	+ \$30	
Right Only	GP03	+ \$30	
Left and Center	GP04	+ \$60	
Left and Right	GP05	+ \$60	
Right and Center	GP06	+ \$60	
Left, Right and Center	GP07	+ \$90	

Grommet Color	Code	Price	
Black	GC01	+ \$0	
White	GC02	+ \$0	

### 3. Top Finish

Laminate	Code	Price	
Ankara Cherry	TL18	+ \$0	
Black	TL19	+ \$0	
Brazilian Walnut	TL20	+ \$0	
Cabinet Maple	TL21	+ \$0	
Driftwood	TL23	+ \$0	
Folkstone Grey	TL24	+ \$0	
Libretti	TL25	+ \$0	
Queenston Oak	TL26	+ \$0	
Sandalwood	TL27	+ \$0	
Walnut Amati	TL28	+ \$0	
White	TL29	+ \$0	



### 1. Product

Product Type	Code	Price
Credenza Base	3232 TBT9	\$469

### 2. Size

Credenza Top Size (D x W)	Code	Price
18" x 54"	TZ1854	+ \$40
18" x 60"	TZ1860	+ \$40
18" x 66"	TZ1866	+ \$40
18" x 72"	TZ1872	+ \$64
24" x 54"	TZ2454	+ \$40
24" x 60"	TZ2460	+ \$40
24" x 66"	TZ2466	+ \$40
24" x 72"	TZ2472	+ \$64
30" x 54"	TZ3054	+ \$40
30" x 60"	TZ3060	+ \$40
30" x 66"	TZ3066	+ \$40
30" x 72"	TZ3072	+ \$64

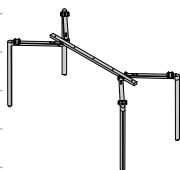

*Credenza bases require the specification of a credenza top size. Bases take their size from their corresponding top size.*

### 3. Base Finish

Paint Color	Code	Price
Silver	BF01	+ \$0
White	BF02	+ \$0
Black	BF03	+ \$0

# Uni

## LAPTOP TABLE

### *Uni-quely Uni-versal.*

Light in weight and not on convenience. Uni goes anywhere you need it—and with any lounge collection we have. Laptops, notebooks, coffee mugs and more, it's the perfect seating sidekick for your shared and in-between spaces.



**EFFECTIVE DECEMBER 1, 2021**

### Featured Models

**CHARCOAL :: \$459**

Rectangular laptop table, charcoal base, laminate top

**SILVER :: \$459**

Rectangular laptop table, charcoal base, laminate top

## LAPTOP TABLE

## Features

- Ample surface provides plenty of room to work
- Sleek laminate top features a low-profile knife edge
- Easy-grip finger groove makes moving easy
- Durable base is ultra slim for safer high-traffic areas
- Multi-surface glides enhance mobility while protecting floors
- 100 lb weight capacity warranty

### 1. Product

Model	Code	Price	
Rectangular Laptop Table	3260 TT9	\$459	

### 2. Base

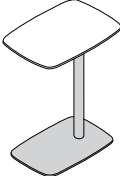
Base Color	Code	Price	
Charcoal	BF04	+\$0	
Silver	BF01	+\$0	

### 3. Table Top

Material	Code	Price	
Laminate	TM3	+\$0	
Field Elm	TL13	+\$0	
Uptown Walnut	TL14	+\$0	
Skyline Walnut	TL15	+\$0	
Frosty White	TL16	+\$0	

### 4. Packaging

Packaging	Code	Price	
Final Assembly Required	P3	+\$0	

### SPECIFICATIONS

Model:	3260 TT9 Laptop Table
<b>Dimensions</b>	
Overall Height	25.5"
Tabletop Depth	14"
Tabletop Width	20"
Tabletop Thickness	0.75"
Base Depth	11.6"
Base Width	17.6"
Base Thickness	0.25"
<b>Weight and Capacity</b>	
Weight	23.63 lb
Weight Capacity Warranty	100 lb



Charcoal

# Benching

FIXED | SINGLE-SIDED | BACK-TO-BACK

# Prise

## BENCHING TYPICALS

One size really does fit all. Prise is the go-to solution for modular benching, allowing you to build and arrange to fit your workspace. Keep cords, electronics and more all together with standard integrated power trays and slide-out tabletops.



Private Office



Conference



Side-by-Side



Three-Seat



Three-Seat With Screens



Three-Seat With Returns



Six-Seat With Screens



Six-Seat With Returns

EFFECTIVE DECEMBER 1, 2021

**1. Side-by-Side Typical**

Category	Code	Quantity	Description	List Price	Ext. Price	
Bench Top	3021 SS SP2 TZ2472 TL27 GP05 GC02	1	Set of Two Bench Tops: 24" x 72", Laminate, Left and Right Grommets	\$810	\$810	
Bench Base	3022 SS SP2 TZ2472 PIW	1	2-Seat Base: Single-Sided, 8-Wire Wall Infeed (Pairs With 24" x 72" Bench Top)	\$2,411	\$2,411	
Modesty Screen	3093 MT8 DT501 MPC27 DS1066	2	Modesty Screen: 10" x 66", Laminate	\$297	\$594	
Wire Management	3152 WM05	2	Wire Basket Without Power	\$85	\$170	

**TOTAL: \$3,985**

**2. Private Office Typical**

Category	Code	Quantity	Description	List Price	Ext. Price	
Bench Top	3021 SS SP1 TZ3072 TL27 GP00	1	Bench Top: 30" x 72", Laminate, No Grommets	\$430	\$430	
Tabletop	3000 TZ2448 TL27 GP00 TTMP1 STF00	1	Rectangular Tabletop: 24" x 48" Laminate, Mending Plate Kit, No Stiffner, No Grommets	\$305	\$305	
Tabletop	3000 TZ2472 TL27 GP00 TTMP1 STF00	1	Rectangular Tabletop: 24" x 72", Laminate, Mending Plate Kit, No Stiffner, No Grommets	\$419	\$419	
Bench Base	3022 SS SP1 TZ3072 NPOW	1	1-Seat Base: Single-Sided, No Power (Pairs With 30" x 72" Bench Top)	\$898	\$898	
Bench Base	3022 SS SP1 TZ2472 NPOW	1	1-Seat Base: Single-Sided, No Power (Pairs With 24" x 72" Tabletop)	\$898	\$898	
Modesty Screen	3093 MT8 DT501 MPC27 DS1066	1	Modesty Screen: 10" x 66", Laminate	\$297	\$297	
Storage	3150 CPT01 PDC02	1	Mobile Pedestal With Upholstered Cushion, Grade 1 Textile	\$446	\$446	

See page 533 to order tabletops.

**TOTAL: \$3,693**

EFFECTIVE DECEMBER 1, 2021

**3. Conference Typical**

Category	Code	Quantity	Description	List Price	Ext. Price
Tabletop	3000 TZ4896 TL27 GP00 TTMP0 STF00	1	Rectangular Tabletop: 48" x 96", Laminate, No Grommets, No Stiffner	\$914	\$914
Bench Base	3022 BB SP2 TZ3066 NPOW	1	2-Seat Base: Back-to-Back, No Power	\$1,412	\$1,412

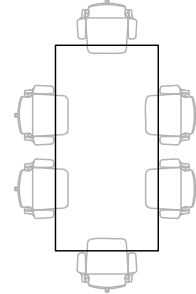

See page 533 to order oversized tabletops.

**TOTAL: \$2,326**

**4. Three Seat Typical**

Category	Code	Quantity	Description	List Price	Ext. Price
Bench Top	3021 SS SP3 TZ3060 TL27 GP05 GC02	1	Set of Three Bench Tops: 30" x 60", Laminate, Grommets on the Left and Right	\$1,257	\$1,257
Bench Base	3022 SS SP3 TZ3060 PIW	1	3-Seat Base: Single-Sided, 8-Wire Wall Infeed (Pairs With 30" x 60" Bench Top)	\$3,508	\$3,508
Modesty Screen	3093 MT8 DT501 MPC27 DS1054	3	Modesty Screen: 10" x 54", Laminate	\$254	\$762
Storage	3150 CPT01 PDC02	3	Mobile Pedestal With Upholstered Cushion, Grade 1 Textile	\$446	\$1,338
Wire Management	3152 WM05	3	Wire Basket Without Power	\$85	\$255

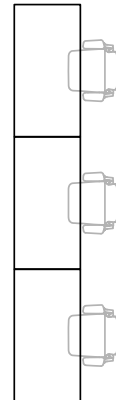

**TOTAL: \$7,120**

**5. Three Seat Typical With Screens**

Category	Code	Quantity	Description	List Price	Ext. Price
Bench Top	3021 SS SP3 TZ3060 TL27 GP05 GC02	1	Set of Three Bench Tops: 30" x 60", Laminate, Left and Right Grommets	\$1,257	\$1,257
Base	3022 SS SP3 TZ3060 PIW	1	3-Seat Base: Single Sided, 8-Wire Wall Infeed (Pairs With 30" x 60" Top)	\$3,508	\$3,508
Screen	3090 MT5 DT701 DS3060	3	30" x 60" Screen, Fabric, Grade 1 Textile, Midway Mounts	\$702	\$2,106
Storage	3150 CPT01 PDC02	3	Mobile Pedestal With Upholstered Cushion, Grade 1 Textile	\$446	\$1,338
Wire Management	3152 WM05	3	Wire Basket Without Power	\$85	\$255

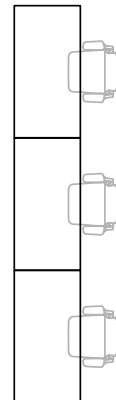

See the screens section starting page page 480 for midway mounts and other screen options

**TOTAL: \$8,464**

EFFECTIVE DECEMBER 1, 2021

**6. Three-Seat Typical With Returns**

Category	Code	Quantity	Description	List Price	Ext. Price
Bench Top	3021 SS SP3 TZ3072 TL27 GP05 GC02	1	Set of Three Bench Tops: 30" x 72", Laminate, Left and Right Grommets	\$1,470	\$1,470
Return Top	3024 SS SP3 RP3 TN2448 TL27 GPR00	1	Set of Three Returntops: 24" x 48", Laminate, No Grommets	\$693	\$693
Bench Base	3022 SS SP3 TZ3072 PIW	1	3-Seat Base: Single-Sided, 8-Wire Wall Infeed (Pairs With 30" x 72" Bench Tops)	\$3,508	\$3,508
Return Base	3025 SS SP3 RP3 TN2448	1	Set of Three Return Bases: Single-Sided (Pairs With 24" x 48" Returntops)	\$1,464	\$1,464
Modesty Screen	3093 MT8 DT501 MPC27 DS1066	3	Modesty Screen: 10" x 66", Laminate	\$297	\$891
Storage	3150 CPT01 PDC02	3	Mobile Pedestal With Upholstered Cushion, Grade 1 Textile	\$446	\$1,338
Wire Management	3152 WM05	3	Wire Basket Without Power	\$85	\$255

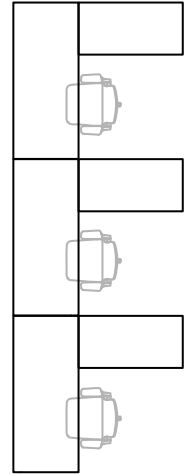

**TOTAL: \$9,619**

**7. Six-Seat Typical With Screens**

Category	Code	Quantity	Description	List Price	Ext. Price
Bench Top	3021 BB SP6 TZ3060 TL27 GP05 GC02	1	Set of Six Bench Tops: 30" x 60", Laminate, Left and Right Grommets	\$2,514	\$2,514
Bench Base	3022 BB SP6 TZ3060 PIW	1	6-Seat Base: Back-to-Back, 8-Wire Wall Infeed (Pairs With 30" x 60" Bench Tops)	\$5,298	\$5,298
Screen	3023 BB SP6 TZ3060 DT701 DS1860	1	Set of Three Screens: 18" x 60", Prise Mounts, Fabric, Grade 1 Textile	\$1,314	\$1,314
Storage	3150 CPT01 PDC02	6	Mobile Pedestal With Upholstered Cushion, Grade 1 Textile	\$446	\$2,676

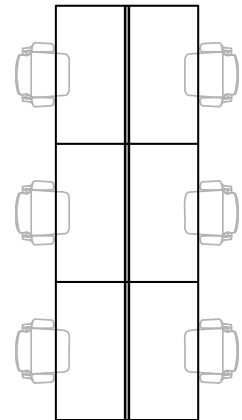

**TOTAL: \$11,802**



EFFECTIVE DECEMBER 1, 2021

**8. Six-Seat Typical With Returns**

Category	Code	Quantity	Description	List Price	Ext. Price	
Bench Top	3021 BB SP6 TZ3072 TL27 GP05 GC02	1	Set of Six Bench Tops: 30" x 72", Laminate, Left and Right Grommets	\$2,940	\$2,940	
Returntop	3024 BB SP6 RP6 TN2448 TL27 GPR00	1	Set of Six Returntops: 24" x 48", Laminate, No Grommets.	\$1,386	\$1,386	
Bench Base	3022 BB SP6 TZ3072 PIW	1	6-Seat Base: Back-to-Back, 8-Wire Wall Infeed (Pairs With 30" x 72" Bench Tops)	\$5,298	\$5,298	
Return Base	3025 BB SP6 RP6 TN2448	1	Set of Six Return Bases (Pair With 24" x 48" Returntops)	\$2,928	\$2,928	
Screen	3023 BB SP6 TZ3072 DT701 DS1872	1	Set of Three Screens: 18" x 72", Prise Mounts, Fabric, Grade 1 Textile	\$1,479	\$1,479	
Storage	3150 CPT01 PDC02	6	Mobile Pedestal With Upholstered Cushion, Grade 1 Textile	\$446	\$2,676	
				<b>TOTAL:</b>	<b>\$16,707</b>	

# Prise

## BENCHING

One size really does fit all. Prise is the go-to solution for modular benching, allowing you to build and arrange to fit your workspace. Keep cords, electronics and more all together with standard integrated power trays and slide-out tabletops.



6-Seat

*Chairs not included; see page 123 for Novo.  
Storage not included; see page 525 for mobile pedestals.*

**EFFECTIVE DECEMBER 1, 2021**

### Featured Models

#### **2-SEAT :: \$3,985**

2-seat, single-sided, 34" x 72" bench tops, 10" x 66" laminate modesty screens, and wire basket wire management

#### **6-SEAT :: \$11,802**

6-seat, back-to-back, 30" x 60" bench tops with grommets on the left and right, 18" x 60" fabric screens, mobile pedestals with upholstered pads

#### **6-SEAT+RETURNS :: \$16,707**

6-seat, back-to-back, 30" x 72" bench tops with grommets on the left and right, 18" x 72" fabric screens, 24" x 48" returns, mobile pedestals with upholstered pads

## Features

- Steel-frame-constructed bench with standard white base
- Mount screens easily with centered built-in extrusion on bench
- Manage wires with standard integrated power trays and slide-out function for tabletops
- Choose from 11 standard laminate tabletop finishes
- Pick grommets from two colors and specify in multiple locations
- Fixed glides are standard on all models
- Four power ports come standard per bench station; data add-on optional when specified with power
- Provide added convenience with a variety of additional wire management and power options







## SPECIFICATIONS

	3021 SS Single-Sided Benching	3021 BB Back-to-Back Benching
Total Depth of Benches	24" 30"	51.44" (24" Top) 63.44" (30" Top)
Space Between Back-to-Back Benches	N/A	3.44"
Gap on Either Side of Center Rail	N/A	1.09"
Bench Top Thickness	1.125"	1.125"
Side-to-Side Gap (Mid Run)	0.125"	0.125"
Height With Bench Top	29.3"	29.3"
Height From Floor to Underside of Base	24.24"	24.24"
Distance Between Legs (Depth) at Base (Inside-Edge-to-Inside-Edge End)	17.52"	40.42"
Distance Between Legs (Depth) at Top	9"	32"
Distance Between Legs at Base (Outside-Edge-to-Outside-Edge)	23.96"	46.85"
Leg Depth	3.17"	3.17"
Leg Width	1.99"	1.99"
Weight Capacity (Per Seat or Return)	200 lb	200 lb

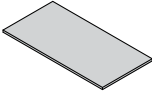
## BENCH TOP

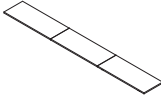
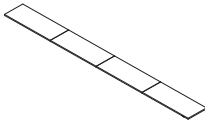
TOPS AND BASES ARE SPECIFIED AND SOLD SEPARATELY.

### 1. Product

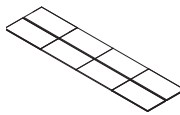
Product Type	Code	Price	
Bench Top	3021	Priced by Size	
Orientation	Code	Price	
Single-Sided	SS	Priced by Size	
Back-to-Back	BB	Priced by Size	
Seated Positions	Code	Price	
Single-Sided			
One Seat	SP1	Priced by Size	
Two Seats	SP2	Priced by Size	
Three Seats	SP3	Priced by Size	
Four Seats	SP4	Priced by Size	
Back-to-Back			
Two Seats	SP2	Priced by Size	
Four Seats	SP4	Priced by Size	
Six Seats	SP6	Priced by Size	
Eight Seats	SP8	Priced by Size	

**2. Size**

Depth x Width	Code	Base Price
<b>One Seat (SS)</b>		
24" x 48"	TZ2448	\$231
24" x 54"	TZ2454	\$259
24" x 60"	TZ2460	\$287
24" x 66"	TZ2466	\$318
24" x 72"	TZ2472	\$345
30" x 48"	TZ3048	\$287
30" x 54"	TZ3054	\$325
30" x 60"	TZ3060	\$359
30" x 66"	TZ3066	\$395
30" x 72"	TZ3072	\$430
<b>Two Seats (SS or BB)</b>		
24" x 48"	TZ2448	\$462
24" x 54"	TZ2454	\$518
24" x 60"	TZ2460	\$574
24" x 66"	TZ2466	\$636
24" x 72"	TZ2472	\$690
30" x 48"	TZ3048	\$574
30" x 54"	TZ3054	\$650
30" x 60"	TZ3060	\$718
30" x 66"	TZ3066	\$790
30" x 72"	TZ3072	\$860
<b>Three Seats (SS)</b>		
24" x 48"	TZ2448	\$693
24" x 54"	TZ2454	\$777
24" x 60"	TZ2460	\$861
24" x 66"	TZ2466	\$954
24" x 72"	TZ2472	\$1,035
30" x 48"	TZ3048	\$861
30" x 54"	TZ3054	\$975
30" x 60"	TZ3060	\$1,077
30" x 66"	TZ3066	\$1,185
30" x 72"	TZ3072	\$1,290

**BENCH TOP**

TOPS AND BASES ARE SPECIFIED AND SOLD SEPARATELY.

**2. Size (Cont.)**

Depth x Width	Code	Base Price
<b>Four Seats (SS or BB)</b>		
24" x 48"	TZ2448	\$924
24" x 54"	TZ2454	\$1,036
24" x 60"	TZ2460	\$1,148
24" x 66"	TZ2466	\$1,272
24" x 72"	TZ2472	\$1,380
30" x 48"	TZ3048	\$1,148
30" x 54"	TZ3054	\$1,300
30" x 60"	TZ3060	\$1,436
30" x 66"	TZ3066	\$1,580
30" x 72"	TZ3072	\$1,720
<b>Six Seats (BB)</b>		
24" x 48"	TZ2448	\$1,386
24" x 54"	TZ2454	\$1,554
24" x 60"	TZ2460	\$1,722
24" x 66"	TZ2466	\$1,908
24" x 72"	TZ2472	\$2,070
30" x 48"	TZ3048	\$1,722
30" x 54"	TZ3054	\$1,950
30" x 60"	TZ3060	\$2,154
30" x 66"	TZ3066	\$2,370
30" x 72"	TZ3072	\$2,580
<b>Eight Seats (BB)</b>		
24" x 48"	TZ2448	\$1,848
24" x 54"	TZ2454	\$2,072
24" x 60"	TZ2460	\$2,296
24" x 66"	TZ2466	\$2,544
24" x 72"	TZ2472	\$2,760
30" x 48"	TZ3048	\$2,296
30" x 54"	TZ3054	\$2,600
30" x 60"	TZ3060	\$2,872
30" x 66"	TZ3066	\$3,160
30" x 72"	TZ3072	\$3,440

**3. Top Finish**

Laminate	Code	Price
Ankara Cherry	TL18	+ \$0
Black	TL19	+ \$0
Brazilian Walnut	TL20	+ \$0
Cabinet Maple	TL21	+ \$0
Driftwood	TL23	+ \$0
Folkstone Grey	TL24	+ \$0
Libretti	TL25	+ \$0
Queenston Oak	TL26	+ \$0
Sandalwood	TL27	+ \$0
Walnut Amati	TL28	+ \$0
White	TL29	+ \$0

**BENCH TOP**







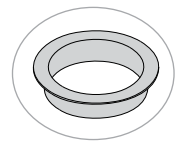

TOPS AND BASES ARE SPECIFIED AND SOLD SEPARATELY.

**4. Grommets**

Grommet Location	Code	Price
None	GP00	+ \$0
<b>One Seat (SS)</b>		
Left	GP01	+ \$30
Right	GP03	+ \$30
Left and Right	GP05	+ \$60
<b>Two Seats (SS or BB)</b>		
Left	GP01	+ \$60
Right	GP03	+ \$60
Left and Right	GP05	+ \$120
<b>Three Seats (SS)</b>		
Left	GP01	+ \$90
Right	GP03	+ \$90
Left and Right	GP05	+ \$180
<b>Four Seats (SS or BB)</b>		
Left	GP01	+ \$120
Right	GP03	+ \$120
Left and Right	GP05	+ \$240
<b>Six Seats (BB)</b>		
Left	GP01	+ \$180
Right	GP03	+ \$180
Left and Right	GP05	+ \$360
<b>Eight Seats (BB)</b>		
Left	GP01	+ \$240
Right	GP03	+ \$240
Left and Right	GP05	+ \$480
Grommet Color	Code	Price
Black	GC01	+ \$0
White	GC02	+ \$0



## 1. Product

Product Type	Code	Price	
Bench Bases	3022	Priced by Seated Positions	
Orientation	Code	Price	
Single-Sided	SS	Priced by Seated Positions	
Back-to-Back	BB	Priced by Seated Positions	
Seated Postions	Code	Price	
Single-Sided			
1-Seat	SP1	\$898	
2-Seat	SP2	\$1,598	
3-Seat	SP3	\$2,297	
4- Seat	SP4	\$2,996	
Back-to-Back			
2-Seat	SP2	\$1,412	
4-Seat	SP4	\$2,421	
6-Seat	SP6	\$3,431	
8-Seat	SP8	\$4,442	

## BENCH BASE

TOPS AND BASES ARE SPECIFIED AND SOLD SEPARATELY.

## 2. Size

Top Size	Code	Price	
No Top	TZ0	+ \$0	
24" x 48"	TZ2448	+ \$0	
24" x 54"	TZ2454	+ \$0	
24" x 60"	TZ2460	+ \$0	
24" x 66"	TZ2466	+ \$0	
24" x 72"	TZ2472	+ \$0	
30" x 48"	TZ3048	+ \$0	
30" x 54"	TZ3054	+ \$0	
30" x 60"	TZ3060	+ \$0	
30" x 66"	TZ3066	+ \$0	
30" x 72"	TZ3072	+ \$0	

Bench bases require the specification of a bench top size. Bases take their size from their corresponding top size.

## 3. Power

Power Type	Code	Price	
No Power Pack	NPOW	+ \$0	
Single-Sided, 8-Wire Wall Infeed			
One Seat	PIW	\$415	
Two Seats	PIW	\$813	
Three Seats	PIW	\$1,211	
Four Seats	PIW	\$1,610	
Single-Sided, 8-Wire Ceiling Infeed			
One Seat	PIC	\$441	
Two Seats	PIC	\$840	
Three Seats	PIC	\$1,241	
Four Seats	PIC	\$1,638	
Back-to-Back, 8-Wire Wall Infeed			
Two Seats	PIW	\$632	
Four Seats	PIW	\$1,249	
Six Seats	PIW	\$1,867	
Eight Seats	PIW	\$2,484	
Back-to-Back, 8-Wire Ceiling Infeed			
Two Seats	PIC	\$662	
Four Seats	PIC	\$1,278	
Six Seats	PIC	\$1,895	
Eight Seats	PIC	\$2,513	

Infeeds come standard with one dual outlet power module per seat.

**1. Returntop**

Product Type	Code	Price	
--------------	------	-------	--

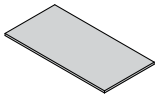
Returntop	3024	Priced by Size	
-----------	------	----------------	---

Orientation	Code	Price	
-------------	------	-------	--

Single-Sided	SS	Priced by Size	
Back-to-Back	BB	Priced by Size	

Seated Postions	Code	Price	
-----------------	------	-------	--

<b>Single-Sided</b>			
One Seat	SP1	Priced by Size	
Two Seats	SP2	Priced by Size	
Three Seats	SP3	Priced by Size	
Four Seats	SP4	Priced by Size	

<b>Back-to-Back</b>			
---------------------	--	--	--

Two Seats	SP2	Priced by Size	
Four Seats	SP4	Priced by Size	
Six Seats	SP6	Priced by Size	
Eight Seats	SP8	Priced by Size	

Return Quantity	Code	Price	
-----------------	------	-------	--

One	RP1	Priced by Size	
Two	RP2	Priced by Size	
Three	RP3	Priced by Size	
Four	RP4	Priced by Size	
Five	RP5	Priced by Size	
Six	RP6	Priced by Size	
Seven	RP7	Priced by Size	
Eight	RP8	Priced by Size	

**2. Size**

Returntop Size (D x W)	Code	Price	
------------------------	------	-------	--

<b>One</b>			
24" x 36"	TN2436	\$174	
24" x 42"	TN2442	\$203	
24" x 48"	TN2448	\$231	
30" x 30"	TN3030	\$181	
30" x 36"	TN3036	\$217	
30" x 42"	TN3042	\$253	

**RETURNTOP**

TOPS AND BASES ARE SPECIFIED AND SOLD SEPARATELY.

**2. Size (Cont.)**

Returntop Size (D x W)	Code	Price	
------------------------	------	-------	--

<b>Two</b>			
------------	--	--	--

24" x 36"	TN2436	\$348	
24" x 42"	TN2442	\$406	
24" x 48"	TN2448	\$462	
30" x 30"	TN3030	\$362	
30" x 36"	TN3036	\$434	
30" x 42"	TN3042	\$506	

<b>Three</b>			
--------------	--	--	--

24" x 36"	TN2436	\$522	
24" x 42"	TN2442	\$609	
24" x 48"	TN2448	\$693	
30" x 30"	TN3030	\$543	
30" x 36"	TN3036	\$651	
30" x 42"	TN3042	\$759	

<b>Four</b>			
-------------	--	--	--

24" x 36"	TN2436	\$696	
24" x 42"	TN2442	\$812	
24" x 48"	TN2448	\$924	
30" x 30"	TN3030	\$724	
30" x 36"	TN3036	\$868	
30" x 42"	TN3042	\$1,012	

<b>Five</b>			
-------------	--	--	--

24" x 36"	TN2436	\$870	
24" x 42"	TN2442	\$1,015	
24" x 48"	TN2448	\$1,155	
30" x 30"	TN3030	\$905	
30" x 36"	TN3036	\$1,085	
30" x 42"	TN3042	\$1,265	

<b>Six</b>			
------------	--	--	--

24" x 36"	TN2436	\$1,044	
24" x 42"	TN2442	\$1,218	
24" x 48"	TN2448	\$1,386	
30" x 30"	TN3030	\$1,086	
30" x 36"	TN3036	\$1,302	
30" x 42"	TN3042	\$1,518	

**2. Size (Cont.)**

Returntop Size (D x W)	Code	Price	
<b>Seven</b>			
24" x 36"	TN2436	\$1,218	
24" x 42"	TN2442	\$1,421	
24" x 48"	TN2448	\$1,617	
30" x 30"	TN3030	\$1,267	
30" x 36"	TN3036	\$1,519	
30" x 42"	TN3042	\$1,771	
<b>Eight</b>			
24" x 36"	TN2436	\$1,392	
24" x 42"	TN2442	\$1,624	
24" x 48"	TN2448	\$1,848	
30" x 30"	TN3030	\$1,448	
30" x 36"	TN3036	\$1,736	
30" x 42"	TN3042	\$2,024	

**3. Top Finish**

Laminate	Code	Price	
Ankara Cherry	TL18	+ \$0	
Black	TL19	+ \$0	
Brazilian Walnut	TL20	+ \$0	
Cabinet Maple	TL21	+ \$0	
Contour White	TL22	+ \$0	
Driftwood	TL23	+ \$0	
Folkstone Grey	TL24	+ \$0	
Libretti	TL25	+ \$0	
Queenston Oak	TL26	+ \$0	
Sandalwood	TL27	+ \$0	
Walnut Amati	TL28	+ \$0	
White	TL29	+ \$0	

**RETURNTOP**

TOPS AND BASES ARE SPECIFIED AND SOLD SEPARATELY.

**4. Grommets**

Grommet Location	Code	Price	
None	GPR00	+ \$0	
<b>One Seat</b>			
Left	GPR01	+ \$30	
Right	GPR03	+ \$30	
Left and Right	GPR05	+ \$60	
<b>Two Seats</b>			
Left	GPR01	+ \$60	
Right	GPR03	+ \$60	
Left and Right	GPR05	+ \$120	
<b>Three Seats</b>			
Left	GPR01	+ \$90	
Right	GPR03	+ \$90	
Left and Right	GPR05	+ \$180	
<b>Four Seats</b>			
Left	GPR01	+ \$120	
Right	GPR03	+ \$120	
Left and Right	GPR05	+ \$240	
<b>Five Seats</b>			
Left	GPR01	+ \$150	
Right	GPR03	+ \$150	
Left and Right	GPR05	+ \$300	
<b>Six Seats</b>			
Left	GPR01	+ \$180	
Right	GPR03	+ \$180	
Left and Right	GPR05	+ \$360	
<b>Seven Seats</b>			
Left	GPR01	+ \$210	
Right	GPR03	+ \$210	
Left and Right	GPR05	+ \$420	
<b>Eight Seats</b>			
Left	GPR01	+ \$240	
Right	GPR03	+ \$240	
Left and Right	GPR05	+ \$480	
Grommet Color	Code	Price	
Black	GC01	+ \$0	
White	GC02	+ \$0	

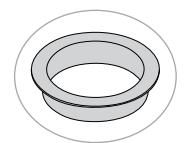

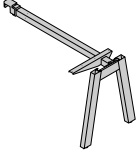

## 1. Product

Product Type	Code	Price	
Return Base	3025	Priced by Quantity	

Orientation	Code	Price	
Single-Sided	SS	Priced by Quantity	
Back-to-Back	BB	Priced by Quantity	

Seated Postions	Code	Price	
<b>Single-Sided</b>			
One Seat	SP1	Priced by Quantity	
Two Seats	SP2	Priced by Quantity	
Three Seats	SP3	Priced by Quantity	
Four Seats	SP4	Priced by Quantity	

<b>Back-to-Back</b>			
Two Seats	SP2	Priced by Quantity	
Four Seats	SP4	Priced by Quantity	
Six Seats	SP6	Priced by Quantity	
Eight Seats	SP8	Priced By Quantity	

Return Quantity	Code	Price	
One	RP1	\$488	
Two	RP2	\$976	
Three	RP3	\$1,464	
Four	RP4	\$1,952	
Five	RP5	\$2,440	
Six	RP6	\$2,928	
Seven	RP7	\$3,416	
Eight	RP8	\$3,904	

Number of returns cannot exceed the number of seats.

## RETURN BASE

TOPS AND BASES ARE SPECIFIED AND SOLD SEPARATELY.

## 2. Size

Returntop Size (D x W)	Code	Price	
No Return	TN0	+ \$0	
24" x 36"	TN2436	+ \$0	
24" x 42"	TN2442	+ \$0	
24" x 48"	TN2448	+ \$0	
30" x 30"	TN3030	+ \$0	
30" x 36"	TN3036	+ \$0	
30" x 42"	TN3042	+ \$0	

Return bases require the specification of a returntop size. Bases take their size from their corresponding top size.

### 1. Product

Product Type	Code	Price
Screen	3023	Priced By Screen Size

### 2. Matching Benching

Orientation	Code	Price
Single-Sided	SS	Priced By Screen Size
Back-to-Back	BB	Priced By Screen Size

Seated Positions	Code	Price
<b>Single-Sided</b>		
One Seat	SP1	Priced By Screen Size
Two Seats	SP2	Priced By Screen Size
Three Seats	SP3	Priced By Screen Size
Four Seats	SP4	Priced By Screen Size

<b>Back-to-Back</b>		
Two Seats	SP2	Priced by Screen Size
Four Seats	SP4	Priced by Screen Size
Six Seats	SP6	Priced by Screen Size
Eight Seats	SP8	Priced by Screen Size

Bench Top Size	Code	Price
None	TZ0	Priced by Screen Size
24" x 48"	TZ2448	Priced by Screen Size
24" x 54"	TZ2454	Priced by Screen Size
24" x 60"	TZ2460	Priced by Screen Size
24" x 66"	TZ2466	Priced by Screen Size
24" x 72"	TZ2472	Priced by Screen Size
30" x 48"	TZ3048	Priced by Screen Size
30" x 54"	TZ3054	Priced by Screen Size
30" x 60"	TZ3060	Priced by Screen Size
30" x 66"	TZ3066	Priced by Screen Size
30" x 72"	TZ3072	Priced by Screen Size

Single-sided orientation comes standard with edge mounts. Back-to-back orientation includes the cost of Prize-specific screen mounts.

Screens require the specification of a bench top size. Screen length may not exceed bench top length.

### 3. Material

Screen Material	Code	Price
Frosted Acrylic	DT101	Priced by Screen Size
Fabric	DT701	Priced by Screen Size
Markerboard	DT301	Priced by Screen Size

### 4. Size

Screen Size (H x L)	Code	Price		
<b>One Seat, Single-Sided</b>		Acrylic	Fabric	Markerboard
12" x 48"	DS1248	\$314	\$367	\$275
12" x 54"	DS1254	\$343	\$384	\$298
12" x 60"	DS1260	\$414	\$445	\$364
12" x 66"	DS1266	\$443	\$465	\$387
12" x 72"	DS1272	\$471	\$485	\$410
18" x 48"	DS1848	\$427	\$477	\$366
18" x 54"	DS1854	\$468	\$503	\$401
18" x 60"	DS1860	\$555	\$570	\$478
18" x 66"	DS1866	\$557	\$598	\$513
18" x 72"	DS1872	\$594	\$625	\$549
24" x 48"	DS2448	\$488	\$509	\$458
24" x 54"	DS2454	\$551	\$555	\$505
24" x 60"	DS2460	\$631	\$650	\$594
24" x 66"	DS2466	\$680	\$706	\$640
24" x 72"	DS2472	\$731	\$770	\$685
<b>Two Seat, Single-Sided</b>		Acrylic	Fabric	Markerboard
12" x 48"	DS1248	\$628	\$734	\$550
12" x 54"	DS1254	\$686	\$768	\$596
12" x 60"	DS1260	\$828	\$890	\$728
12" x 66"	DS1266	\$886	\$930	\$774
12" x 72"	DS1272	\$942	\$970	\$820
18" x 48"	DS1848	\$854	\$954	\$732
18" x 54"	DS1854	\$936	\$1,006	\$802
18" x 60"	DS1860	\$1,110	\$1,140	\$956
18" x 66"	DS1866	\$1,114	\$1,196	\$1,026
18" x 72"	DS1872	\$1,188	\$1,250	\$1,098
24" x 48"	DS2448	\$976	\$1,018	\$916
24" x 54"	DS2454	\$1,102	\$1,110	\$1,010
24" x 60"	DS2460	\$1,262	\$1,300	\$1,188
24" x 66"	DS2466	\$1,360	\$1,412	\$1,280
24" x 72"	DS2472	\$1,462	\$1,540	\$1,370

**4. Size (Cont.)**

Screen Size (H x L)	Code	Price		
Three Seats, Single-Sided		Acrylic	Fabric	Markerboard
12" x 48"	DS1248	\$942	\$1,101	\$825
12" x 54"	DS1254	\$1,029	\$1,152	\$894
12" x 60"	DS1260	\$1,242	\$1,335	\$1,092
12" x 66"	DS1266	\$1,329	\$1,395	\$1,161
12" x 72"	DS1272	\$1,413	\$1,455	\$1,230
18" x 48"	DS1848	\$1,281	\$1,431	\$1,098
18" x 54"	DS1854	\$1,404	\$1,509	\$1,203
18" x 60"	DS1860	\$1,665	\$1,710	\$1,434
18" x 66"	DS1866	\$1,671	\$1,794	\$1,539
18" x 72"	DS1872	\$1,782	\$1,875	\$1,647
24" x 48"	DS2448	\$1,464	\$1,527	\$1,374
24" x 54"	DS2454	\$1,653	\$1,665	\$1,515
24" x 60"	DS2460	\$1,893	\$1,950	\$1,782
24" x 66"	DS2466	\$2,040	\$2,118	\$1,920
24" x 72"	DS2472	\$2,193	\$2,310	\$2,055
Four Seats, Single-Sided		Acrylic	Fabric	Markerboard
12" x 48"	DS1248	\$1,256	\$1,468	\$1,100
12" x 54"	DS1254	\$1,372	\$1,536	\$1,192
12" x 60"	DS1260	\$1,656	\$1,780	\$1,456
12" x 66"	DS1266	\$1,772	\$1,860	\$1,548
12" x 72"	DS1272	\$1,884	\$1,940	\$1,640
18" x 48"	DS1848	\$1,708	\$1,908	\$1,464
18" x 54"	DS1854	\$1,872	\$2,012	\$1,604
18" x 60"	DS1860	\$2,220	\$2,280	\$1,912
18" x 66"	DS1866	\$2,228	\$2,392	\$2,052
18" x 72"	DS1872	\$2,376	\$2,500	\$2,196
24" x 48"	DS2448	\$1,952	\$2,036	\$1,832
24" x 54"	DS2454	\$2,204	\$2,220	\$2,020
24" x 60"	DS2460	\$2,524	\$2,600	\$2,376
24" x 66"	DS2466	\$2,720	\$2,824	\$2,560
24" x 72"	DS2472	\$2,924	\$3,080	\$2,740

**4. Size (Cont.)**

Screen Size (H x L)	Code	Price		
Two Seats, Back-to-Back		Acrylic	Fabric	Markerboard
12" x 48"	DS1248	\$226	\$279	\$187
12" x 54"	DS1254	\$255	\$296	\$210
12" x 60"	DS1260	\$282	\$313	\$232
12" x 66"	DS1266	\$311	\$333	\$255
12" x 72"	DS1272	\$339	\$353	\$278
18" x 48"	DS1848	\$339	\$389	\$278
18" x 54"	DS1854	\$380	\$415	\$313
18" x 60"	DS1860	\$423	\$438	\$346
18" x 66"	DS1866	\$425	\$466	\$381
18" x 72"	DS1872	\$462	\$493	\$417
24" x 48"	DS2448	\$400	\$421	\$370
24" x 54"	DS2454	\$463	\$467	\$417
24" x 60"	DS2460	\$499	\$518	\$462
24" x 66"	DS2466	\$548	\$574	\$508
24" x 72"	DS2472	\$599	\$638	\$553
Four Seats, Back-to-Back		Acrylic	Fabric	Markerboard
12" x 48"	DS1248	\$452	\$558	\$374
12" x 54"	DS1254	\$510	\$592	\$420
12" x 60"	DS1260	\$564	\$626	\$464
12" x 66"	DS1266	\$622	\$666	\$510
12" x 72"	DS1272	\$678	\$706	\$556
18" x 48"	DS1848	\$678	\$778	\$556
18" x 54"	DS1854	\$760	\$830	\$626
18" x 60"	DS1860	\$846	\$876	\$692
18" x 66"	DS1866	\$850	\$932	\$762
18" x 72"	DS1872	\$924	\$986	\$834
24" x 48"	DS2448	\$800	\$842	\$740
24" x 54"	DS2454	\$926	\$934	\$834
24" x 60"	DS2460	\$998	\$1,036	\$924
24" x 66"	DS2466	\$1,096	\$1,148	\$1,016
24" x 72"	DS2472	\$1,198	\$1,276	\$1,106

**4. Size (Cont.)**

Screen Size (H x L)	Code	Price		
Six Seats, Back-to-Back		Acrylic	Fabric	Markerboard
12" x 48"	DS1248	\$678	\$837	\$561
12" x 54"	DS1254	\$765	\$888	\$630
12" x 60"	DS1260	\$846	\$939	\$696
12" x 66"	DS1266	\$933	\$999	\$765
12" x 72"	DS1272	\$1,017	\$1,059	\$834
18" x 48"	DS1848	\$1,017	\$1,167	\$834
18" x 54"	DS1854	\$1,140	\$1,245	\$939
18" x 60"	DS1860	\$1,269	\$1,314	\$1,038
18" x 66"	DS1866	\$1,275	\$1,398	\$1,143
18" x 72"	DS1872	\$1,386	\$1,479	\$1,251
24" x 48"	DS2448	\$1,200	\$1,263	\$1,110
24" x 54"	DS2454	\$1,389	\$1,401	\$1,251
24" x 60"	DS2460	\$1,497	\$1,554	\$1,386
24" x 66"	DS2466	\$1,644	\$1,722	\$1,524
24" x 72"	DS2472	\$1,797	\$1,914	\$1,659
Eight Seats, Back-to-Back		Acrylic	Fabric	Markerboard
12" x 48"	DS1248	\$904	\$1,116	\$748
12" x 54"	DS1254	\$1,020	\$1,184	\$840
12" x 60"	DS1260	\$1,128	\$1,252	\$928
12" x 66"	DS1266	\$1,244	\$1,332	\$1,020
12" x 72"	DS1272	\$1,356	\$1,412	\$1,112
18" x 48"	DS1848	\$1,356	\$1,556	\$1,112
18" x 54"	DS1854	\$1,520	\$1,660	\$1,252
18" x 60"	DS1860	\$1,692	\$1,752	\$1,384
18" x 66"	DS1866	\$1,700	\$1,864	\$1,524
18" x 72"	DS1872	\$1,848	\$1,972	\$1,668
24" x 48"	DS2448	\$1,600	\$1,684	\$1,480
24" x 54"	DS2454	\$1,852	\$1,868	\$1,668
24" x 60"	DS2460	\$1,996	\$2,072	\$1,848
24" x 66"	DS2466	\$2,192	\$2,296	\$2,032
24" x 72"	DS2472	\$2,396	\$2,552	\$2,212

**1. Power**

Product Type	Code	Price
Data Pack	3029 PDP	+ \$51

# Power Beam

SINGLE-SIDED | BACK-TO-BACK  
INFEEED COVER | WIRE MANAGEMENT  
POWER | DATA | DUPLEXES

# eBEAM

POWER + DATA BEAM

## *Power innovation.*

eBEAM is a straightforward, streamlined solution for adding power to your workstations. With adaptable legs, multiple beam lengths and cable management options that make it practically mess-free, eBEAM is simply powerful (and powerfully simple).

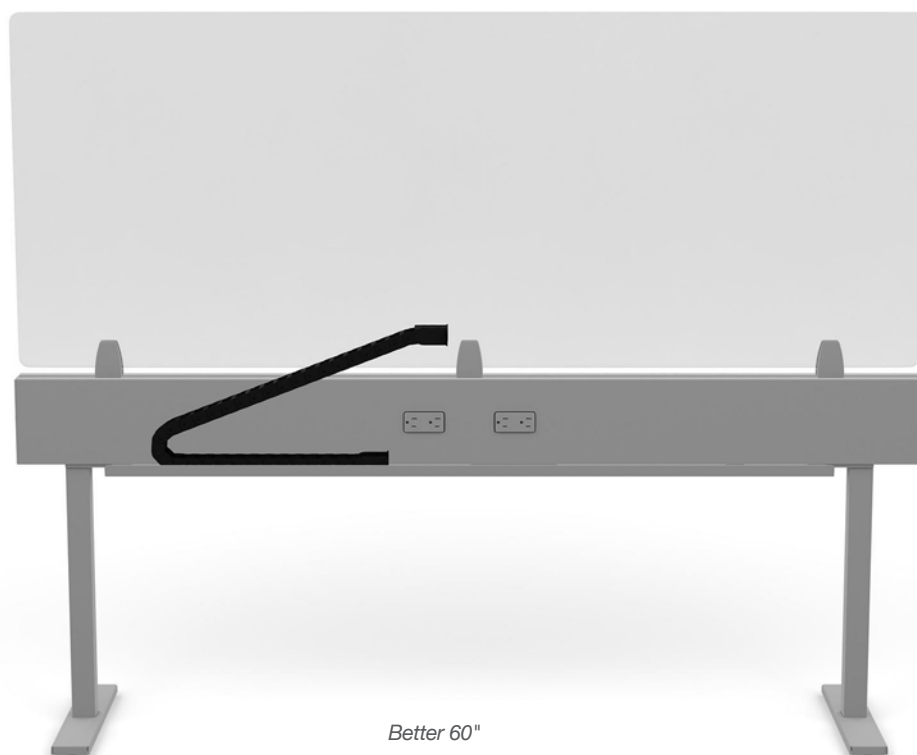

**EFFECTIVE DECEMBER 1, 2021**

## Featured Models

### **60" 2-SEAT WITH NO ACCESSORIES :: \$1,079**

60" beam, back to back, 2-seat, 72" conduit infeed, four duplex receptacles, no accessories

### **60" 2-SEAT WITH ACCESSORIES :: \$2,030**

60" beam, back to back, 2-seat, 72" conduit infeed, four duplex receptacles, horizontal wire tray, vertical wire manager, 24" x 60" frosted acrylic screen

### **60" 4-SEAT WITH ACCESSORIES :: \$3,832**

60" beam, back to back, 4-seat, 72" conduit infeed, four duplex receptacles, horizontal wire tray, vertical wire manager, infeed cover, 24" x 60" grade 1 fabric screen

### Features

- Quick and easy installation in less than 10 minutes
- Cable management accessories ensure an uncluttered look
- Responsive, adaptable design includes moveable leg positions
- Fits perfectly with any static or height-adjustable tabletop
- Seamless screen integration for providing privacy
- Beam sizes: 48," 60" and 72" (W) x 24 inches (H)
- Screen height options: 12", 18", 24" and 30"
- Screen material options: Clear acrylic, frosted acrylic, fabric and whiteboard
- 10 standard configurations.  
Single-sided: 1-seat, 2-seat, 3-seat, 4-seat and 5-seat.  
Back-to-back: 2-seat, 4-seat, 6-seat, 8-seat and 10-seat with adjustable leg positions
- 4-circuit, 8-wire power system included with standard or optional controlled duplex receptacles
- Power system is UL183 Listed
- Toolless power installation
- Optional horizontal, vertical and infeed wire management
- Data adapter kit included
- Data modules not included. See page 478 for a list of compatible modules.
- Tabletops that are 2" undersized are available and strongly recommended for use with eBEAM

### 1. Product

Product Type	Code	Price	
Power Beam	3242	Priced by Seated Positions	

Beam Length	Code	Price	
48" W Power Beam	TW48	Priced by Seated Positions	
60" W Power Beam	TW60	Priced by Seated Positions	
72" W Power Beam	TW72	Priced by Seated Positions	

### 1. Product (Cont.)

Orientation	Code	Price	
Single-Sided	SS	Priced by Seated Positions	
Back-to-Back	BB	Priced by Seated Positions	

Seated Position	Code	Price	
<b>Single-Sided</b>			
1-Seat, 48"	SP1	\$973	
1-Seat, 60"	SP1	\$1,011	
1-Seat, 72"	SP1	\$1,048	
2-Seat, 48"	SP2	\$1,634	
2-Seat, 60"	SP2	\$1,702	
2-Seat, 72"	SP2	\$1,769	
3-Seat, 48"	SP3	\$2,386	
3-Seat, 60"	SP3	\$2,487	
3-Seat, 72"	SP3	\$2,589	
4-Seat, 48"	SP4	\$3,138	
4-Seat, 60"	SP4	\$3,273	
4-Seat, 72"	SP4	\$3,408	
5-Seat, 48"	SP5	\$3,890	
5-Seat, 60"	SP5	\$4,059	
5-Seat, 72"	SP5	\$4,228	
<b>Back-to-Back</b>			
2-Seat, 48"	SP2	\$1,041	
2-Seat, 60"	SP2	\$1,079	
2-Seat, 72"	SP2	\$1,116	
4-Seat, 48"	SP4	\$1,770	
4-Seat, 60"	SP4	\$1,838	
4-Seat, 72"	SP4	\$1,905	
6-Seat, 48"	SP6	\$2,590	
6-Seat, 60"	SP6	\$2,691	
6-Seat, 72"	SP6	\$2,793	
8-Seat, 48"	SP8	\$3,410	
8-Seat, 60"	SP8	\$3,545	
8-Seat, 72"	SP8	\$3,680	
10-Seat, 48"	SP10	\$4,230	
10-Seat, 60"	SP10	\$4,399	
10-Seat, 72"	SP10	\$4,568	

Beams come standard with a standard 72" power infeed.

## 2. Finish

Paint Color	Code	Price
Silver	BF01	+ \$0
White	BF02	+ \$0
Black	BF03	+ \$0

## 3. Wire Management

Wire Management Type	Code	Price
No Wire Management	WM00	+ \$0
<b>Horizontal Wire Tray</b>		
1-Seat	WM01	+ \$92
2-Seat	WM01	+ \$184
3-Seat	WM01	+ \$276
4-Seat	WM01	+ \$368
5-Seat	WM01	+ \$460
6-Seat	WM01	+ \$552
8-Seat	WM01	+ \$736
10-Seat	WM01	+ \$920
<b>Horizontal Wire Tray And Vertical Wire Manager</b>		
1-Seat	WM06	+ \$184
2-Seat	WM06	+ \$368
3-Seat	WM06	+ \$552
4-Seat	WM06	+ \$736
5-Seat	WM06	+ \$920
6-Seat	WM06	+ \$1,104
8-Seat	WM06	+ \$1,472
10-Seat	WM06	+ \$1,840
<b>Infeed Cover</b>		
No Power Infeed Cover	VLC0	\$0
Power Infeed Cover	VLC1	+ \$54

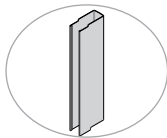
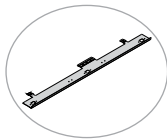
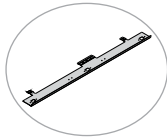

## POWER BEAM

## 4. Electrical

Type and Length	Code	Price
<b>Power Infeed</b>		
No Infeed	NPIF	- \$129
72" Conduit	PIC72	+ \$0
72" Liquidtight	PIL72	+ \$10
144" Conduit	PIC144	+ \$40
144" Liquidtight	PIL144	+ \$51
<b>No Power, Single-Sided</b>		
1-Seat	NPOW	- \$249
2-Seat	NPOW	- \$446
3-Seat	NPOW	- \$643
4-Seat	NPOW	- \$840
5-Seat	NPOW	- \$1,037
<b>No Power, Back-to-Back</b>		
2-Seat	NPOW	- \$249
4-Seat	NPOW	- \$446
6-Seat	NPOW	- \$643
8-Seat	NPOW	- \$840
10-Seat	NPOW	- \$1,037
<b>Duplexes</b>		
Standard Duplex Receptacles, Two Per Seat	SDUP	+ \$0
<b>No Duplexes</b>		
1-Seat	NDUP	- \$68
2-Seat	NDUP	- \$136
3-Seat	NDUP	- \$204
4-Seat	NDUP	- \$272
5-Seat	NDUP	- \$340
6-Seat	NDUP	- \$408
8-Seat	NDUP	- \$544
10-Seat	NDUP	- \$680

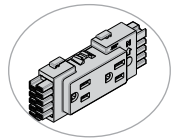
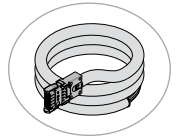

Duplex receptacle color will match beam color. When power is specified in beam, it includes duplexes for circuits 1, 2, 3, and 4. For other combinations of duplexes and controlled duplexes, specify "no duplexes" and order as standalone components.



POWER BEAM SCREENS

1. Product

Product Type	Code	Price	
Screen for eBEAM	3243	Priced by Size	
Beam	Code	Price	
48"	TW48	Priced by Size	
60"	TW60	Priced by Size	
72"	TW72	Priced by Size	
Beam Orientation	Code	Price	
Single-Sided	SS	Priced by Size	
Back-to-Back	BB	Priced by Size	
Seated Positions	Code	Price	
Single-Sided			
1-Seat	SP1	Priced by Size	
2-Seat	SP2	Priced by Size	
3-Seat	SP3	Priced by Size	
4-Seat	SP4	Priced by Size	
5-Seat	SP5	Priced by Size	
Back-to-Back			
2-Seat	SP2	Priced by Size	
4-Seat	SP4	Priced by Size	
6-Seat	SP6	Priced by Size	
8-Seat	SP8	Priced by Size	
10-Seat	SP10	Priced by Size	

2. Material

Material Type	Code	Price	
Motif Fabric	DT701	Priced by Size	
Sector Frosted Acrylic	DT101	Priced by Size	
Sector Clear Acrylic	DT101C	Priced by Size	
Doodle Markerboard	DT301	Priced by Size	
Grade	Code	Price	
Fabric/Vinyl Grade 1	FG1/VG1	Priced by Size	
Fabric/Vinyl Grade 2	FG2/VG2	Priced by Size	
Fabric/Vinyl Grade 3	FG3/VG3	Priced by Size	
Fabric/Vinyl Grade 4	FG4/VG4	Priced by Size	
Fabric/Vinyl Grade 5	FG5/VG5	Priced by Size	

The following prices are for grade 1 fabrics/vinyls only. For higher grade pricing, add the appropriate upcharge from the Motif price list.

3. Size

Screen Size (H x L)	Code	Grade 1 Price		
		Acrylic	Fabric	Markerboard
1-Seat, Single-Sided				
12" x 48"	DS1248	\$282	\$335	\$243
18" x 48"	DS1848	\$395	\$445	\$334
24" x 48"	DS2448	\$456	\$477	\$426
30" x 48"	DS3048	N/A	\$589	\$504
12" x 60"	DS1260	\$366	\$397	\$316
18" x 60"	DS1860	\$507	\$522	\$430
24" x 60"	DS2460	\$583	\$602	\$546
30" x 60"	DS3060	N/A	\$710	\$643
12" x 72"	DS1272	\$423	\$437	\$362
18" x 72"	DS1872	\$546	\$577	\$501
24" x 72"	DS2472	\$683	\$722	\$637
30" x 72"	DS3072	N/A	\$745	\$754
2-Seat, Single-Sided				
12" x 48"	DS1248	\$564	\$670	\$486
18" x 48"	DS1848	\$790	\$890	\$668
24" x 48"	DS2448	\$912	\$954	\$852
30" x 48"	DS3048	N/A	\$1,178	\$1,008
12" x 60"	DS1260	\$732	\$794	\$632
18" x 60"	DS1860	\$1,014	\$1,044	\$860
24" x 60"	DS2460	\$1,166	\$1,204	\$1,092
30" x 60"	DS3060	N/A	\$1,420	\$1,286
12" x 72"	DS1272	\$846	\$874	\$724
18" x 72"	DS1872	\$1,092	\$1,154	\$1,002
24" x 72"	DS2472	\$1,366	\$1,444	\$1,274
30" x 72"	DS3072	N/A	\$1,490	\$1,508
3-Seat, Single-Sided				
12" x 48"	DS1248	\$846	\$1,005	\$729
18" x 48"	DS1848	\$1,185	\$1,335	\$1,002
24" x 48"	DS2448	\$1,368	\$1,431	\$1,278
30" x 48"	DS3048	N/A	\$1,767	\$1,512
12" x 60"	DS1260	\$1,098	\$1,191	\$948
18" x 60"	DS1860	\$1,521	\$1,566	\$1,290
24" x 60"	DS2460	\$1,749	\$1,806	\$1,638
30" x 60"	DS3060	N/A	\$2,130	\$1,929
12" x 72"	DS1272	\$1,269	\$1,311	\$1,086
18" x 72"	DS1872	\$1,638	\$1,731	\$1,503
24" x 72"	DS2472	\$2,049	\$2,166	\$1,911
30" x 72"	DS3072	N/A	\$2,235	\$2,262

4. Size (Cont.)

Screen Size (H x L)	Code	Grade 1 Price		
		Acrylic	Fabric	Markerboard
<b>4-Seat, Single-Sided</b>				
12" x 48"	DS1248	\$1,128	\$1,340	\$972
18" x 48"	DS1848	\$1,580	\$1,780	\$1,336
24" x 48"	DS2448	\$1,824	\$1,908	\$1,704
30" x 48"	DS3048	N/A	\$2,356	\$2,016
12" x 60"	DS1260	\$1,464	\$1,588	\$1,264
18" x 60"	DS1860	\$2,028	\$2,088	\$1,720
24" x 60"	DS2460	\$2,332	\$2,408	\$2,184
30" x 60"	DS3060	N/A	\$2,840	\$2,572
12" x 72"	DS1272	\$1,692	\$1,748	\$1,448
18" x 72"	DS1872	\$2,184	\$2,308	\$2,004
24" x 72"	DS2472	\$2,732	\$2,888	\$2,548
30" x 72"	DS3072	N/A	\$2,980	\$3,016
<b>5-Seat, Single-Sided</b>				
12" x 48"	DS1248	\$1,410	\$1,675	\$1,215
18" x 48"	DS1848	\$1,975	\$2,225	\$1,670
24" x 48"	DS2448	\$2,280	\$2,385	\$2,130
30" x 48"	DS3048	N/A	\$2,945	\$2,520
12" x 60"	DS1260	\$1,830	\$1,985	\$1,580
18" x 60"	DS1860	\$2,535	\$2,610	\$2,150
24" x 60"	DS2460	\$2,915	\$3,010	\$2,730
30" x 60"	DS3060	N/A	\$3,550	\$3,215
12" x 72"	DS1272	\$2,115	\$2,185	\$1,810
18" x 72"	DS1872	\$2,730	\$2,885	\$2,505
24" x 72"	DS2472	\$3,415	\$3,610	\$3,185
30" x 72"	DS3072	N/A	\$3,725	\$3,770
<b>2-Seat, Back-to-Back</b>				
12" x 48"	DS1248	\$282	\$335	\$243
18" x 48"	DS1848	\$395	\$445	\$334
24" x 48"	DS2448	\$456	\$477	\$426
30" x 48"	DS3048	N/A	\$589	\$504
12" x 60"	DS1260	\$366	\$397	\$316
18" x 60"	DS1860	\$507	\$522	\$430
24" x 60"	DS2460	\$583	\$602	\$546
30" x 60"	DS3060	N/A	\$710	\$643
12" x 72"	DS1272	\$423	\$437	\$362
18" x 72"	DS1872	\$546	\$577	\$501
24" x 72"	DS2472	\$683	\$722	\$637
30" x 72"	DS3072	N/A	\$745	\$754

4. Size (Cont.)

Screen Size (H x L)	Code	Grade 1 Price		
		Acrylic	Fabric	Markerboard
<b>4-Seat, Back-to-Back</b>				
12" x 48"	DS1248	\$564	\$670	\$486
18" x 48"	DS1848	\$790	\$890	\$668
24" x 48"	DS2448	\$912	\$954	\$852
30" x 48"	DS3048	N/A	\$1,178	\$1,008
12" x 60"	DS1260	\$732	\$794	\$632
18" x 60"	DS1860	\$1,014	\$1,044	\$860
24" x 60"	DS2460	\$1,166	\$1,204	\$1,092
30" x 60"	DS3060	N/A	\$1,420	\$1,286
12" x 72"	DS1272	\$846	\$874	\$724
18" x 72"	DS1872	\$1,092	\$1,154	\$1,002
24" x 72"	DS2472	\$1,366	\$1,444	\$1,274
30" x 72"	DS3072	N/A	\$1,490	\$1,508
<b>6-Seat, Back-to-Back</b>				
12" x 48"	DS1248	\$846	\$1,005	\$729
18" x 48"	DS1848	\$1,185	\$1,335	\$1,002
24" x 48"	DS2448	\$1,368	\$1,431	\$1,278
30" x 48"	DS3048	N/A	\$1,767	\$1,512
12" x 60"	DS1260	\$1,098	\$1,191	\$948
18" x 60"	DS1860	\$1,521	\$1,566	\$1,290
24" x 60"	DS2460	\$1,749	\$1,806	\$1,638
30" x 60"	DS3060	N/A	\$2,130	\$1,929
12" x 72"	DS1272	\$1,269	\$1,311	\$1,086
18" x 72"	DS1872	\$1,638	\$1,731	\$1,503
24" x 72"	DS2472	\$2,049	\$2,166	\$1,911
30" x 72"	DS3072	N/A	\$2,235	\$2,262
<b>8-Seat, Back-to-Back</b>				
12" x 48"	DS1248	\$1,128	\$1,340	\$972
18" x 48"	DS1848	\$1,580	\$1,780	\$1,336
24" x 48"	DS2448	\$1,824	\$1,908	\$1,704
30" x 48"	DS3048	N/A	\$2,356	\$2,016
12" x 60"	DS1260	\$1,464	\$1,588	\$1,264
18" x 60"	DS1860	\$2,028	\$2,088	\$1,720
24" x 60"	DS2460	\$2,332	\$2,408	\$2,184
30" x 60"	DS3060	N/A	\$2,840	\$2,572
12" x 72"	DS1272	\$1,692	\$1,748	\$1,448
18" x 72"	DS1872	\$2,184	\$2,308	\$2,004
24" x 72"	DS2472	\$2,732	\$2,888	\$2,548
30" x 72"	DS3072	N/A	\$2,980	\$3,016

POWER BEAM SCREENS

4. Size (Cont.)

Screen Size (H x L)	Code	Grade 1 Price		
		Acrylic	Fabric	Markerboard
10-Seat, Back-to-Back				
12" x 48"	DS1248	\$1,410	\$1,675	\$1,215
18" x 48"	DS1848	\$1,975	\$2,225	\$1,670
24" x 48"	DS2448	\$2,280	\$2,385	\$2,130
30" x 48"	DS3048	N/A	\$2,945	\$2,520
12" x 60"	DS1260	\$1,830	\$1,985	\$1,580
18" x 60"	DS1860	\$2,535	\$2,610	\$2,150
24" x 60"	DS2460	\$2,915	\$3,010	\$2,730
30" x 60"	DS3060	N/A	\$3,550	\$3,215
12" x 72"	DS1272	\$2,115	\$2,185	\$1,810
18" x 72"	DS1872	\$2,730	\$2,885	\$2,505
24" x 72"	DS2472	\$3,415	\$3,610	\$3,185
30" x 72"	DS3072	N/A	\$3,725	\$3,770

5. Clamp Color

Paint Color	Code	Price
Silver	BF01	+\$0
White	BF02	+\$0
Black	BF03	+\$0

SPECIFICATIONS

	3242 TW42 42" Beam	3242 TW60 60" Beam	3242 TW72 72" Beam
<b>Dimensions</b>			
Beam Length (With End Cap)	48.75"	60.75"	72.75"
Beam Height	5.8"	5.8"	5.8"
Beam Width	2.5"	2.5"	2.5"
Overall Height	24.1"	24.1"	24.1"
Height From Floor to Beam	18.3"	18.3"	18.3"
Leg Width	2.5"	2.5"	2.5"
Foot Width	1.6"	1.6"	1.6"
Foot Length	14.5"	14.5"	14.5"
Length From End to Duplex	19.7"	25.7"	31.7"

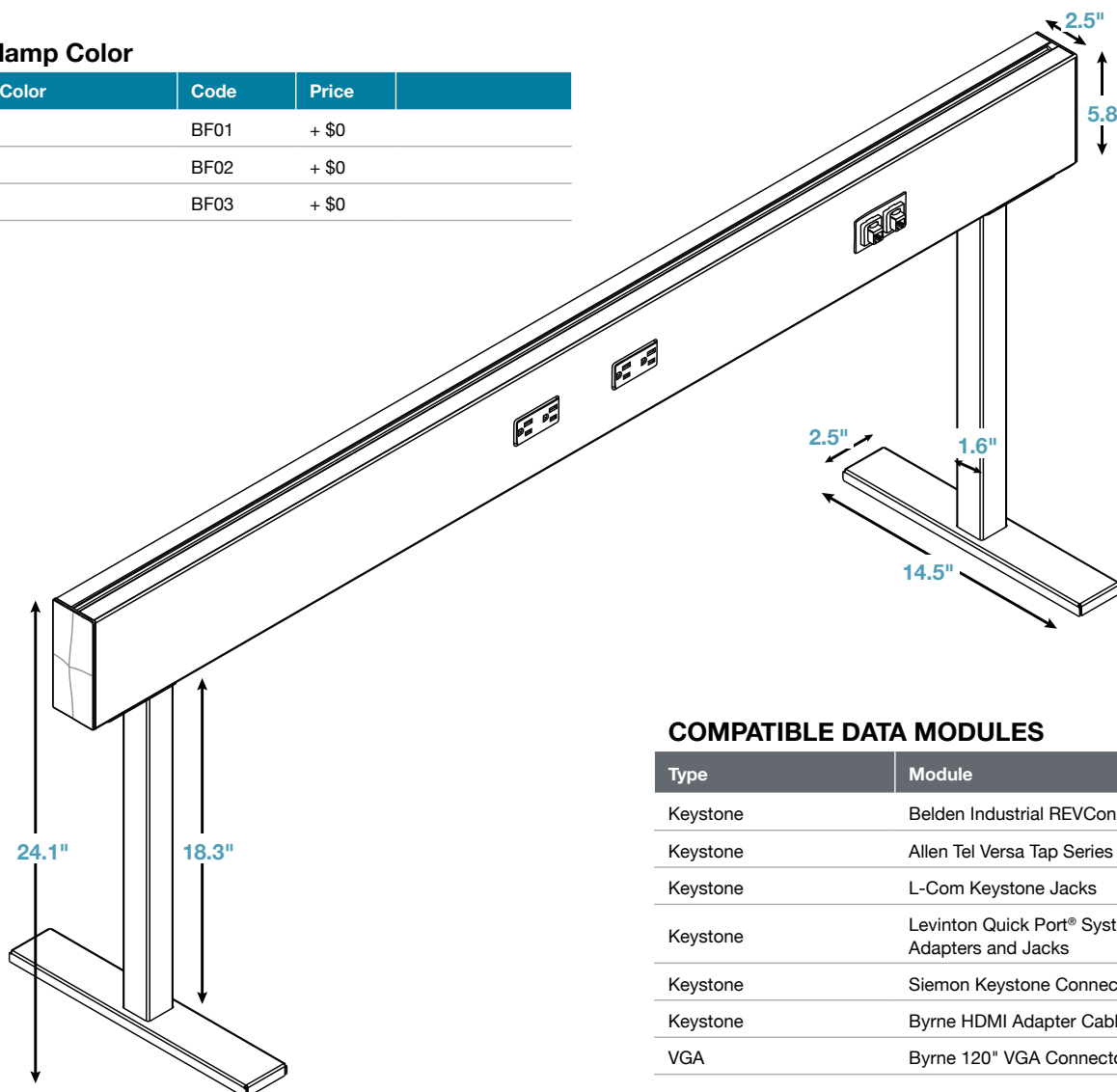

COMPATIBLE DATA MODULES

Type	Module
Keystone	Belden Industrial REVConnect
Keystone	Allen Tel Versa Tap Series
Keystone	L-Com Keystone Jacks
Keystone	Levinton Quick Port® System Adapters and Jacks
Keystone	Siemon Keystone Connectivity Solutions
Keystone	Byrne HDMI Adapter Cable
VGA	Byrne 120" VGA Connector

EFFECTIVE DECEMBER 1, 2021

**1. Product**

Category	Code	Price	
Stand-Alone Components for Power Beams	3249	Priced by Type	
Type	Code	Price	
<b>Electrical</b>			

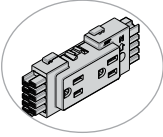
Duplex Receptacle	ATC04	\$34	
-------------------	-------	------	---

**Wire Management**

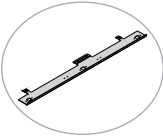
Horizontal Wire Tray	ATC01 WM01	\$92	
----------------------	---------------	------	---

Horizontal Wire Tray and Vertical Wire Manager	ATC01 WM06	\$184	
--	---------------	-------	--

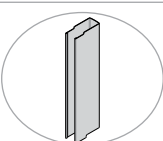
Power Infeed Cover	ATC02 VLC1	\$54	
--------------------	---------------	------	---

**2. Circuit (For Duplexes Only)**

Circuit Number	Code	Price	
Circuit 1	DC1	+ \$0	
Circuit 2	DC2	+ \$0	
Circuit 3	DC3	+ \$0	
Circuit 4	DC4	+ \$0	

Title 24 (Controlled)			
Circuit 1	DC1C	+ \$5	
Circuit 2	DC2C	+ \$5	
Circuit 3	DC3C	+ \$5	
Circuit 4	DC4C	+ \$5	

**3. Color**

Circuit Number	Code	Price	
Silver	BF01	+ \$0	
White	BF02	+ \$0	
Black	BF03	+ \$0	

Vertical wire managers are only available in black. Color will apply to the horizontal wire tray only.

# Screens

WORKSURFACE | MODESTY  
FREESTANDING | MOBILE | CAFÉ  
SEATING | TRANSACTION | TRIFOLD

# Doodle

## MARKERBOARD WORKSURFACE SCREEN

*Write away (right away).*

From big idea-making to simple note-taking, stay on task with a tool that helps you work. Our Doodle markerboards provide essential privacy as a screen while promoting impactful productivity as a convenient place to write.



12" x 23" Middle Mount  
Table not included. See page 426 for Tensor.  
Chairs not included. See page 86 for Ioniq.

EFFECTIVE DECEMBER 1, 2021

### Featured Models

**12" x 23" MIDDLE :: \$179**

12" x 23" markerboard screen,  
middle mount

**24" x 60" EDGE :: \$594**

24" x 60" markerboard screen,  
edge mount

**30" x 60" MIDWAY :: \$635**

30" x 60" markerboard screen,  
midway mount

## Features

- Non-ghosting, durable writing surface can withstand endless scribbles and wipes
- Compatible with dry erase and wet erase markers
- Slim, straightforward design mixes well with any workspace
- Height options: 12, 18 and 24 inches; 30 inches available for midway and height-adjustable mounts
- Width options: 17 to 72 inches (in six-inch increments)
- Compatible with most mounts, including edge, middle, top, midway, freestanding, panel and height-adjustable

### 1. Product

Product Type	Code	Price
Worksurface Screen	3090	Priced by Size

### 2. Material

Material	Code	Price
Markerboard	DT301	Priced by Size

### 3. Size



Screen Size (H x W)	Code	Price
<b>17" Wide Side Screen</b>		
12" x 17"	DS1217	\$68
18" x 17"	DS1817	\$100
24" x 17"	DS2417	\$133
<b>23" Wide Side Screen</b>		
12" x 23"	DS1223	\$91
18" x 23"	DS1823	\$135
24" x 23"	DS2423	\$179
<b>29" Wide Side Screen</b>		
12" x 29"	DS1229	\$113
18" x 29"	DS1829	\$170
24" x 29"	DS2429	\$224
<b>24" Wide Screen</b>		
24" x 24"	DS2424	\$179
30" x 24"	DS3024	\$224

## MARKERBOARD WORKSURFACE SCREEN

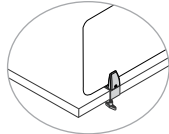
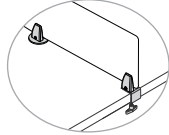
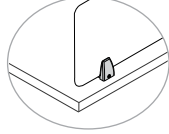
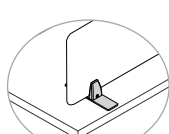
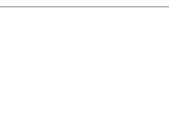
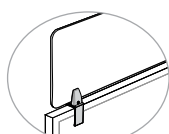

### 3. Size (Cont.)

Screen Size (H x W)	Code	Price
<b>30" Wide Screen</b>		
24" x 30"	DS2430	\$224
30" x 30"	DS3030	\$281
<b>36" Wide Screen</b>		
12" x 36"	DS1236	\$140
18" x 36"	DS1836	\$210
24" x 36"	DS2436	\$278
30" x 36"	DS3036	\$336
<b>42" Wide Screen</b>		
12" x 42"	DS1242	\$162
18" x 42"	DS1842	\$243
24" x 42"	DS2442	\$323
30" x 42"	DS3042	\$393
<b>48" Wide Screen</b>		
12" x 48"	DS1248	\$187
18" x 48"	DS1848	\$278
24" x 48"	DS2448	\$370
30" x 48"	DS3048	\$448
<b>54" Wide Screen</b>		
12" x 54"	DS1254	\$210
18" x 54"	DS1854	\$313
24" x 54"	DS2454	\$417
30" x 54"	DS3054	\$503
<b>60" Wide Screens</b>		
12" x 60"	DS1260	\$232
18" x 60"	DS1860	\$346
24" x 60"	DS2460	\$462
30" x 60"	DS3060	\$559
<b>66" Wide Screen</b>		
12" x 66"	DS1266	\$255
18" x 66"	DS1866	\$381
24" x 66"	DS2466	\$508
30" x 66"	DS3066	\$614
<b>72" Wide Screen</b>		
12" x 72"	DS1272	\$278
18" x 72"	DS1872	\$417
24" x 72"	DS2472	\$553
30" x 72"	DS3072	\$670

### 4. Mount

Mount Style	Code	Price	
<b>Protective/Privacy</b>			
Edge Mount Compatibility: 17"-54" Screen Width 12"-24" Screen Height	MT1	+ \$88	
Edge Mount Compatibility: 60"-72" Screen Width 12"-24" Screen Height	MT1	+ \$132	
Middle Mount Compatibility: 17"-29" Screen Width 12"-24" Screen Height	MT2	+ \$88	
Top Mount Compatibility: 17"-54" Screen Width 12"-24" Screen Height	MT3	+ \$56	
Top Mount Compatibility: 60"-72" Screen Width 12"-24" Screen Height	MT3	+ \$84	
Freestanding Mount Compatibility: 17"-54" Screen Width 12"-24" Screen Height	MT4	+ \$88	
Freestanding Mount Compatibility: 60"-72" Screen Width 12"-24" Screen Height	MT4	+ \$132	
Small Panel Mount Compatibility: 1.5"-2.3" Panel Depth 17"-54" Screen Width 12"-24" Screen Height	MT9	+ \$88	
Small Panel Mount Compatibility: 1.5"-2.3" Panel Depth 60"-72" Screen Width 12"-24" Screen Height	MT9	+ \$132	
Large Panel Mount Compatibility: 2.3"-3.7" Panel Depth 17"-54" Screen Width 12"-24" Screen Height	MT10	+ \$88	
Large Panel Mount Compatibility: 2.3"-3.7" Panel Depth 60"-72" Screen Width 12"-24" Screen Height	MT10	+ \$132	

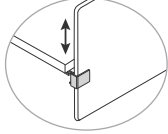
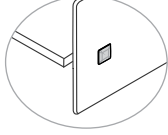
### 4. Mount (Cont.)

Mount Style	Code	Price	
<b>Protective/Privacy + Modesty</b>			
Height-Adjustable Compatibility: 24"-60" Screen Width 24"-30" Screen Height	MT6	+ \$80	
Midway Compatibility: 17"-54" Screen Width 24"-30" Screen Height	MT5	+ \$38	
Midway Compatibility: 60"-72" Screen Width 24"-30" Screen Height	MT5	+ \$76	



# Modesty

WORKSURFACE SCREEN

## *Versatile peace of mind.*

We all need our own space. Increase office and employee privacy with our selection of modesty screens that attach right onto our desks and benches. In addition, shield cords, wires and more from sight for a clean and organized workspace.



*Frosted Acrylic Modesty Screen  
Table not included. See page 392 for Ocala.  
Chair not included. See page 167 for Wit.*

**EFFECTIVE DECEMBER 1, 2021**

## Featured Models

### **LAMINATE :: \$275**

10" x 60" laminate screen

### **ACRYLIC :: \$369**

10" x 60" frosted acrylic screen

### Features

- Extra privacy for users
- Attaches onto edge of bench or table
- Can be installed fixed or hinged
- Screens can be built from frosted acrylic or laminate
- Eleven different durable laminate options to fit your style
- Eleven different durable laminate options to fit your style
- Screens are 10" high and available in widths ranging from 36" to 72"
- Acrylic panels are 0.24" thick; laminate screens are 1.125" thick

### 1. Product

Product Type	Code	Price
Modesty Screen	3093	Priced by Size

### 2. Material

Material Type	Code	Price
Frosted Acrylic	DT101	Priced by Size
Laminate	DT501	Priced by Size
Laminate	Code	Price
Ankara Cherry	MPC18	+ \$0
Black	MPC19	+ \$0
Brazilian Walnut	MPC20	+ \$0
Cabinet Maple	MPC21	+ \$0
Driftwood	MPC23	+ \$0
Folkstone Grey	MPC24	+ \$0
Libretti	MPC25	+ \$0
Queenston Oak	MPC26	+ \$0
Sandalwood	MPC27	+ \$0
Walnut Amati	MPC28	+ \$0
White	MPC29	+ \$0

Select laminate finish only if ordering a laminate (DT501) screen.

### 3. Size

Screen Size (H x W)	Code	Price	
Modesty Screens		Acrylic	Laminate
10" x 36"	DS1036	\$253	\$190
10" x 42"	DS1042	\$282	\$223
10" x 48"	DS1048	\$312	\$233
10" x 54"	DS1054	\$341	\$254
10" x 60"	DS1060	\$369	\$275
10" x 66"	DS1066	\$400	\$297
10" x 72"	DS1072	\$446	\$317

### 4. Mount

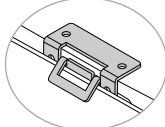
Mount Style	Code	Price	
Modesty Screen Mount Compatibility: 36"-72" Screen Width 10" Screen Height	MT8	+ \$0	

Modesty screens include the cost of the mount.

# Motif

## FABRIC WORKSURFACE SCREEN

### *Social distancing with style.*

Divide and conquer the challenges of the "new normal" with Motif. Our collection of modern, well-designed privacy and modesty screens help you fashion spaces that are safe, secluded and color coordinated with the entire office.



*30" x 60" Screen With Midway Mount  
Table not included; see page 426 for Tensor.*

**EFFECTIVE DECEMBER 1, 2021**

### Featured Models

**12" x 23" EDGE :: \$252**

12" x 23" fabric screen, edge mount, grade 1 textile

**30" x 48" HA :: \$613**

30" x 48" fabric screen, height-adjustable mount, grade 1 textile

**30" x 60" MIDWAY :: \$702**

30" x 60" fabric screen, midway mount, grade 1 textile

## Features

- Get customized privacy with durable fabrics designed to heal from pins, thumbtacks and more
- Find privacy + protection with fabrics that are bleach-cleanable, helping protect against COVID-19
- Eco-friendly, single-piece construction features a HexaCore honeycomb center, providing rigidity with less weight
- Height options include 12, 18, and 24 inches; 30 inches available for midway and height-adjustable mounts
- Width options range from 17 to 72 inches (in six-inch increments)
- Compatible with most mounts, including edge, middle, top, midway, freestanding, panel and height-adjustable

### 1. Product

Product Type	Code	Price
Screen	3090	Priced by Size

### 2. Material

Material Type	Code	Price			
Fabric/Vinyl	DT701	Priced by Grade and Size			
Material Grade	Code	12" (H) Price	18" (H) Price	24" (H) Price	30" (H) Price
<b>17" Wide Side Screens</b>		<b>12" x 17"</b>	<b>18" x 17"</b>	<b>24" x 17"</b>	<b>—</b>
Base Price		\$148	\$208	\$251	—
Fabric/Vinyl Grade 1	FG1/VG1	+\$0	+\$0	+\$0	—
Fabric/Vinyl Grade 2	FG2/VG2	+\$7	+\$7	+\$13	—
Fabric/Vinyl Grade 3	FG3/VG3	+\$18	+\$18	+\$36	—
Fabric/Vinyl Grade 4	FG4/VG4	+\$31	+\$31	+\$63	—
Fabric/Vinyl Grade 5	FG5/VG5	+\$54	+\$54	+\$107	—
<b>23" Wide Side Screens</b>		<b>12" x 23"</b>	<b>18" x 23"</b>	<b>24" x 23"</b>	<b>—</b>
Base Price		\$164	\$231	\$278	—
Fabric/Vinyl Grade 1	FG1/VG1	+\$0	+\$0	+\$0	—
Fabric/Vinyl Grade 2	FG2/VG2	+\$9	+\$9	+\$17	—
Fabric/Vinyl Grade 3	FG3/VG3	+\$23	+\$23	+\$46	—
Fabric/Vinyl Grade 4	FG4/VG4	+\$40	+\$40	+\$81	—
Fabric/Vinyl Grade 5	FG5/VG5	+\$69	+\$69	+\$138	—

2. Material (Cont.)

Material Grade	Code	12" (H) Price	18" (H) Price	24" (H) Price	30" (H) Price
<b>29" Wide Side Screens</b>		<b>12" x 29"</b>	<b>18" x 29"</b>	<b>24" x 29"</b>	<b>—</b>
Base Price		\$182	\$255	\$308	—
Fabric/Vinyl Grade 1	FG1/VG1	+ \$0	+ \$0	+ \$0	—
Fabric/Vinyl Grade 2	FG2/VG2	+ \$11	+ \$11	+ \$21	—
Fabric/Vinyl Grade 3	FG3/VG3	+ \$28	+ \$28	+ \$57	—
Fabric/Vinyl Grade 4	FG4/VG4	+ \$50	+ \$50	+ \$99	—
Fabric/Vinyl Grade 5	FG5/VG5	+ \$85	+ \$85	+ \$170	—
<b>24" Wide Screens</b>		<b>—</b>	<b>—</b>	<b>24" x 24"</b>	<b>30" x 24"</b>
Base Price		—	—	\$278	\$353
Fabric/Vinyl Grade 1	FG1/VG1	—	—	+ \$0	+ \$0
Fabric/Vinyl Grade 2	FG2/VG2	—	—	+ \$18	+ \$18
Fabric/Vinyl Grade 3	FG3/VG3	—	—	+ \$48	+ \$48
Fabric/Vinyl Grade 4	FG4/VG4	—	—	+ \$84	+ \$84
Fabric/Vinyl Grade 5	FG5/VG5	—	—	+ \$144	+ \$144
<b>30" Wide Screens</b>		<b>—</b>	<b>—</b>	<b>24" x 30"</b>	<b>30" x 30"</b>
Base Price		—	—	\$308	\$390
Fabric/Vinyl Grade 1	FG1/VG1	—	—	+ \$0	+ \$0
Fabric/Vinyl Grade 2	FG2/VG2	—	—	+ \$22	+ \$22
Fabric/Vinyl Grade 3	FG3/VG3	—	—	+ \$58	+ \$58
Fabric/Vinyl Grade 4	FG4/VG4	—	—	+ \$102	+ \$102
Fabric/Vinyl Grade 5	FG5/VG5	—	—	+ \$176	+ \$176
<b>36" Wide Screens</b>		<b>12" x 36"</b>	<b>18" x 36"</b>	<b>24" x 36"</b>	<b>30" x 36"</b>
Base Price		\$214	\$300	\$342	\$434
Fabric/Vinyl Grade 1	FG1/VG1	+ \$0	+ \$0	+ \$0	+ \$0
Fabric/Vinyl Grade 2	FG2/VG2	+ \$13	+ \$13	+ \$26	+ \$26
Fabric/Vinyl Grade 3	FG3/VG3	+ \$35	+ \$35	+ \$69	+ \$69
Fabric/Vinyl Grade 4	FG4/VG4	+ \$60	+ \$60	+ \$121	+ \$121
Fabric/Vinyl Grade 5	FG5/VG5	+ \$104	+ \$104	+ \$208	+ \$208
<b>42" Wide Screens</b>		<b>12" x 42"</b>	<b>18" x 42"</b>	<b>24" x 42"</b>	<b>30" x 42"</b>
Base Price		\$247	\$345	\$379	\$481
Fabric/Vinyl Grade 1	FG1/VG1	+ \$0	+ \$0	+ \$0	+ \$0
Fabric/Vinyl Grade 2	FG2/VG2	+ \$15	+ \$15	+ \$30	+ \$30
Fabric/Vinyl Grade 3	FG3/VG3	+ \$40	+ \$40	+ \$80	+ \$80
Fabric/Vinyl Grade 4	FG4/VG4	+ \$70	+ \$70	+ \$140	+ \$140
Fabric/Vinyl Grade 5	FG5/VG5	+ \$120	+ \$120	+ \$240	+ \$240

2. Material (Cont.)

Material Grade	Code	12" (H) Price	18" (H) Price	24" (H) Price	30" (H) Price
<b>48" Wide Screens</b>		<b>12" x 48"</b>	<b>18" x 48"</b>	<b>24" x 48"</b>	<b>30" x 48"</b>
Base Price		\$279	\$389	\$421	\$533
Fabric/Vinyl Grade 1	FG1/VG1	+ \$0	+ \$0	+ \$0	+ \$0
Fabric/Vinyl Grade 2	FG2/VG2	+ \$17	+ \$17	+ \$34	+ \$34
Fabric/Vinyl Grade 3	FG3/VG3	+ \$45	+ \$45	+ \$90	+ \$90
Fabric/Vinyl Grade 4	FG4/VG4	+ \$79	+ \$79	+ \$158	+ \$158
Fabric/Vinyl Grade 5	FG5/VG5	+ \$136	+ \$136	+ \$272	+ \$272
<b>54" Wide Screens</b>		<b>12" x 54"</b>	<b>18" x 54"</b>	<b>24" x 54"</b>	<b>30" x 54"</b>
Base Price		\$296	\$415	\$467	\$564
Fabric/Vinyl Grade 1	FG1/VG1	+ \$0	+ \$0	+ \$0	+ \$0
Fabric/Vinyl Grade 2	FG2/VG2	+ \$19	+ \$19	+ \$38	+ \$38
Fabric/Vinyl Grade 3	FG3/VG3	+ \$50	+ \$50	+ \$101	+ \$101
Fabric/Vinyl Grade 4	FG4/VG4	+ \$88	+ \$88	+ \$177	+ \$177
Fabric/Vinyl Grade 5	FG5/VG5	+ \$152	+ \$152	+ \$304	+ \$304
<b>60" Wide Screens</b>		<b>12" x 60"</b>	<b>18" x 60"</b>	<b>24" x 60"</b>	<b>30" x 60"</b>
Base Price		\$313	\$438	\$518	\$626
Fabric/Vinyl Grade 1	FG1/VG1	+ \$0	+ \$0	+ \$0	+ \$0
Fabric/Vinyl Grade 2	FG2/VG2	+ \$21	+ \$21	+ \$42	+ \$42
Fabric/Vinyl Grade 3	FG3/VG3	+ \$56	+ \$56	+ \$112	+ \$112
Fabric/Vinyl Grade 4	FG4/VG4	+ \$98	+ \$98	+ \$196	+ \$196
Fabric/Vinyl Grade 5	FG5/VG5	+ \$168	+ \$168	+ \$336	+ \$336
<b>66" Wide Screens</b>		<b>12" x 66"</b>	<b>18" x 66"</b>	<b>24" x 66"</b>	<b>30" x 66"</b>
Base Price		\$333	\$466	\$574	\$644
Fabric/Vinyl Grade 1	FG1/VG1	+ \$0	+ \$0	+ \$0	+ \$0
Fabric/Vinyl Grade 2	FG2/VG2	+ \$23	+ \$23	+ \$46	+ \$46
Fabric/Vinyl Grade 3	FG3/VG3	+ \$61	+ \$61	+ \$122	+ \$122
Fabric/Vinyl Grade 4	FG4/VG4	+ \$107	+ \$107	+ \$214	+ \$214
Fabric/Vinyl Grade 5	FG5/VG5	+ \$184	+ \$184	+ \$368	+ \$368
<b>72" Wide Screens</b>		<b>12" x 72"</b>	<b>18" x 72"</b>	<b>24" x 72"</b>	<b>30" x 72"</b>
Base Price		\$353	\$493	\$638	\$661
Fabric/Vinyl Grade 1	FG1/VG1	+ \$0	+ \$0	+ \$0	+ \$0
Fabric/Vinyl Grade 2	FG2/VG2	+ \$25	+ \$25	+ \$50	+ \$50
Fabric/Vinyl Grade 3	FG3/VG3	+ \$66	+ \$66	+ \$133	+ \$133
Fabric/Vinyl Grade 4	FG4/VG4	+ \$116	+ \$116	+ \$233	+ \$233
Fabric/Vinyl Grade 5	FG5/VG5	+ \$200	+ \$200	+ \$400	+ \$400

Please reference the Textile Reference Guide for information on approved textiles for Motif products.







**3. Size**

Screen Size (H x W)	Code	Price
<b>17" Wide Side Screens</b>		
12" x 17"	DS1217	+ \$0
18" x 17"	DS1817	+ \$0
24" x 17"	DS2417	+ \$0
<b>23" Wide Side Screens</b>		
12" x 23"	DS1223	+ \$0
18" x 23"	DS1823	+ \$0
24" x 23"	DS2423	+ \$0
<b>29" Wide Side Screens</b>		
12" x 29"	DS1229	+ \$0
18" x 29"	DS1829	+ \$0
24" x 29"	DS2429	+ \$0
<b>24" Wide Screens</b>		
24" x 24"	DS2424	+ \$0
30" x 24"	DS3024	+ \$0
<b>30" Wide Screens</b>		
24" x 30"	DS2430	+ \$0
30" x 30"	DS3030	+ \$0
<b>36" Wide Screens</b>		
12" x 36"	DS1236	+ \$0
18" x 36"	DS1836	+ \$0
24" x 36"	DS2436	+ \$0
30" x 36"	DS3036	+ \$0
<b>42" Wide Screens</b>		
12" x 42"	DS1242	+ \$0
18" x 42"	DS1842	+ \$0
24" x 42"	DS2442	+ \$0
30" x 42"	DS3042	+ \$0

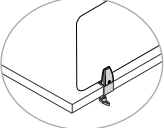
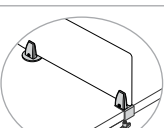
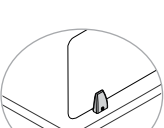
**3. Size (Cont.)**

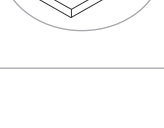
Screen Size (H x W)	Code	Price
<b>48" Wide Screens</b>		
12" x 48"	DS1248	+ \$0
18" x 48"	DS1848	+ \$0
24" x 48"	DS2448	+ \$0
30" x 48"	DS3048	+ \$0
<b>54" Wide Screens</b>		
12" x 54"	DS1254	+ \$0
18" x 54"	DS1854	+ \$0
24" x 54"	DS2454	+ \$0
30" x 54"	DS3054	+ \$0
<b>60" Wide Screens</b>		
12" x 60"	DS1260	+ \$0
18" x 60"	DS1860	+ \$0
24" x 60"	DS2460	+ \$0
30" x 60"	DS3060	+ \$0
<b>66" Wide Screens</b>		
12" x 66"	DS1266	+ \$0
18" x 66"	DS1866	+ \$0
24" x 66"	DS2466	+ \$0
30" x 66"	DS3066	+ \$0
<b>72" Wide Screens</b>		
12" x 72"	DS1272	+ \$0
18" x 72"	DS1872	+ \$0
24" x 72"	DS2472	+ \$0
30" x 72"	DS3072	+ \$0

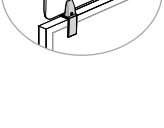
## 4. Mount

Mount Style	Code	Price	
<b>Protective/Privacy</b>			
Edge Mount Compatibility: 17"-54" Screen Width 12"-24" Screen Height	MT1	+ \$88	
Edge Mount Compatibility: 60"-72" Screen Width 12"-24" Screen Height	MT1	+ \$132	
Middle Mount Compatibility: 17"-29" Screen Width 12"-24" Screen Height	MT2	+ \$88	
Top Mount Compatibility: 17"-54" Screen Width 12"-24" Screen Height	MT3	+ \$56	
Top Mount Compatibility: 60"-72" Screen Width 12"-24" Screen Height	MT3	+ \$84	
Freestanding Mount Compatibility: 17"-54" Screen Width 12"-24" Screen Height	MT4	+ \$88	
Freestanding Mount Compatibility: 60"-72" Screen Width 12"-24" Screen Height	MT4	+ \$132	
Small Panel Mount Compatibility: 1.5"-2.3" Panel Depth 17"-54" Screen Width 12"-24" Screen Height	MT9	+ \$88	
Small Panel Mount Compatibility: 1.5"-2.3" Panel Depth 60"-72" Screen Width 12"-24" Screen Height	MT9	+ \$132	
Large Panel Mount Compatibility: 2.3"-3.7" Panel Depth 17"-54" Screen Width 12"-24" Screen Height	MT10	+ \$88	
Large Panel Mount Compatibility: 2.3"-3.7" Panel Depth 60"-72" Screen Width 12"-24" Screen Height	MT10	+ \$132	

## FABRIC WORKSURFACE SCREEN

## 4. Mount (Cont.)

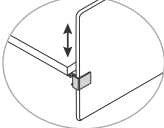
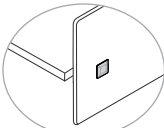
Mount Style	Code	Price	
<b>Protective/Privacy + Modesty</b>			
Height-Adjustable Mount Compatibility: 24"-60" Screen Width 24"-30" Screen Height	MT6	+ \$80	
Midway Mount Compatibility: 17"-54" Screen Width 24"-30" Screen Height	MT5	+ \$38	
Midway Mount Compatibility: 60"-72" Screen Width 24"-30" Screen Height	MT5	+ \$76	

12" x 23" Screen With Edge Mount





# Motif

## MOBILE + FREESTANDING FABRIC SCREENS

### *Distance with style.*

Now more than ever, our welcoming spaces should be safe—free from contagions, concern and anything that gets in the way of productivity. This collection of mobile and freestanding screens provides the protection and peace of mind you need to work with confidence.



**EFFECTIVE DECEMBER 1, 2021**

### Featured Models

#### **FREESTANDING :: \$922**

Freestanding screen with glides, 60" x 36", grade 1 fabric, triangular-shaped feet

#### **MOBILE :: \$1,102**

Mobile screen with casters, 60" x 36", grade 1 fabric, T-shaped feet

#### **LARGE MOBILE :: \$1,289**

Mobile screen with casters, 48" x 72", grade 1 fabric, T-shaped feet

## Features

- Mobile and freestanding screens are an easy-to-deploy solution for environments always in motion
- Quick installation creates safer, color-coordinated spaces in minutes
- Durable fabrics designed to heal from pins, thumbtacks and more
- Find privacy + protection with fabrics that are bleach-cleanable, helping protect against COVID-19
- Eco-friendly, single-piece construction features a Hexacore honeycomb center, providing rigidity with less weight
- Compact foot design allows for easy nesting and almost endless storing
- Black, silver or white frame finish
- Foot styles include freestanding with glides or mobile with casters

### 1. Product

Product Type	Code	Price
Mobile + Freestanding Screens	3092	Priced by Fabric Grade and Size

### 2. Material

Material Type	Code	Price		
Fabric/Vinyl	DT701	Priced by Fabric Grade and Size		
Fabric Grade	Code	Price		
30" Wide Screens		53" x 30"	60" x 30"	72" x 30"
Base Price		\$743	\$847	\$961
Fabric/Vinyl Grade 1	FG1/VG1	+ \$0	+ \$0	+ \$0
Fabric/Vinyl Grade 2	FG2/VG2	+ \$48	+ \$52	+ \$63
Fabric/Vinyl Grade 3	FG3/VG3	+ \$128	+ \$140	+ \$168
Fabric/Vinyl Grade 4	FG4/VG4	+ \$224	+ \$245	+ \$294
Fabric/Vinyl Grade 5	FG5/VG5	+ \$384	+ \$420	+ \$504
36" Wide Screens		53" x 36"	60" x 36"	72" x 36"
Base Price		\$829	\$922	\$1,011
Fabric/Vinyl Grade 1	FG1/VG1	+ \$0	+ \$0	+ \$0
Fabric/Vinyl Grade 2	FG2/VG2	+ \$48	+ \$52	+ \$63
Fabric/Vinyl Grade 3	FG3/VG3	+ \$128	+ \$140	+ \$168
Fabric/Vinyl Grade 4	FG4/VG4	+ \$224	+ \$245	+ \$294
Fabric/Vinyl Grade 5	FG5/VG5	+ \$384	+ \$420	+ \$504
42" Wide Screens		53" x 42"	60" x 42"	72" x 42"
Base Price		\$914	\$997	\$1,050
Fabric/Vinyl Grade 1	FG1/VG1	+ \$0	+ \$0	+ \$0
Fabric/Vinyl Grade 2	FG2/VG2	+ \$48	+ \$52	+ \$63
Fabric/Vinyl Grade 3	FG3/VG3	+ \$128	+ \$140	+ \$168
Fabric/Vinyl Grade 4	FG4/VG4	+ \$224	+ \$245	+ \$294
Fabric/Vinyl Grade 5	FG5/VG5	+ \$384	+ \$420	+ \$504
48" Wide Screens		53" x 48"	60" x 48"	72" x 48"
Base Price		\$997	\$1,073	\$1,109
Fabric/Vinyl Grade 1	FG1/VG1	+ \$0	+ \$0	+ \$0
Fabric/Vinyl Grade 2	FG2/VG2	+ \$48	+ \$52	+ \$63
Fabric/Vinyl Grade 3	FG3/VG3	+ \$128	+ \$140	+ \$168
Fabric/Vinyl Grade 4	FG4/VG4	+ \$224	+ \$245	+ \$294
Fabric/Vinyl Grade 5	FG5/VG5	+ \$384	+ \$420	+ \$504

Please reference the Textile Reference Guide for information on approved textiles for Motif products.

## MOBILE + FREESTANDING SCREEN

### 3. Size

Size (H" x W")	Code	Price
53" x 30"	DS5330	+ \$0
53" x 36"	DS5336	+ \$0
53" x 42"	DS5342	+ \$0
53" x 48"	DS5348	+ \$0
60" x 30"	DS6030	+ \$0
60" x 36"	DS6036	+ \$0
60" x 42"	DS6042	+ \$0
60" x 48"	DS6048	+ \$0
72" x 30"	DS7230	+ \$0
72" x 36"	DS7236	+ \$0
72" x 42"	DS7242	+ \$0
72" x 48"	DS7248	+ \$0

### 4. Base

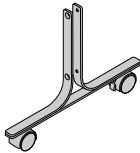
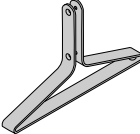
Base Design	Code	Price	
T-Shaped Foot	SF4	+ \$0	
Triangular-Shaped Foot	SF5	+ \$0	

Base Finish	Code	Price	
Silver	BF01	+ \$0	
White	BF02	+ \$0	
Black	BF03	+ \$0	

Mobility Options	Code	Price	
Glides	LS18	+ \$0	
Carpet Casters	LS19	+ \$180	

### SPECIFICATIONS

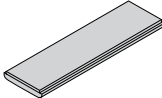
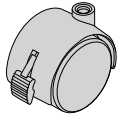
Model:	3092 Motif Mobile/Freestanding Screen
Screen Thickness	1"
Foot Height	0.63" (SF4+LS18), 3.25" (SF5+LS18) 2.75" (SF4+LS19), 5.5" (SF5+LS19)
Foot Length	16.38"
Foot Width	1.5"
Floor to Bottom of Screen	2.63" (LS18) 4.75" (SF4+LS19) 4.88" (SF5+LS19)

*Glides (LS18). Casters (LS19). T-shaped foot (SF4). Triangular-shaped foot (SF5).*



# Sector

## ACRYLIC WORKSURFACE SCREENS

### *Partition and protect.*

Now more than ever, our workspaces should be safe—free from distractions, contagions and anything that gets in the way of productivity. This collection of clear and frosted acrylic screens stands ready to provide the privacy, protection and peace of mind you need in a landscape where the way we interact changes every day.



30" x 48" Height-adjustable Frosted Acrylic Screen  
Table not included; see page 405 for Switchback 2-Leg.

**EFFECTIVE DECEMBER 1, 2021**

### Featured Models

**12" x 23" EDGE :: \$198**

12" x 23" frosted acrylic screen,  
edge mount

**30" x 48" HA :: \$579**

30" x 48" frosted acrylic screen,  
height-adjustable mount

**30" x 60" MIDWAY :: \$700**

30" x 60" clear acrylic screen,  
midway mount

### Features

- Frosted acrylic provides essential privacy while clear acrylic allows for safe social interactions
- High-performing, resilient acrylic surfaces can withstand some of the most powerful cleaners and disinfectants, including a full range of EPA-approved COVID-19 products
- Lightweight material offers greater resistance to impact compared to glass alternatives
- Height options include 12, 18, and 24 inches; 30 inches available for midway and height-adjustable table mounts
- Width options range from 17 to 72 inches (in six-inch increments)
- Compatible with most mounts, including edge, middle, top, midway, freestanding, panel and height-adjustable

### 1. Product

Product Type	Code	Price
Screen	3090	Priced by Size

### 2. Material

Material Type	Code	Price
Clear Acrylic	DT101C	Priced by Size
Frosted Acrylic	DT101	Priced by Size



### 3. Size

Screen Size (H x W)	Code	Price
<b>17" Wide Side Screens</b>		
12" x 17"	DS1217	\$81
18" x 17"	DS1817	\$111
24" x 17"	DS2417	\$147
<b>23" Wide Side Screens</b>		
12" x 23"	DS1223	\$110
18" x 23"	DS1823	\$166
24" x 23"	DS2423	\$198
<b>29" Wide Side Screens</b>		
12" x 29"	DS1229	\$139
18" x 29"	DS1829	\$207
24" x 29"	DS2429	\$251

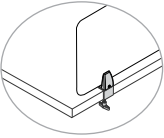
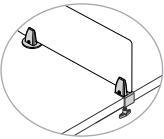
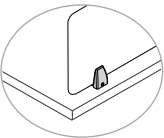
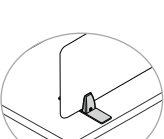
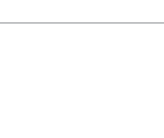
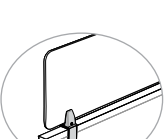

### 3. Size (Cont.)

Screen Size (H x W)	Code	Price
<b>24" Wide Screens</b>		
24" x 24"	DS2424	\$198
30" x 24"	DS3024	\$251
<b>30" Wide Screens</b>		
24" x 30"	DS2430	\$251
30" x 30"	DS3030	\$313
<b>36" Wide Screens</b>		
12" x 36"	DS1236	\$171
18" x 36"	DS1836	\$255
24" x 36"	DS2436	\$310
30" x 36"	DS3036	\$375
<b>42" Wide Screens</b>		
12" x 42"	DS1242	\$198
18" x 42"	DS1842	\$298
24" x 42"	DS2442	\$361
30" x 42"	DS3042	\$437
<b>48" Wide Screens</b>		
12" x 48"	DS1248	\$226
18" x 48"	DS1848	\$339
24" x 48"	DS2448	\$400
30" x 48"	DS3048	\$499
<b>54" Wide Screens</b>		
12" x 54"	DS1254	\$255
18" x 54"	DS1854	\$380
24" x 54"	DS2454	\$463
30" x 54"	DS3054	\$562
<b>60" Wide Screens</b>		
12" x 60"	DS1260	\$282
18" x 60"	DS1860	\$423
24" x 60"	DS2460	\$499
30" x 60"	DS3060	\$624
<b>66" Wide Screens</b>		
12" x 66"	DS1266	\$311
18" x 66"	DS1866	\$425
24" x 66"	DS2466	\$548
30" x 66"	DS3066	\$685
<b>72" Wide Screens</b>		
12" x 72"	DS1272	\$339
18" x 72"	DS1872	\$462
24" x 72"	DS2472	\$599
30" x 72"	DS3072	\$747

### 4. Mount

Mount Style	Code	Price	
<b>Protective/Privacy</b>			
Edge Mount Compatibility: 17"-54" Screen Width 12"-24" Screen Height	MT1	+ \$88	
Edge Mount Compatibility: 60"-72" Screen Width 12"-24" Screen Height	MT1	+ \$132	
Middle Mount Compatibility: 17"-29" Screen Width 12"-24" Screen Height	MT2	+ \$88	
Top Mount Compatibility: 17"-54" Screen Width 12"-24" Screen Height	MT3	+ \$56	
Top Mount Compatibility: 60"-72" Screen Width 12"-24" Screen Height	MT3	+ \$84	
Freestanding Mount Compatibility: 17"-54" Screen Width 12"-24" Screen Height	MT4	+ \$88	
Freestanding Mount Compatibility: 60"-72" Screen Width 12"-24" Screen Height	MT4	+ \$132	
Small Panel Mount Compatibility: 1.5"-2.3" Panel Depth 17"-54" Screen Width 12"-24" Screen Height	MT9	+ \$88	
Small Panel Mount Compatibility: 1.5"-2.3" Panel Depth 60"-72" Screen Width 12"-24" Screen Height	MT9	+ \$132	
Large Panel Mount Compatibility: 2.3"-3.7" Panel Depth 17"-54" Screen Width 12"-24" Screen Height	MT10	+ \$88	
Large Panel Mount Compatibility: 2.3"-3.7" Panel Depth 60"-72" Screen Width 12"-24" Screen Height	MT10	+ \$132	

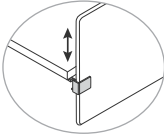
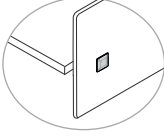
### 4. Mount (Cont.)

Mount Style	Code	Price	
<b>Protective/Privacy + Modesty</b>			
Height-Adjustable Mount Compatibility: 24"-60" Screen Width 24"-30" Screen Height	MT6	+ \$80	
Midway Mount Compatibility: 17"-54" Screen Width 24"-30" Screen Height	MT5	+ \$38	
Midway Mount Compatibility: 60"-72" Screen Width 24"-30" Screen Height	MT5	+ \$76	

# Sector

## MOBILE + FREESTANDING ACRYLIC SCREEN

### *Adaptable peace-of-mind.*

Now more than ever, our welcoming spaces should be safe—free from contagions, concern and anything that gets in the way of productivity. This collection of mobile and freestanding screens provides the protection and peace of mind you need to work with confidence.



**EFFECTIVE DECEMBER 1, 2021**

### Featured Models

#### **FREESTANDING :: \$950**

Freestanding screen with glides, 60" x 36", frosted acrylic, T-shaped feet

#### **MOBILE :: \$1,130**

Mobile screen with casters, 60" x 36", clear acrylic, T-shaped feet

#### **LARGE MOBILE :: \$1,309**

Mobile screen with casters, 48" x 72", clear acrylic, T-shaped feet

### Features

- Mobile and freestanding screens are an easy-to-deploy solution for environments always in in motion.
- Quick installation creates safer spaces in minutes
- High-performing, resilient acrylic can withstand some of the most powerful cleaners and disinfectants, including a full range of EPA-approved COVID-19 products
- Frosted acrylic provides privacy while clear acrylic offers unimpeded protection
- Lightweight material offers greater resistance to impact compared to glass alternatives
- Foot styles include freestanding with glides or mobile with casters
- Silver frame finish

### SPECIFICATIONS

	3092 Sector Freestanding/Mobile Screen
Screen Thickness	0.75"
Foot Height	0.63" (LS18), 2.63" (LS19)
Foot Length	16.38"
Foot Width	1"
Floor to Bottom of Screen	2.63" (LS18), 4.63" (LS19)

Glides (LS18). Casters (LS19)

### 1. Product

Product Type	Code	Price
Freestanding/Mobile Screen	3092	Priced by Size

### 2. Material

Material Type	Code	Price
Frosted Acrylic	DT101	Priced by Size
Clear Acrylic	DT101C	Priced by Size

### 3. Size

Screen Size	Code	Price
53" x 30"	DS5330	\$715
53" x 36"	DS5336	\$781
53" x 42"	DS5342	\$848
53" x 48"	DS5348	\$913
60" x 30"	DS6030	\$870
60" x 36"	DS6036	\$950
60" x 42"	DS6042	\$1,030
60" x 48"	DS6048	\$1,110
72" x 30"	DS7230	\$950
72" x 36"	DS7236	\$1,003
72" x 42"	DS7242	\$1,120
72" x 48"	DS7248	\$1,129

### 4. Base

Base Finish	Code	Price
Silver	BF01	+ \$0
White	BF02	+ \$0
Black	BF03	+ \$0



Mobility Options	Code	Price
Glides	LS18	+ \$0
Carpet Casters	LS19	+ \$180

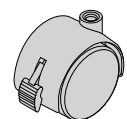
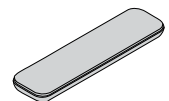



# Sector

## ACRYLIC SEATING SCREENS

### *Partition and protect.*

Now more than ever, our welcoming spaces should be safe—free from contagions, concern and anything that gets in the way of interacting. This collection of seating screens provides the privacy, protection and peace of mind you need to wait with confidence.



*Freelance*

**EFFECTIVE DECEMBER 1, 2021**

### Featured Models

#### **AVIERA :: \$477**

47" x 24" seating screen compatible with Aviera Guest, Aviera Patient, Aviera Freespan and Aviera Pre-Configured models

#### **FOCUS SIDE :: \$477**

47" x 24" seating screen compatible with Focus Side chairs. Not compatible with stools or casters

#### **FREELANCE :: \$477**



47" x 24" seating screen compatible with Freelance and Freelance Bariatric chair models. Not compatible with stools or casters

### Features

- Compatible with Aviera, Freelance and Focus Side
- Seating screens provide fixed, consistent distancing between each chair for safer spaces
- Patent-pending interlocking mount easily transforms current seating configurations while creating more efficient floor plans
- High-performing, resilient acrylic surfaces can withstand some of the most powerful cleaners and disinfectants, including a full range of EPA approved COVID-19 products
- Frosted acrylic provides privacy while clear acrylic allows for safe interactions
- Quick to ship and easy to integrate
- Silver and black bracket finishes

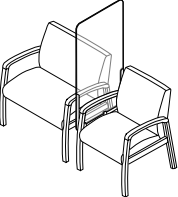

### 1. Product

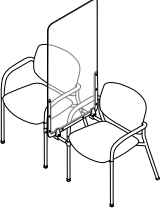
Model	Code	Price	
Screens for Aviera	3097 VRX	\$477	
Screens for Focus Side	3097 56X	\$477	
Screens for Freelance	3097 52X	\$477	

### 2. Material

Material Type	Code	Price	
Clear Acrylic	DT101C	+ \$0	
Frosted Acrylic	DT101	+ \$0	

## ACRYLIC SEATING SCREEN

### 3. Size

Screen Size	Code	Price
47" x 24"	DS4724	+\$0

### 4. Finish

Bracket Finish	Code	Price
Black	BKF03	+\$0
Silver	BKF01	+\$0

### 5. Replacements

Parts	Code	Price
Screen	Frame and Screen	\$290
Interlocking Bracket Kit For Focus Side	Complete Bracket	\$187
Interlocking Bracket Kit For Freelance	Complete Bracket	\$187
Interlocking Bracket Kit For Aviera	Complete Bracket	\$187

### SPECIFICATIONS

Model:	3097 VRX Seating Screen for Aviera	3097 56X Seating Screen for Focus Side	3097 52X Seating Screen for Freelance
Screen Size	46.5" x 23.5"	46.5" x 23.5"	46.5" x 23.5"
Chair Gap (A) Armless	—	9.5"	10"
Chair Gap (A) With Arms	5.3"	5.7"	6"
From Chair to Screen (B) Armless	—	4.5"	4.75"
From Chair to Screen (B) With Arms	2.4"	2.6"	2.75"
Height to Base of Interlocking Assembly (C)	12.4"	11.3"	11.3"
Height From Floor to Top of Screen (D)	60"	60"	60"
Two Guest Chairs With Screen (E)	54.3"	54.7"	57"
Three Guest Chairs With Screens (F)	84.1"	84.9"	88.5"
Four Guest Chairs With Screens (G)	113.9"	115.1"	120"
Screen Thickness	0.75"	0.75"	0.75"

See the diagram below for assistance with measurements.

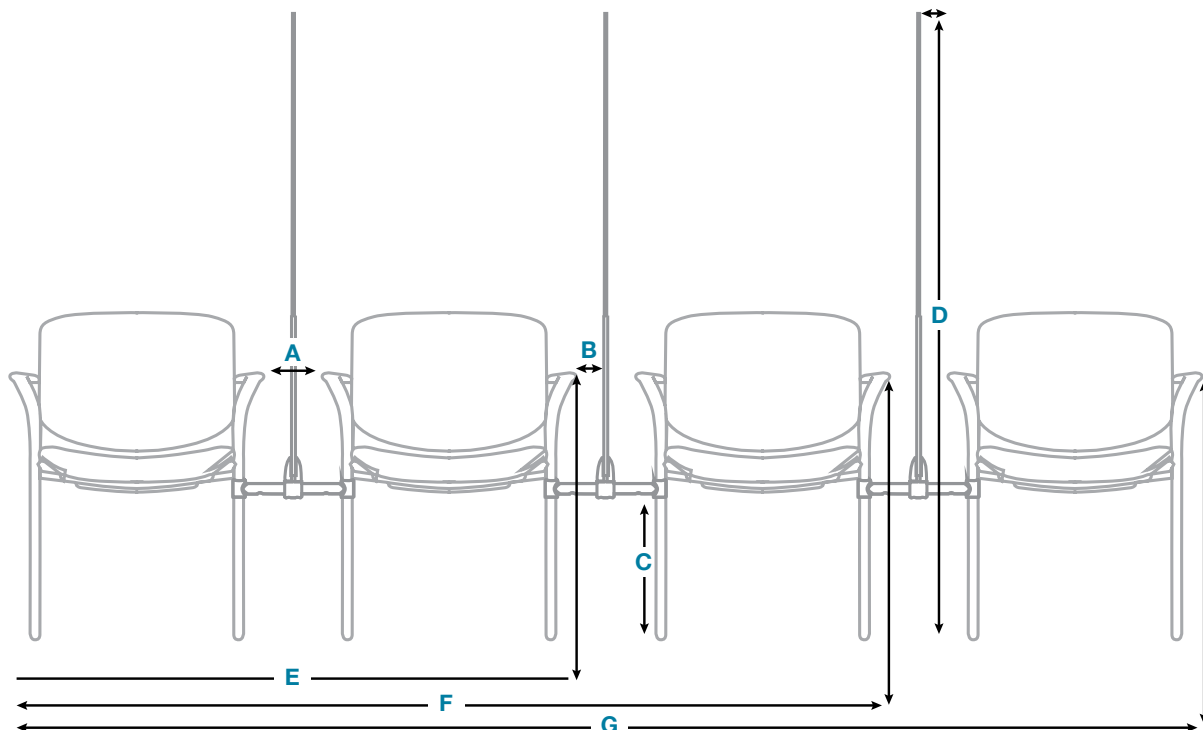

# Sector

## ACRYLIC CAFÉ SCREENS

### *Partition and protect.*

Partition and protect. Now more than ever, our shared spaces should be safe—free from contagions, concerns and anything that gets in the way of interacting. This collection of acrylic tabletop screens provides the protection and peace of mind you need to socialize with confidence.



**EFFECTIVE DECEMBER 1, 2021**

### Featured Models

#### **2-PERSON :: \$363**

2-person screen for 30 x 30" round table,  
30" screen height

#### **4-PERSON :: \$1,076**

4-person screen for 48" square table,  
30" screen height

### Features

- Clear acrylic allows for safe social interactions
- High-performing, resilient acrylic surfaces can withstand some of the most powerful cleaners and disinfectants, including a full range of EPA-approved COVID-19 products
- Lightweight material offers greater resistance to impact compared to glass alternatives
- 2-Person café table is available with three different foot styles

### 1. Product

Product Type	Code	Price
Tabletop Screen	3096	Priced by Size

Screen Type	Code	Price
Café Round	CRSC	Priced by Size
Café Square	CSSC	Priced by Size

### 2. Material

Material Type	Code	Price
Clear Acrylic	DT101C	Priced by Size



### 3. Size

Screen Height	Code	Price	
Screen Height, 24"	SCH24	Priced by Table Size	
Screen Height, 30"	SCH30	Priced by Table Size	

Table Size	Code	Price	
<b>2-Person Café Screen</b>		<b>24"</b>	<b>30"</b>
24" Round	TR2424	\$258	\$310
30" Round	TR3030	\$303	\$363
24" Square	TS2424	\$258	\$310
30" Square	TS3024	\$303	\$363
<b>4-Person Café Screen</b>		<b>24"</b>	<b>30"</b>
36" Round,	TR3636	\$428	\$509
42" Round	TR4242	\$472	\$552
48" Round	TR4848	\$514	\$565
36" Square	TS3636	\$729	\$969
42" Square	TS4242	\$802	\$1,022
48" Square	TS4848	\$882	\$1,076

### 4. Feet (2-Person Only)

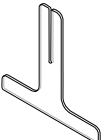
Foot Style	Code	Price	
Round-Shaped	SF1	+\$0	
T-Shaped	SF2	+\$0	
Square-Shaped	SF3	+\$0	

# Sector

## ACRYLIC TRANSACTION SCREEN

### *Partition and protect.*

Partition and protect. Now more than ever, our shared spaces should be safe—free from contagions, concerns and anything that gets in the way of interacting. This collection of acrylic tabletop screens provides the protection and peace of mind you need to interact with confidence.



**EFFECTIVE DECEMBER 1, 2021**

### Featured Models

**PASS-THROUGH :: \$351**

24" x 36" acrylic screen, pass-through, round feet

**NO PASS-THROUGH :: \$351**

24" x 36" acrylic screen, no pass-through, round feet

### Features

- 1-on-1 transaction screens sit ready to protect during quick interactions and small get togethers
- Quick and easy tabletop installation means you can provide protection in seconds
- Clear acrylic allows for safe social interactions
- High-performing, resilient acrylic surfaces can withstand some of the most powerful cleaners and disinfectants, including a full range of EPA-approved COVID-19 products.
- Lightweight material offers greater resistance to impact compared to glass alternatives.
- Available with three different foot styles
- Option a 4" tall pass-through

#### 1. Product

Product Type	Code	Price
Tabletop Screen	3096	Priced by Size

Screen Type	Code	Price
Transaction	TRSC	Priced by Size

#### 2. Material

Material Type	Code	Price
Clear Acrylic	DT101C	Priced by Size

#### 3. Size

Size (H x W)	Code	Price
<b>24" Width</b>		
24" x 24"	SCH24 SCW24	\$258
30" x 24"	SCH30 SCW24	\$310
36" x 24"	SCH36 SCW24	\$356
42" x 24"	SCH42 SCW24	\$381
<b>30" Width</b>		
24" x 30"	SCH24 SCW30	\$303
30" x 30"	SCH30 SCW30	\$363
36" x 30"	SCH36 SCW30	\$389
42" x 30"	SCH42 SCW30	\$445

#### 3. Size (Cont.)

Size (H x W) (Cont.)	Code	Price
<b>36" Width</b>		
24" x 36"	SCH24 SCW36	\$351
30" x 36"	SCH30 SCW36	\$374
36" x 36" (Coming Soon)	SCH36 SCW36	\$411
42" x 36"	SCH42 SCW36	\$480
<b>48" Width</b>		
24" x 48"	SCH24 SCW48	\$389
30" x 48"	SCH30 SCW48	\$408
36" x 48" (Coming Soon)	SCH36 SCW48	\$428
42" x 48"	SCH42 SCW48	\$518

#### 4. Appearance

Foot Style	Code	Price
Round-Shaped	SF1	+ \$0
T-Shaped	SF2	+ \$0
Square Shaped	SF3	+ \$0

Pass-Through	Code	Price
No Pass-Through	NPT	+ \$0
Pass-Through	PTI	+ \$0

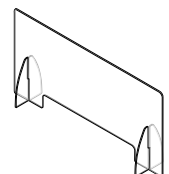
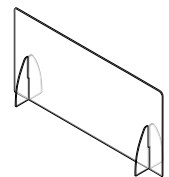
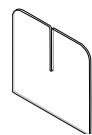
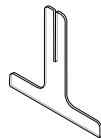

# Sector

## TRI-FOLD ACRYLIC MEETING AND SINGLE-TABLE SCREEN

### *Partition and protect.*

Partition and protect. Now more than ever, our shared spaces should be safe—free from contagions, concerns and anything that gets in the way of interacting. This collection of acrylic tabletop screens provides the protection and peace of mind you need to meet with confidence.

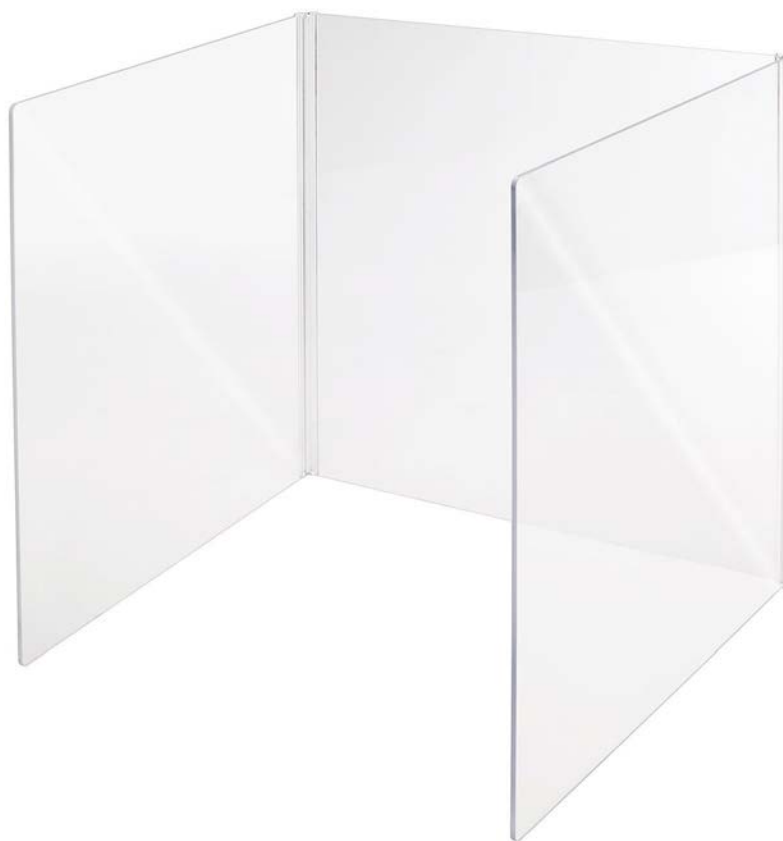

**EFFECTIVE DECEMBER 1, 2021**

### Featured Models

#### **SINGLE TABLE :: \$532**

24" x 48" tri-fold acrylic single-table screen, 24" height

#### **MEETING :: \$1,151**

20" x 58" tri-fold acrylic meeting screen, 30" height



## TRI-FOLD ACRYLIC MEETING AND SINGLE-TABLE SCREEN

### Features

- From individual desks to large board rooms, tri-fold meeting screens are personal, mobile and adapt to the busy classroom or office easily
- Single-table tri-fold screens conveniently match common tabletop sizes; tri-fold meeting screens allow you to subdivide larger meeting tables.
- High-performing, resilient acrylic surfaces can withstand some of the most powerful cleaners and disinfectants, including a full range of EPA-approved COVID-19 products.
- Clear acrylic allows for safe social interactions
- Lightweight material offers greater resistance to impact compared to glass alternatives.

### 1. Product

Product Type	Code	Price
Tabletop Screen	3096	Priced by Size
Product Style	Code	Price

Tri-Fold Screen

TFSC

Priced by Size

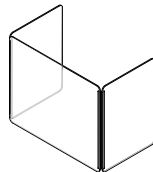

### 2. Material

Material	Code	Price
Clear Acrylic	DT101C	Priced by Size

### 3. Size

Table Size (D x W)	Code	Price
<b>Tri-Fold Single-Table, 24" Height</b>		
18" x 48"	SCH24 SCW46 SCD17	\$424
18" x 60"	SCH24 SCW58 SCD17	\$705
24" x 48"	SCH24 SCW46 SCD23	\$532
24" x 60"	SCH24 SCW58 SCD23	\$813
30" x 48"	SCH24 SCW46 SCD29	\$595
30" x 60"	SCH24 SCW58 SCD29	\$895
<b>Tri-Fold Single-Table, 30" Height</b>		
18" x 48"	SCH30 SCW46 SCD17	\$699
18" x 60"	SCH30 SCW58 SCD17	\$1,027
24" x 48"	SCH30 SCW46 SCD23	\$878
24" x 60"	SCH30 SCW58 SCD23	\$1,288
30" x 48"	SCH30 SCW46 SCD29	\$898
30" x 60"	SCH30 SCW58 SCD29	\$1,443
<b>Tri-Fold Meeting, 24" Height</b>		
17" x 29"	SCH24 SCW29 SCD17	\$401
17" x 46"	SCH24 SCW46 SCD17	\$424
17" x 58"	SCH24 SCW58 SCD17	\$705
20" x 29"	SCH24 SCW29 SCD20	\$415
20" x 46"	SCH24 SCW46 SCD20	\$476
20" x 58"	SCH24 SCW58 SCD20	\$774
23" x 29"	SCH24 SCW29 SCD23	\$430
23" x 46"	SCH24 SCW46 SCD23	\$532
23" x 58"	SCH24 SCW58 SCD23	\$813
29" x 29"	SCH24 SCW29 SCD29	\$446
<b>Tri-Fold Meeting, 30" Height</b>		
17" x 29"	SCH30 SCW29 SCD17	\$601
17" x 46"	SCH30 SCW46 SCD17	\$699
17" x 58"	SCH30 SCW58 SCD17	\$1,027
20" x 29"	SCH30 SCW29 SCD20	\$672
20" x 46"	SCH30 SCW46 SCD20	\$818
20" x 58"	SCH30 SCW58 SCD20	\$1,151
23" x 29"	SCH30 SCW29 SCD23	\$753
29" x 29"	SCH30 SCW29 SCD29	\$807

*On single-table tri-fold screens, the screen depth is 1" less than the table's depth and 2" shorter than the table width.*

*For instance: A 24" x 48" Tabletop has a screen with an actual size of 23" x 46".*

**MEETING TABLE COMPATIBILITY CHART**

Screen Size (D x W)	Code	Seats Supported
<b>36" x 72" Conference Table</b>		
17" x 29"	SCH24 SCW29 SCD17	2 Seats Per Side
17" x 46"	SCH24 SCW46 SCD17	1 Seat Per Side
17" x 58"	SCH24 SCW58 SCD17	1 Seat Per Side
<b>42" x 84" Conference Table</b>		
20" x 29"	SCH24 SCW29 SCD20	2 Seats Per Side
20" x 46"	SCH24 SCW46 SCD20	1 Seat Per Side
20" x 58"	SCH24 SCW58 SCD20	1 Seat Per Side
<b>48" x 96" Conference Table</b>		
23" x 29"	SCH24 SCW29 SCD23	3 Seats Per Side
23" x 46"	SCH24 SCW46 SCD23	2 Seats Per Side
23" x 58"	SCH24 SCW58 SCD23	1 Seat Per Side
29" x 29"	SCH24 SCW29 SCD29	1 Seat Per Side

# Monitor Arms

SINGLE POLE | DUAL POLE | TRIPLE POLE  
SINGLE DESK | DUAL DESK  
HEAVY DUTY | DUAL ARRAY

# Statement of Line

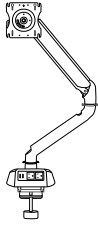

**King Cobra**  
Light Duty Single Screen Arm  
3101 MAT02..... 512

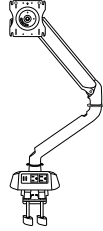

**King Cobra**  
Heavy Duty Single Screen Arm  
3101 MAT02..... 512

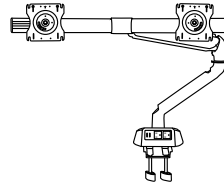

**King Cobra**  
Heavy Duty Dual Array  
3101 MAT03..... 512

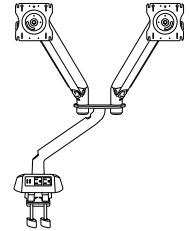

**King Cobra**  
Heavy Duty Dual Screen High-Splitter  
3101 MAT04..... 512

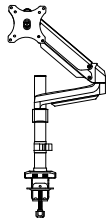

**Mobio**  
Single Pole Monitor Arm  
3210 MAT30..... 514

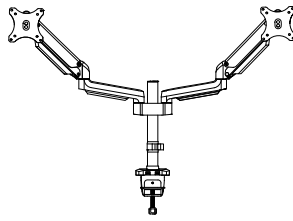

**Mobio**  
Dual Pole Monitor Arm  
3210 MAT31..... 514

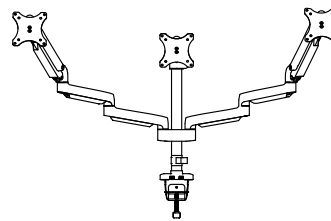

**Mobio**  
Triple Pole Monitor Arm  
3210 MAT32..... 514

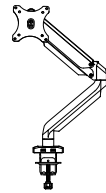

**Mobio**  
Single Desk Monitor Arm  
3210 MAT33..... 514

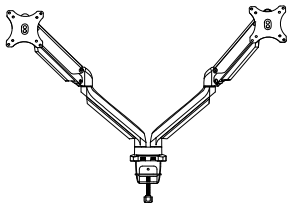

**Mobio**  
Dual Desk Monitor Arm  
3210 MAT34..... 514

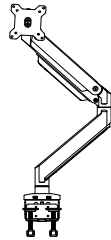

**Mobio**  
Heavy Duty Single Desk Monitor Arm  
3210 MAT35..... 514

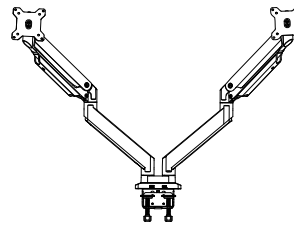

**Mobio**  
Heavy Duty Dual Desk Monitor Arm  
3210 MAT36..... 514

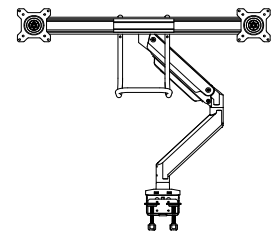

**Mobio**  
Heavy Duty Dual Array Monitor Arm  
3210 MAT37..... 514

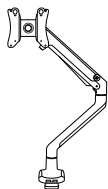

**Unity G2**  
Single  
3111 MAT06..... 517

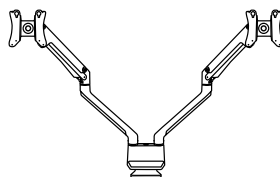

**Unity G2**  
Dual  
3111 MAT07..... 517

# King Cobra

MONITOR ARM

*Charmed by design.*

Strike at the heart of productivity with the King Cobra collection of monitor arms. Sleek design, smooth operation, unmatched performance and rugged reliability combine to meet the demands of today's modern office.



*Dual Screen High-Splitter*  
*Table not included. See page 410 for Switchback.*

**EFFECTIVE DECEMBER 1, 2021**

## Featured Models

**SINGLE SCREEN :: \$601**

Light duty single screen monitor arm

**DUAL SCREEN HIGH-SPLITTER :: \$878**

Heavy duty dual screen high splitter monitor arm

### Features

- Die-cast aluminum construction provides greater stability and contains high-recycled material
- A variety of foldable, gas-type arms in light duty, heavy duty and high-splitter configurations
- Portrait and landscape view-adjustable quick-release VESA
- Available in four configurations: Single, HD Single, HD Dual Array and HD Dual High Splitter
- Features two power and two USB outlets
- Adjustable rotation limiter helps restrict arm rotation to 180 degrees
- Includes clamp and grommet mount
- Installs easily with clamp mount and 10-ft power cord

### SPECIFICATIONS: SINGLE SCREEN

Model:	MAT01 Light Duty Single Screen	MAT02 Heavy Duty Single Screen
Height	7.63"-22.13"	7.63"-22.13"
Max Arm Extension	24.75"	24.75"
Table Top Thickness	0.39"-1.62"	0.39"-1.62"
VESA	75 mm, 100 mm	75 mm, 100 mm
Power Outlet	120 V	120 V
USB Port	5 V 2.1 Amp	5 V 2.1 Amp
Weight Capacity Warranty	5-20 lb	10-30 lb

### SPECIFICATION: DUAL SCREEN

Model:	MAT03 Heavy Duty Dual Array	MAT M04 Heavy Duty Dual Screen High-Splitter
Height	8.43"-22.93"	7.93"-22.43"
Max Arm Extension	29.77"	13.67"
Top Table Thickness	0.39"-1.62"	0.39"-1.62"
VESA	75 mm, 100 mm	75 mm, 100 mm
Power Outlet	120 V	120 V
USB Port	5 V 2.1 Amp	5 V 2.1 Amp
Max Monitor Width	23"	27"
Weight Capacity Warranty (Per Screen)	6-28 lb	10-30 lb

### 1. Product

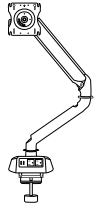
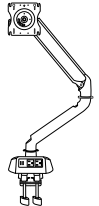
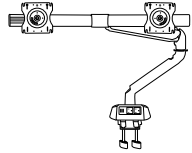
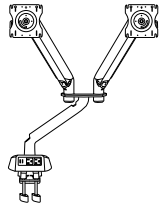
Product Type	Code	Price	
Light Duty Single Screen	3101 MAT01 MAC01	\$601	
Heavy Duty Single Screen	3101 MAT02 MAC01	\$631	
Heavy Duty Dual Array	3101 MAT03 MAC01	\$703	
Heavy Duty Dual Screen High-Splitter	3101 MAT04 MAC01	\$878	

### 2. Slider

Product Type	Code	Price	
Monitor Arm Slider	MAT00	Priced by Style	
Product Style	Code	Price	
Single Slider	MAA01	\$129	
Dual Sliders	MAA02	\$256	

# Mobio

## MONITOR ARM

### *Experience unmatched performance.*

When you're hard at work, you need a workspace that works hard for you. With a wide range of motion and ultra-reliability, Mobio is your go-to solution for a family of monitor arms to maximize your space. Its compact design and die cast aluminum construction mean greater stability, flexibility and unmatched performance.



*Dual Desk Monitor Arm  
Table not included. See page 417 for Switchback.*

**EFFECTIVE DECEMBER 1, 2021**

### Featured Models

**SINGLE DESK :: \$272**

Mobio single desk monitor arm

**DUAL DESK :: \$543**

Mobio dual desk monitor arm

**DUAL ARRAY HD :: \$630**

Mobio heavy duty dual array monitor arm

## Features

- Includes surface clamp and grommet mount, ideal for all desk mounting configurations
- Choose from Mobio arms in single desk, dual desk and pole-mount configurations
- Choose from Mobio HD arms in single desk, dual desk and dual-array configurations
- Compact aluminum arm design maximizes desktop space
- Die-cast aluminum construction ensures stability and performance
- Gas spring mechanism delivers smooth vertical adjustment
- Built-in spring tension gauge enables perfect weight adjustment
- Installs easily with quick-release VESA plate
- Two pass-through USB ports come standard



## MONITOR ARM

### 1. Product

Product Style	Code	Price	
<b>Mobio</b>			
Single Pole Monitor Arm	3210 MAT30	\$346	
Dual Pole Monitor Arm	3210 MAT31	\$624	
Triple Pole Monitor Arm	3210 MAT32	\$724	
Single Desk Monitor Arm	3210 MAT33	\$272	
Dual Desk Monitor Arm	3210 MAT34	\$543	
<b>Mobio HD</b>			
Heavy Duty Single Desk Monitor Arm	3210 MAT35	\$424	
Heavy Duty Dual Desk Monitor Arm	3210 MAT36	\$951	
Heavy Duty Dual Array Monitor Arm	3210 MAT37	\$630	



## 2. Accessories

Options	Code	Price
No Accessories	MAA00	+ \$0
Laptop Tray	MAA03	+ \$99

## 3. Monitor Arm Finish

Paint Color	Code	Price
Silver	MAC01	+ \$0
Black	MAC03	+ \$0

HD models are available in silver (MAC01) finish only.

## SPECIFICATIONS: POLE ARMS

	MAT30 Single Pole	MAT31 Dual Pole	MAT32 Triple Pole
Max Monitor Size	17"-32"	17"-32"	17"-27"
Max Arm Extension	23.16"	21.3"	28.58"
Table Top Thickness	0.39"-2.17"	0.39"-2.17"	0.39"-2.17"
Pole Height	12.58"	12.58"	18.09"
VESA	75 mm 100 mm	75 mm 100 mm	75 mm 100 mm
Weight Capacity (Per Screen)	3.3-17.6 lb	3.3-17.6 lb	3.3-17.6 lb

## MONITOR ARM

### SPECIFICATIONS: DESK ARMS

	MAT33 Single Desk	MAT34 Dual Desk
Max Monitor Size	17"-32"	17"-32"
Max Arm Extension	20.72"	20.72"
Height Range	5.31"-16.34"	5.31"-16.34"
Table Top Thickness	0.39"-2.17"	0.39"-2.17"
VESA	75 mm 100 mm	75 mm 100 mm
Weight Capacity (Per Screen)	3.3-17.6 lb	3.3-17.6 lb

### SPECIFICATIONS: HEAVY DUTY ARMS

	MAT35 Single Desk HD	MAT36 Dual Desk	MAT37 Dual Array
Max Monitor Size	17"-35"	17"-35"	17"-32"
Max Extension	23.49"	23.49"	12.68"
Height Range	10.03"-23.03"	10.03"-23.03"	10.43"-23.43"
Table Top Thickness	0.39"-2.04"	0.39"-2.04"	0.39"-2.04"
VESA	75 mm 100 mm	75 mm 100 mm	75 mm 100 mm
Weight Capacity (Per Screen)	2.2-33 lb	2.2-33 lb	2.2 lb-17.6 lb

# Unity G2

MONITOR ARM

*Altogether powerful.*

Be one with your work. Our Unity G2 family of monitor arms combine reliable utility with rugged design to create the perfect solution for any workspace.



*Single Monitor Arm*  
*Table not included. See page 432 for Tensor.*

**EFFECTIVE DECEMBER 1, 2021**

## Featured Models

**SINGLE :: \$301**

Unity G2 single monitor arm, white finish

**DUAL :: \$600**

Unity G2 dual monitor arm, silver finish

### Features

- Gas height-adjustable
- 12 inches of lift
- 180-degree pan and 360-degree rotation

### 1. Monitor Arms

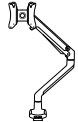
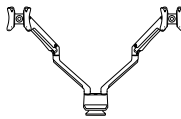
Product Type	Code	Price	
Single	3111 MAT06	\$301	
Dual	3111 MAT07	\$600	

### 2. Monitor Arm Finish

Paint Color	Code	Price
Silver	MAC01	+ \$0
White	MAC02	+ \$0

### SPECIFICATIONS

	3111 MAT06 Single-Monitor	3111 MAT07 Dual-Monitor
Max Screen Size	N/A	17" – 29"
Max Extension	20.92"	20.92"
Height Range	6.9"–18.9"	7.6"–19.4"
VESA	75 mm, 100 mm	75 mm, 100 mm
Table Top Thickness	0.39"–1.5"	0.39"–1.5"
Weight Capacity (Per Arm)	4.4–17.6 lb	4.4–17.6 lb

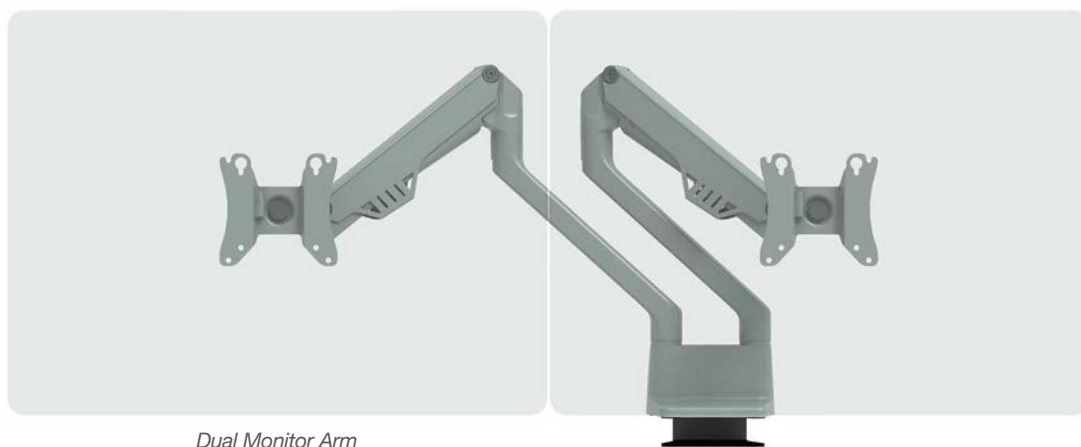

# Accessories

STORAGE | POWER | LIGHTING  
KEYBOARD TRAY | WIRE MANAGEMENT  
DESKTOP SIT-TO-STAND  
ANTI-FATIGUE MAT

# Anti-Fatigue Mat

EFFECTIVE  
DECEMBER 1, 2021

## *Soft and supportive.*

Promote well-being while ensuring productivity. Our anti-fatigue mat help you stand (and work) longer—pairing well with our collections of height-adjustable tables and desktop workstations.

### Anti-Fatigue Mat

Product	Code	Price	
20" x 30" Black Anti-Fatigue Mat	3153 AFM01	\$188	

## Features and Specifications

- Provides premium ergonomic comfort
- Can reduce fatigue from standing up to 50%
- Durable single-piece construction
- 100% polyurethane integral skin design
- 20" (D) x 30" (W)
- 5-year warranty



# CPU Storage

EFFECTIVE  
DECEMBER 1, 2021

## Keep it clean.

Secure your PC with ease. Our CPU holder that attaches to your workstation for a cleaner look.

*CPU Under Desk/Wall Mount*



*CPU Storage Band*



## CPU Storage

Product	Code	Price	
CPU Storage Band	3156 CPUS1	\$251	
CPU Under Desk/Wall Mount	3156 CPUS3	\$126	

## Features and Specifications

### BAND

- Supports most PC sizes (up to 64" in perimeter)
- Retracts on a 17" track with 360-degree swivel
- Quick and easy adjustments with an Allen key
- Weight capacity warranty: Up to 75 lb

### UNDER DESK/WALL

- Slide-and-swivel movement makes adjustment easy
- Features a 17" track
- Supports sizes 3.75"-10.5" (W) × 16.5"-24" (H)

# Keyboard Tray

GSA SIN #: 33721  
EFFECTIVE  
DECEMBER 1, 2021

## Lift, tuck and type.

Free up your workspace with our collection of convenient keyboard platforms and platform connectors.

Mini Trackless With Lift and Lock Mechanism



## Features and Specifications

### LIFT AND LOCK

- Lift and lock provides 7 inches of height adjustment
- Includes knob for manual tilt adjustment
- 21.75" track

### PREMIUM LIFT AND LOCK

- Lift and lock height adjustment with automatic tilt adjustment
- Patented height and tilt indicator
- 21.75" track

### MINI TRACKLESS

- Designed to attach and function without a track
- Easily attaches below top to avoid crossbar interference

### SIT-TO-STAND

- Lift and lock height adjustment with height range from 8" above the track to 6" below
- Control for tilt adjustment
- 23" track

## 1. Keyboard Tray

Product Type	Code	Price
Keyboard Tray	3151	\$0

## 2. Mechanism

Mechanism	Code	Price
None	KBM00	\$0
HAT	KBM01	\$134
Lift and Lock	KBM02	\$225
Mini Trackless	KBM04	\$290
Premium Lift and Lock	KBM05	\$307
Sit-to-Stand	KBM06	\$395

## 3. Platform

Platform Style	Code	Price
None	KBP00	+ \$0
Laptop Tray	KBP01	+ \$137
Longboard	KBP02	+ \$239
Mini Platform	KBP03	+ \$287
Crescent Board	KBP04	+ \$279
Tilt, Swivel Board	KBP05	+ \$267

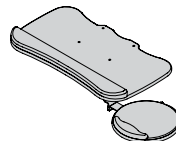
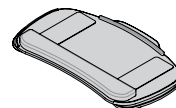
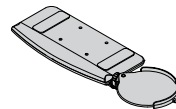
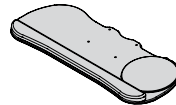
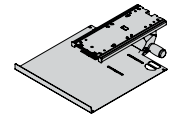

## 4. Miscellaneous

Options	Code	Price
None	KBO00	+ \$0
U-Brackets for Crossrails	KBTA	+ \$100
Corner Sleeve	KBCS	+ \$177

# Laptop Storage

GSA SIN #: 33721  
EFFECTIVE  
DECEMBER 1, 2021

## Support and store.

Declutter, declutter. If you're tight on space or need to shift gears, our laptop storage is your go-to solution for an extra hand. These add-ons install under your desk and adjusts left to right to fit your work needs.



Laptop Drawer

## 1. Product

Product Style	Code	Price	
Laptop Drawer	3154 LPT01	\$360	
Laptop Tray	3154 LPT02	\$270	

## Features and Specifications

### LAPTOP DRAWER

- 18.28" (W) × 22.28" (L) × 3.64" (H)
- Steel construction
- Enough space to also accommodate a docking station

### LAPTOP TRAY

- Adjusts left to right to fit in tight places
- Includes mechanism, track and mounting hardware
- Platform: 15" (W) × 15" (L)
- Desk attachment: 5.77" (W) × 12.75" (L)
- Available in black finish only



# Rhythm

EFFECTIVE  
DECEMBER 1, 2021

## LIGHTING

### *A bright idea.*

Promote bright ideas at every workstation with our value series lighting. It's sleek, simple and turns on with the wave of a hand.



28" Rhythm Lighting

### SPECIFICATIONS

<b>Model:</b>	3140 Lighting
<b>Dimensions With Mounts</b>	
Height	1.80"
Length	28.07"
Depth	1.81"
Interconnecting Cable Length	5'
Power Cord Length	6'
<b>Electrical</b>	
Color Temperature	2800 K
LED-Rated Lifespan	50,000 Hours

### 1. Product

Product Type	Code	Price	
Lighting	3140	\$271	

Product Style	Code	Price	
28" Standard	LSV LFSV	+ \$0	
28" Daisy Chain Starter	LSV LFDV	+ \$69	

### 2. Add-On Light Fixtures

Quantity	Code	Price	
None	LFAV0	+ \$0	
One 28" Daisy Chain	LFAV1	+ \$235	
Two 28" Daisy Chain Starters	LFAV2	+ \$469	

### 3. Motion Sensor

Sensor	Code	Price	
None	LMS0	+ \$0	
Lighting With Motion Sensor	LMS1	+ \$118	

## Features

- Motion-activated power button
- Built-in 12-hour automatic shut-off feature
- Mounts allow for infinite tilt adjustment for focusing the light
- Dimmer: 3 settings; motion-activated
- Brightness adjustability: 100%–50% in 3 stages
- Color finish: silver aluminum with black end caps
- Housing material: clear anodized aluminum
- Both wood screws and magnet mounts included

# Mobile Pedestal

STORAGE SOLUTION

## *File with flexibility.*

Our two-drawer mobile pedestal stores everything you need and can move out of the way while still being within reach.

*Mobile Pedestal With Upholstered Pad*



**EFFECTIVE DECEMBER 1, 2021**

## Featured Models

### **NO UPHOLSTERED PAD :: \$320**

Mobile pedestal, silver finish, no upholstered pad

### **WITH UPHOLSTERED PAD :: \$446**

Mobile pedestal, white finish, upholstered pad, grade 1 textile

# MOBILE PEDESTAL

EFFECTIVE DECEMBER 1, 2021

## STORAGE SOLUTION

### Features

- Five base wheels provide easy mobility
- Recessed pulls mean flat surfaces for safer work areas
- Optional cushion with colorful upholstery options
- Full extension drawer slides
- Compatible with legal and letter file sizes
- Silver, black and white finish options
- Drawer tested at 50,000 pull cycles

### 1. Product

Product Type	Code	Price
Mobile Pedestal	3150	\$320

  

Product Style	Code	Price
---------------	------	-------

No Upholstered Pad      CPT00      + \$0

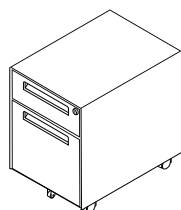

Upholstered Pad      CPT01      + \$126

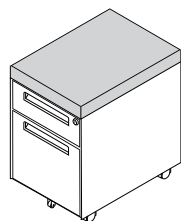

### 2. Pedestal Finish

Paint Color	Code	Price
Silver	PDC01	+ \$0
White	PDC02	+ \$0
Black	PDC03	+ \$0

### 3. Material

Material Grade	Code	Price
Fabric/Vinyl Grade 1	FG1	+ \$0
Fabric/Vinyl Grade 2	FG2	+ \$11
Fabric/Vinyl Grade 3	FG3	+ \$30
Fabric/Vinyl Grade 4	FG4	+ \$52
Fabric/Vinyl Grade 5	FG5	+ \$90
Fabric/Vinyl Grade 6	FG6	+ \$127
Fabric/Vinyl Grade 7	FG7	+ \$165

### SPECIFICATIONS

	3150 Mobile Pedestal
Height	19.25"
Width	14.25"
Length	19.625"
Cushion Height	1.8"
Drawer Weight Capacity	88 lb
Stationary Weight Capacity (Including Weight of Drawer Contents)	250 lb



Mobile Pedestal With No Upholstered Pad

# Pencil Storage

EFFECTIVE  
DECEMBER 1, 2021

## Store and more.

When it comes to storing pens, pencils and more, our supply drawers are the "write" way to go—keeping everything organized and within reach.



Half Moon Pencil Drawer

## Features

- Divided storage compartments for pens, pencils and other small supplies
- Includes easy-to-follow assembly instructions

### 1. Product

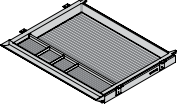
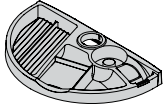
Product Style	Code	Price	
Rectangular Pencil Drawer	3155 PDT01	\$129	
Half Moon Pencil Drawer	3155 PDT02	\$109	

### SPECIFICATIONS

Model:	3155 PDT01 Rectangular Pencil Drawer	WM01 Half Moon Pencil Drawer
Dimensions		
Height	1.94"	1.35"
Width	18.125"	8.23"
Length	22.75"	13.6"
Drawer Extension	11.5"	11.5"

# Current

POWER

GSA SIN #: 33721  
EFFECTIVE  
DECEMBER 1, 2021

## Plug into productivity.

Our Current power module provides the charge you need to stay on task all day long.



Current Surface Camp Mount

### 1. Current Collection

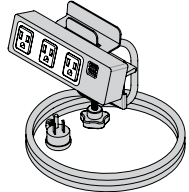
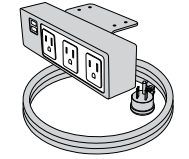
Product Type	Code	Price	
Surface Clamp Mount	3130 PCC	\$244	
Undermount Bracket	3130 PCU	\$281	

### 2. Color

Module and Cord Color	Code	Price	
White	PC4	+\$0	
Black	PC1	+\$0	

## Features and Specifications

- Three outlets, 2 USB ports
- White finish features 3.1 amp; black finish comes with 2.1 amp
- Convenient tablet or phone holder built into clamp mount
- 15 amp, 125 volt
- Cord: 10 feet
- Surge protection: 510 joules
- Two USB charging ports; 3.1A combined
- UL/cUL listed (UL962A)

## Empower your workspace.

Charge up (to keep up) with your day ahead. EON eliminates the struggle of finding an outlet with an easily accessible power source right at your fingertips. Keep your devices ready for any task with this line of convenient power modules.



Single Outlet, Dual USB

### 1. EON Collection

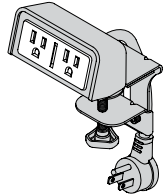
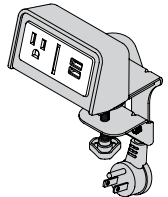
Product Type	Code	Price	
EON Clamp On, Dual Outlet	3130 PTC PT5	\$112	
EON Clamp On, Single Outlet, Dual USB	3130 PTC PT2	\$163	

### 2. Color

Module and Cord Color	Code	Price	
White	PC4	+ \$0	
Black	PC1	+ \$0	

## Features

- Choose from dual-outlet or single-outlet/dual-USB setups
- AC outlet: 15A, 125V, 60Hz
- Quick-charge USB outlets: 3.1A, 5V
- Add an easy-to-access power source at worksurface level
- Installs with surface mount clamp
- Includes 8' power cord that is UL-listed

# High Tide

EFFECTIVE  
DECEMBER 1, 2021

## SIT-TO-STAND

### *Elevate your task.*

Our High Tide offers an easy-to-install solution for converting desktops into an adaptable sit-to-stand, height-adjustable workstation.



High Tide 4

## Features

- Infinite height-adjustment increments with lockable gas spring and a height-adjustable range of up to 19.25"
- Desktop size is 17.8" (W) x 32.5" (L);  
Keyboard tray size is 6.6" (W) x 32.25" (L);  
Overall size is 25.04" (W) x 32.62" (L)
- Desktop supports up to 33 lb;  
Keyboard tray supports 4.4 lb
- Single monitor arm weight limit is 20 lb;  
Dual monitor arm weight limit is 10 lb per monitor
- Dual monitor arm supports screens up to 22" (W)
- Single monitor arm pole is 12.59" (H);  
Dual monitor arm pole is 16.59" (H)
- Desktop material is HDF with CARB certification

### 1. High Tide

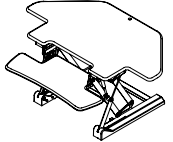
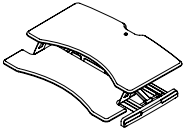
Model	Code	Price	
High Tide Corner Unit	3120 SSHT1	\$598	
High Tide 4	3120 SSHT4	\$504	

### 2. Monitor Arms

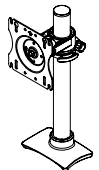
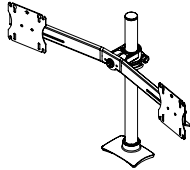
Sit/Stand Monitor Arm	Code	Price	
None	MAT00	+ \$0	
Single Screen	MAT25	+ \$318	
Dual Screen	MAT26	+ \$386	



High Tide Corner Unit

# Cable Caddy

WIRE MANAGEMENT

EFFECTIVE  
DECEMBER 1, 2021

GSA SIN #: 33721  
3152 WM01, 3152 WM03, AND 3152 WM02 ONLY

*Clear the cable clutter.*

## Features

### CABLE CADDY

- Fully enclosed design conceals cable clutter
- Sturdy steel construction
- Generous amount of space in caddy opening
- Optional 8-outlet power strip

### CABLE CADDY BASKET

- Control cables while maintaining easy access to wires
- Steel wire construction with powdercoated paint
- Black or Silver finish options
- Optional 8-outlet power strip

### CABLE CADDY CLIPS

- Includes three wire management pieces
- Place these clips anywhere you need cable control
- Easy installation with four screws



### CABLE CADDY SLIM

- Simple cable management solution
- Lightweight polymer construction
- Easily attaches to any smooth surface with included adhesive tape

## SPECIFICATIONS

Model:	WM03 Cable Caddy	WM05 Cable Caddy Basket	WM01 Cable Caddy Slim
<b>Dimensions</b>			
Height	6"	6"	1.13"
Length	36"	26"	49"
Depth	4"	6"	2.5"

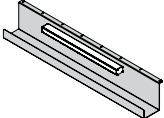
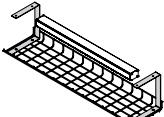
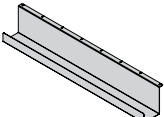
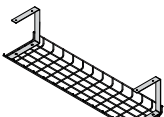
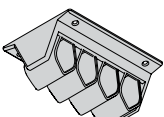
## 1. Wire Management and Power Strip Add-Ons

Product Type	Code	Price	
<b>Power Strip</b>			
Power Strip	3152 PST1 WM00	\$191	
<b>Wire Management With Power</b>			
Cable Caddy + Power	3152 PST1 WM03	\$347	
Cable Caddy Basket + Power	3152 PST1 WM05	\$276	
<b>Wire Management Without Power</b>			
Cable Caddy	3152 WM03	\$156	
Cable Caddy Basket	3152 WM05	\$85	
Cable Caddy Clips	3152 WM01	\$71	
Cable Caddy Slim	3152 WM02	\$55	
Color	Code	Price	
Black	WMC03	+ \$0	
Silver	WMC01	+ \$0	

*Color options available on cable caddy basket (WM05) only.*



# Appendix

HELPFUL REFERENCE MATERIAL

# STAND-ALONE TABLETOPS

GSA SIN #: 33721

## 1. Table or Desk Top

Product Type	Code	Price
Tabletop or Desktop	3000	Priced by Size

## 2. Size

Top Size	Code	Price	
Depth x Width	Round		

42" TR4242 \$366

48" TR4848 \$414

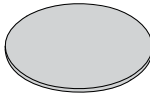

Depth x Width	Square		
---------------	--------	--	--

30" x 30" TS3030 \$246

36" x 36" TS3636 \$282

42" x 42" TS4242 \$319

48" x 48" TS4848 \$360

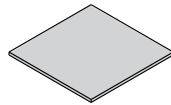

Depth x Width	Right 90-Degree Top		
---------------	---------------------	--	--

24" x 48" TBCR2448 \$460

24" x 54" TBCR2454 \$517

24" x 60" TBCR2460 \$573

30" x 48" TBCR3048 \$573

30" x 54" TBCR3054 \$648

30" x 60" TBCR3060 \$716

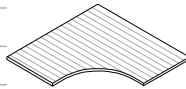

Depth x Width	Left 90-Degree Top		
---------------	--------------------	--	--

24" x 48" TBCL2448 \$460

24" x 54" TBCL2454 \$517

24" x 60" TBCL2460 \$573

30" x 48" TBCL3048 \$573

30" x 54" TBCL3054 \$648

30" x 60" TBCL3060 \$716

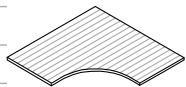

Depth x Width	120-Degree Top		
---------------	----------------	--	--

24" x 42" TA2442 \$626

24" x 48" TA2448 \$807

30" x 42" TA3042 \$654

30" x 48" TA3048 \$816

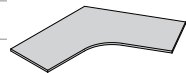

Actual size of 30" x 30" tabletop is 30.75" x 30.75"

## 2. Size (Cont.)

Top Size	Code	Price	
Depth x Width	Standard Rectangular		

18" x 42" TZ1842 \$156

18" x 48" TZ1848 \$177

18" x 54" TZ1854 \$200

18" x 60" TZ1860 \$220

18" x 66" TZ1866 \$244

18" x 72" TZ1872 \$266

20" x 36" TZ2036 \$145

20" x 42" TZ2042 \$168

20" x 48" TZ2048 \$193

20" x 54" TZ2054 \$226

20" x 60" TZ2060 \$240

20" x 66" TZ2066 \$265

20" x 72" TZ2072 \$287

24" x 36" TZ2436 \$174

24" x 42" TZ2442 \$203

24" x 48" TZ2448 \$231

24" x 54" TZ2454 \$259

24" x 60" TZ2460 \$287

24" x 66" TZ2466 \$318

24" x 72" TZ2472 \$345

24" x 78" TZ2478 \$374

24" x 84" TZ2484 \$402

30" x 36" TZ3036 \$217

30" x 42" TZ3042 \$253

30" x 48" TZ3048 \$287

30" x 54" TZ3054 \$325

30" x 60" TZ3060 \$359

30" x 66" TZ3066 \$395

30" x 72" TZ3072 \$430

30" x 78" TZ3078 \$467

30" x 84" TZ3084 \$502

42" x 78" TZ4278 \$651

42" x 84" TZ4284 \$701

42" x 90" TZ4290 \$764

42" x 96" TZ4296 \$800

48" x 78" TZ4878 \$744

48" x 84" TZ4884 \$800

48" x 90" TZ4890 \$879

48" x 96" TZ4896 \$914

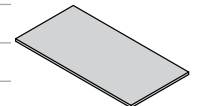

# STAND-ALONE TABLETOPS

GSA SIN #: 33721

## 2. Size (Cont.)

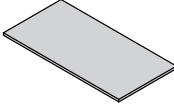
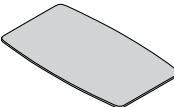
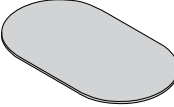
Top Size	Code	Price		
<b>Depth x Width</b>	<b>Rectangular for Use with eBEAM (-2")</b>			
24" x 46"	TZ2446	\$231		
24" x 58"	TZ2458	\$287		
24" x 70"	TZ2470	\$345		
30" x 46"	TZ3046	\$287		
30" x 58"	TZ3058	\$359		
30" x 70"	TZ307	\$430		
<b>Depth x Width</b>	<b>Wide Boat</b>			
42" x 78"	TB4278	\$651		
42" x 84"	TB4284	\$701		
42" x 90"	TB4290	\$764		
42" x 96"	TB4296	\$800		
48" x 78"	TB4878	\$744		
48" x 84"	TB4884	\$800		
48" x 90"	TB4890	\$879		
48" x 96"	TB4896	\$914		
<b>Depth x Width</b>	<b>Wide Boat</b>			
42" x 78"	TK4278	\$651		
42" x 84"	TK4284	\$701		
42" x 90"	TK4290	\$764		
42" x 96"	TK4296	\$800		
48" x 78"	TK4878	\$744		
48" x 84"	TK4884	\$800		
48" x 90"	TK4890	\$879		
48" x 96"	TK4896	\$914		

## 2. Size (Cont.)

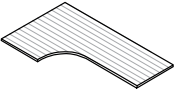
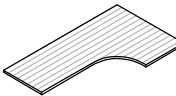
Top Size	Code	Price	
<b>A x B x C</b>	<b>Right Extended Corner</b>		
24" x 36" x 60"	TXR243660	\$431	
24" x 36" x 66"	TXR243666	\$486	
24" x 36" x 72"	TXR243672	\$549	
24" x 42" x 60"	TXR244260	\$495	
24" x 42" x 66"	TXR244266	\$559	
24" x 42" x 72"	TXR244272	\$631	
24" x 48" x 60"	TXR244860	\$544	
24" x 48" x 66"	TXR244866	\$615	
24" x 48" x 72"	TXR244872	\$694	
30" x 36" x 60"	TXR303660	\$495	
30" x 36" x 66"	TXR303666	\$559	
30" x 36" x 72"	TXR303672	\$676	
30" x 42" x 60"	TXR304260	\$569	
30" x 42" x 66"	TXR304266	\$642	
30" x 42" x 72"	TXR304272	\$726	
30" x 48" x 60"	TXR304860	\$598	
30" x 48" x 66"	TXR304866	\$676	
30" x 48" x 72"	TXR304872	\$764	
<b>A x B x C</b>	<b>Left Extended Corner</b>		
24" x 60" x 36"	TXL246036	\$431	
24" x 66" x 36"	TXL246636	\$486	
24" x 72" x 36"	TXL247236	\$549	
24" x 60" x 42"	TXL246042	\$495	
24" x 66" x 42"	TXL246642	\$559	
24" x 72" x 42"	TXL247242	\$631	
24" x 60" x 48"	TXL246048	\$544	
24" x 66" x 48"	TXL246648	\$615	
24" x 72" x 48"	TXL247248	\$694	
30" x 60" x 36"	TXL306036	\$495	
30" x 66" x 36"	TXL306636	\$559	
30" x 72" x 36"	TXL307236	\$676	
30" x 60" x 42"	TXL306042	\$569	
30" x 66" x 42"	TXL306642	\$642	
30" x 72" x 42"	TXL307242	\$726	
30" x 60" x 48"	TXL306048	\$598	
30" x 66" x 48"	TXL306648	\$676	
30" x 72" x 48"	TXL307248	\$764	

# STAND-ALONE TABLETOPS

## 2. Size (Cont.)

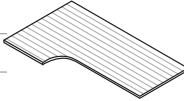
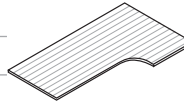
Top Size	Code	Price		
<b>A x B x C x D</b>	<b>Right Extended Offset Corner</b>			
24" x 36" x 60" x 30"	OR24366030	\$472		
24" x 36" x 66" x 30"	OR24366630	\$537		
24" x 36" x 72" x 30"	OR24367230	\$609		
24" x 42" x 60" x 30"	OR24426030	\$547		
24" x 42" x 66" x 30"	OR24426630	\$620		
24" x 42" x 72" x 30"	OR24427230	\$705		
24" x 48" x 60" x 30"	OR24486030	\$576		
24" x 48" x 66" x 30"	OR24486630	\$653		
24" x 48" x 72" x 30"	OR24487230	\$742		
<b>A x B x C x D</b>	<b>Left Extended Offset Corner</b>			
30" x 60" x 36" x 24"	OL30603624	\$472		
30" x 66" x 36" x 24"	OL30663624	\$537		
30" x 72" x 36" x 24"	OL30723624	\$609		
30" x 60" x 42" x 24"	OL30604224	\$547		
30" x 66" x 42" x 24"	OL30664224	\$620		
30" x 72" x 42" x 24"	OL30724224	\$705		
30" x 60" x 48" x 24"	OL30604824	\$576		
30" x 66" x 48" x 24"	OL30664824	\$653		
30" x 72" x 48" x 24"	OL30724824	\$742		

## 3. Top Finish

Laminate	Code	Price	
Ankara Cherry	TL18	+ \$0	
Black	TL19	+ \$0	
Brazilian Walnut	TL20	+ \$0	
Cabinet Maple	TL21	+ \$0	
Driftwood	TL23	+ \$0	
Folkstone Grey	TL24	+ \$0	
Libretti	TL25	+ \$0	
Queenston Oak	TL26	+ \$0	
Sandalwood	TL27	+ \$0	
Walnut Amati	TL28	+ \$0	
White	TL29	+ \$0	

## 4. Grommets

Grommet Location	Code	Price	
No Grommets	GP00	+ \$0	
Left Only	GP01	+ \$30	
Center Only	GP02	+ \$30	
Right Only	GP03	+ \$30	
Left and Center	GP04	+ \$60	
Left and Right	GP05	+ \$60	
Right and Center	GP06	+ \$60	
Left, Right and Center	GP07	+ \$90	
Grommet Color	Code	Price	
Black	GC01	+ \$0	
White	GC02	+ \$0	

Left grommets (GP01/GP04/GP05/GP07) are not available on right extended corners or right extended offset corners.

Right grommets (GP03/GP05/GP06/GP07) are not available on left extended corners or right extended offset corners.

## 5. Add-Ons

Mending Plate	Code	Price	
None	TTMP0	+ \$0	
Mending Plate Kit	TTMP1	+ \$74	
Stiffener	Code	Price	
No Stiffener	STF00	+ \$0	
54" Stiffener (1 Each)	STF01	+ \$80	
54" Stiffeners (2 Each)	STF02	+ \$160	

Mending plate kits are available with tabletops that have a depth of 20", 24" or 30".

Stiffeners are available with and recommended for tabletops that have a depth of 42" or more and/or a width of 66" or more.

# HEAVY DUTY SERIES GUIDE

## Heavy Duty Guide

SitOnIt Seating Heavy Duty Series offers an unmatched combination of strength, comfort and ergonomic support to accommodate various users, all at a value-driven price point, in addition to standard two-, five- and 10-day lead times.

The models in the Heavy Duty series include heavy duty task and side models that are rated up to a 350 lb, 400 lb, 500 lb or 1,000 lb capacity. These models feature expert construction that allow for 24-hour multi-shift usage.

### LIMITED 10-YEAR WARRANTY

SitOnIt Seating warrants the Heavy Duty Series for a period of 10 years when configured to the appropriate model. Fabric and foam cushioning are covered for two years.

### TEXTILE DURABILITY

SitOnIt Seating recommends textiles that are high-density and abrasion-resistant, with at least a 75,000 double rub rating.



#### Task

Weight Capacity	Up to 300 lb (Standard)	Up to 350 lb (Heavy Duty)	Up to 400 lb (Large and Tall)	Up to 500 lb (Extra Large)
Models	Amplify, Focus, Focus 2.0, Knack, Mavic, Novo, Prava, ReAlign, Sona, Torsa, TR2, Vectra, Wit	Task Chairs: Focus, Glove Active, Knack, ReAlign, TR2 Task Stools: Non-Stop Heavy Duty Stool, TR2	Novo, Amplify, Focus	Non-Stop
Seat Width	Standard	Standard	22"	23"
Back Width	Standard	Standard	Standard	22"
Warranty	Lifetime Single-Shift Amplify, Novo, Torsa, Wit: 12-Year Multi-Shift	10-Year Multi-Shift	10-Year Multi-Shift	10-Year Multi-Shift



#### Side

Weight Capacity	Up to 350 lb	Up to 500 lb	Up to 600 lb	Up to 750 lb	Up to 1000 lb
Models	Freelance Heavy Duty	Cora Guest 30" Freelance Bariatric	Cora Midsize	Cora Bariatric	42" Freelance Bariatric
Seat Width	19.5"	Cora Guest: 18.75" Freelance Bariatric: 30"	25.75"	29.5"	42"
Back Width	19.5"	Cora Guest: 19" Freelance Bariatric: 30"	27.5"	30"	42"
Warranty	10-Year Multi-Shift	Cora Guest: Lifetime Single-Shift or 12-Year Multi-Shift Freelance Bariatric: 10-Year Multi-Shift	10-Year Multi-Shift	10-Year Multi-Shift	10-Year Multi-Shift

# HEAVY DUTY SERIES GUIDE

## Large and Tall

SitOnIt Seating Large and Tall (LT) models are available as a standard to provide a fully coordinated and cohesive family offering on our Amplify, Focus and Novo task chairs. Large and Tall accommodates users up to 400 lb and SitOnIt Seating warrants for a period of 10 years used in multi-shift (24/7) applications.

Specify Large and Tall models by using the LT suffix when ordering. Add the appropriate additional charge for each chair. The list below summarizes the model, arm styles, mechanism, frame, back and base options.



### Large and Tall (LT) Models

Large and Tall Options (List Price)	Amplify 2723 B1 Y A152 LT	Focus 5623 B1 Y A152 LT	Novo 1033 BK2 Y A152 LT
LT Base Model: Highback, Black Frame, Enhanced Synchro, Height-Adjustable With Sport Arm Pads	\$1,011	\$1,060	\$971
<b>1. Arm Styles</b>			
Height-Adjustable With Sport Arm Pads (A152)	+ \$0	+ \$0	+ \$0
Armless (A0)	- \$48	- \$90	- \$48
Height-/Width-Adjustable With Sport Arm Pads (A153)	+ \$30	+ \$25	+\$30
<b>2. Seat Depth</b>			
Seat Depth Adjustment (E3)	+ \$79	+ \$79	+ \$79
<b>3. Frame</b>			
Back Support Color	Black (FC1)	Black (Z1) or Silver (Z2)	Black (FC1)
<b>4. Back</b>			
Upholstered Back (B3)	+ \$55	N/A	N/A
Upholstered Pad (B4)	N/A	+ \$126	N/A
Adjustable Lumbar (LB1)	+ \$0	+ \$50	+ \$0
<b>5. Base</b>			
Polished Aluminum Base (B5)	+ \$167	+ \$167	+ \$167
Heavy Duty Hard Floor and Carpet Casters (C9)	+ \$61	+ \$61	+ \$61
High Heavy Duty Cylinder (S13)	+ \$0	+ \$0	+ \$0

# STACKING GUIDE

Discover stacking compatibility with Sitonit Seating's multipurpose products—including a list of SitOnIt models with a wall-saver frame.

## 4-Leg

Collection	Plastic Seat and Back	Upholstered Seat With Plastic Back	Upholstered Seat and Back	Wall-Saver Frame
<b>On Cart</b>				
Achieve (Glides Only)	—	5	5	•
Anytime (Glides Only)	8	8	8	
Baja (Glides Only)	10	8	8	
Cora Guest (Glides Only)	—	—	6	•
Freelance (Glides Only)	6	6	6	•
InFlex (Glides Only)	12	Arms NR, 10 Armless	Arms NR, 10 Armless	
Lumin (Glides Only)	8	6	6	
Mika (Glides Only)	12	12	—	
Relay (Glides Only)	5	5	5	•
Rio (Glides Only)	8	7	7	
<b>On Floor</b>				
Achieve (Casters and Glides)	—	4	4	•
Anytime (Glides Only)	6	6	6	
Baja (Casters and Glides)	6	4	4	
Cora Guest (Casters and Glides)	—	—	4	•
Freelance (Casters and Glides)	4	4	4	•
InFlex (Casters and Glides)	5	Arms NR, 5 Armless	Arms NR, 5 Armless	
Lumin (Casters and Glides)	6	4	4	
Mika (Casters and Glides)	3	9	—	
Relay (Glides Only)	5	5	5	•
Rio (Casters and Glides)	4	3	3	

## 4-Leg Mesh

Collection	Plastic Seat Mesh Back	Upholstered Seat With Mesh Back	Fully Upholstered Seat and Back	Wall-Saver Frame
<b>On Cart</b>				
Focus Side (Glides Only)	—	5	3	•
Wit Side (Glides Only)	4	4	4	•
<b>On Floor</b>				
Focus Side (Glides or Casters)	—	4	3	•
Wit Side (Glides or Casters)	4	NR	NR	•

Freelance sled base and bariatric models are not stackable. Relay nester stacks three on the floor; vertical. Ioniq and Qwiz do not stack.

Please note that chairs with a tablet arm do not stack. Chairs with casters do not stack on a cart.

Please use caution when stacking models with casters to prevent frame damage. SitOnIt Seating does not warrant scratched frames.

NR — Not recommended.

# STACKING GUIDE

## Wire Rod

Collection	Plastic Seat and Back	Upholstered Seat With Plastic Back	Upholstered Seat and Back	Wall-Saver Frame
<b>On Cart</b>				
Baja (Glides Only)	6	4	4	
Lumin (Glides Only)	15	6	6	
Mika	30	12	—	
OnCall (Glides Only)	20 With Arms, 25 Armless	NR	NR	•
Orbix	25	NR	—	
Rio (Glides Only)	15	6	6	
Rowdy (Glides Only)	25 With Arms, 40 Armless	NR	NR	
Sprout	40	—	—	
<b>On Floor</b>				
Baja	6	6	6	
Lumin	8	4	4	
Mika	3	6	—	
OnCall	8	NR	NR	•
Orbix	6	NR	—	
Rio	6	5	5	
Rowdy	10 With Arms, 15 Armless	NR	NR	
Sprout	10	—	—	

## Stool

Collection	Plastic Seat and Back	Upholstered Seat With Plastic Back	Upholstered Seat and Back	Wall-Saver Frame
<b>On Floor</b>				
Baja	4	4	4	
Mika	3	3	—	
OnCall	4	NR	NR	•
Orbix	6	NR	—	

Freelance sled base and bariatric models are not stackable. Focus Side wood back models are not stackable. Relay nester stacks three on the floor; vertical. Ioniq and Qwiz do not stack.

Please note that chairs with a tablet arm do not stack. Chairs with casters do not stack on a cart.

Please use caution when stacking models with casters to prevent frame damage. SitOnIt Seating does not warrant scratched frames.

NR — Not recommended.



# GLIDE GUIDE

For almost 25 years, SitOnIt Seating products have been expertly designed to provide the best comfort and support in the industry.

Glides are an often overlooked element in the seating specification process, but they play a crucial role in ensuring proper interface between the chair and the floor.

This application guide offers general guidelines to assist customers with choosing the best glide for their needs. The guide is based on extensive lab testing and hands-on experience with selling chairs in a variety of environments, as well as review and consultations with glide experts.

## Application Guide

Material		Surfaces						
Glide Type (4-Leg)		Carpet	VCT	Vinyl	Laminate	Ceramic Tile	Hardwood	Concrete
Standard Multi-Surface Glides	Applies to Anytime,	Acceptable	Acceptable	Acceptable	Better	Better	NR	Better
Performance Multi-Surface Glides	Baja, Cora, Freelance,	Best	Better	Better	Better	Best	Better	Better
Floor Saver Glides	Focus Side, InFlex, Lumin,	NR	Best	Best	Best	NR	Best	Best
Steel Glides (Carpet Only)	Rio and Wit Side	Better	NR	NR	NR	NR	NR	NR

Material		Surfaces						
Glide Type (Wire Rod)		Carpet	VCT	Vinyl	Laminate	Ceramic Tile	Hardwood	Concrete
No Glides	Applies to Baja, Lumin,	Best	NR	NR	NR	NR	NR	NR
Clear Glides	Mika, OnCall, Orbix, Rio,	NR	NR	Acceptable	Better	Better	NR	Acceptable
Clear Glides With Felt	Rowdy and Sprout	NR	Better	Better	Best	NR	Better	NR

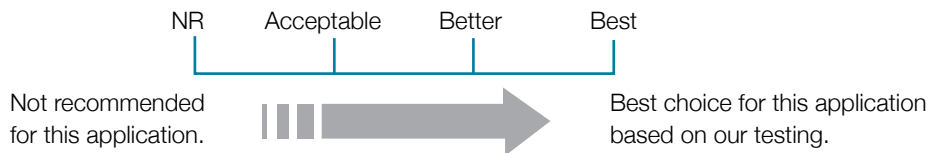

- **BEST:** Best choice for this application based on our testing.
- **BETTER:** Better choice for this application based on our testing.
- **ACCEPTABLE:** Acceptable choice for this application based on our testing but consider BETTER or BEST options.
- **NR:** Not recommended for this application based on our testing.

*This Application Guide is provided for informational purposes only. Always follow the manufacturer's instructions for care and maintenance of your flooring. Periodic inspection and maintenance of glides is critical to minimize the risk of damage to your flooring, especially when using glides with floors that are prone to scratching and marring. Testing was performed under simulated conditions. Because a wide range of factors impact actual performance, including how your chairs are used; the state of the glides and flooring; and dirt, moisture and other environmental factors, Exemplis does not warrant you will achieve any specific result. Actual results may vary.*

## Safety First

To ensure proper cleaning and/or disinfecting, it's important to consult with facilities or safety personnel and follow the manufacturer's instructions—including detailed dilution requirements, safe application instructions, dwell time for effective disinfecting and more.

Per CDC instructions, always read and follow the directions on the label to ensure safe and effective use.

- Wear skin protection and consider eye protection for potential splash hazards
- Ensure adequate ventilation
- Use no more than the amount recommended on the label
- Use water at room temperature for dilution (unless stated otherwise on the label)
- Avoid mixing chemical products
- Label diluted cleaning solutions
- Store and use chemicals out of the reach of children and pets

Always read and follow the directions on the cleaner/disinfectant labels to ensure safe and effective use.

## Clean + Disinfect

Cleaning and disinfecting are two distinct actions, and knowing the difference between the two can help promote safety in any space. This comprehensive, 2-step process requires cleaning before disinfecting.

## Clean

### CLEANING REMOVES GERMS

- The act of removing visible dirt and debris from objects or surfaces
- Cleaning works by using soap/detergent with water to remove impurities from surfaces either manually or mechanically
- Cleaning does not kill germs, but by removing them, it lowers their numbers and risk of spreading infection

## Clean (Cont.)

### CLEANING GUIDELINES AND TIPS

- Start by lightly dusting with a soft, grit-free cloth or chamois (no wiping)
- After dusting, dampen cloth or chamois with a solution of mild, non-abrasive liquid soap and water
- Wipe clean and dry with a soft, grit-free cloth, sponge or chamois
- Avoid using abrasive cleaners and steel wool to prevent scratching
- Test any cleaning method or agent in an inconspicuous area of the surface

## Disinfect

### DISINFECTING KILLS GERMS

- This process comes after a surface is cleaned
- Disinfecting kills germs on objects or surfaces with the use of chemicals
- Most common disinfectants include one of the following active ingredients: Quaternary Ammonium (Quats), Sodium Hypochlorite (Bleach), Hydrogen Peroxide, or 70% Isopropyl Alcohol
- EPA-registered disinfectants List N: Disinfectants for Use Against SARS-CoV-2

### DISINFECTING GUIDELINES AND TIPS

- Follow the disinfectant manufacturer's instructions when applying the agent
- Once finished, remove all disinfecting agents from the surface with water and a grit-free cloth, then dry
- If not properly removed, disinfectant residue could degrade product life and appearance

Cleaning + Disinfecting efforts should be part of an organization's comprehensive systems-based approach to provide a safe and sustainable workspace.

## Cleaning Our Hard Surfaces

Over 95% of the hard surfaces on our products can be cleaned/disinfected using any one of the four primary ingredients listed below.

- Bleach (Sodium Hypochlorite)
- Hydrogen Peroxide
- Quaternary Ammonium Compounds (Quats)
- 70% Isopropyl Alcohol

### EXAMPLES OF HARD SURFACES THAT CAN BE DISINFECTED:

- Plastics (i.e. polyurethane and acrylic)
- Solid Surface
- Metals
- Painted Surfaces
- Laminate

### EXCEPTIONS:

- Markerboard
- Veneer
- Wood Surfaces

## Clean + Disinfect

Cleaning and disinfecting are two distinct actions, and knowing the difference between the two can help promote safety in any space. This comprehensive, 2-step process requires cleaning before disinfecting.

## Cleaning Our Soft Surfaces

Our textiles and meshes offer a performance and cleaning story unmatched in the industry.

Our Carded Textile Program offers over 700 bleach-cleanable fabrics through our SitOnIt Seating private label and partnership textile program.

### MESH:

- All of our mesh materials are bleach-cleanable. This determination is supported by 3rd-party results from completing AATCC 188 Colorfastness to Bleach testing where the subject material is submerged, and friction stirred in a diluted sodium hypochlorite solution.
- Cleaning of our mesh materials varies. Check out the [Mesh Spec + Care Guide](#) on our website for more information.

### SEATING FABRICS:

- Soft surfaces on seating can vary widely from woven, knits and leather to coated textiles such as vinyl and polyurethane. Woven and knits tend to be more permeable than vinyl or polyurethane.
- Cleaning of our seating fabric materials varies. For a list of our textile spec + care guides, see the [Materials Downloads](#) on our website.
- For a list of bleach-cleanable materials, see our [Carded Library](#) and select "Bleach Cleanable" under performance.

### SCREEN FABRICS:

- Cleaning of screen materials varies. For a list of our textile spec + care guides, see the [Materials Downloads](#) on our website.
- For a list of bleach-cleanable materials, see our [Carded Library](#) and select "Bleach Cleanable" under performance.

# COLOR PROGRAM

From plastic shell colors to mesh colors to custom match colors, SitOnIt Seating gives designers and specifiers lots of options. The table below shows the color options available by collection. All plastic shell colors are available with a 2-day lead time for production.

## Plastics

	Anytime	Baja	Freelance	Ioniq	InFlex	Lumin	Mika	OnCall	Orbix	Relay	Qwiz	Rio	Rowdy	Sprout	Wit Side
Apple	—	SC24	—	—	—	SC24	—	—	SC24	—	—	SC24	SC24	—	—
Arctic	SC21	SC21	SC21	—	SC21	SC21	—	—	SC21	SC21	—	SC21	SC21	SC21	—
Black	SC1	SC1	SC1	SC1	SC1	SC1	SC1	SC1	SC1	SC1	SC1	SC1	SC1	SC1	SC1
Bisque	—	SC7	—	—	—	SC7	—	—	SC7	—	—	SC7	SC7	—	—
Chocolate	SC4	SC4	SC4	—	SC4	SC4	—	—	SC4	SC4	—	SC4	SC4	SC4	—
Fog	—	—	—	—	—	—	SC27	—	—	—	SC27	—	—	—	—
Lagoon	SC15	SC15	SC15	—	SC15	SC15	—	—	SC15	SC15	—	SC15	SC15	SC15	—
Latte	SC20	SC20	SC20	—	SC20	SC20	—	—	SC20	SC20	—	SC20	SC20	SC20	—
Lemon	—	SC25	—	—	—	SC25	—	—	SC25	—	—	SC25	SC25	—	—
Navy	SC5	SC5	SC5	—	SC5	SC5	—	SC5	SC5	SC5	—	SC5	SC5	SC5	SC5
Pacific	—	SC22	—	—	—	SC22	—	—	SC22	—	—	SC22	SC22	—	—
Red	SC19	SC19	SC19	—	SC19	SC19	—	—	SC19	SC19	—	SC19	SC19	SC19	—
Slate	SC8	SC9	SC8	—	SC8	SC9	—	SC8	SC9	SC8	—	SC9	SC8	SC8	SC9
Sterling	SC18	SC18	SC18	—	SC18	SC18	—	—	SC18	SC18	—	SC18	SC18	SC18	—
Tangerine	—	SC23	—	—	—	SC23	—	—	SC23	—	—	SC23	SC23	—	—
White	—	—	—	SC26	—	—	SC26	—	—	—	SC26	—	—	—	—

# COLOR PROGRAM

The following collections are available in the mesh color program: Amplify, Focus, Focus 2.0, Focus Side, Mavic, Movi, Novo, Qwiz, Torsa, Vectra, Wit and Wit Side. No minimum orders or additional costs apply.

## Mesh

	Amplify	Focus	Focus 2.0	Focus Side	Hexy	Mavic	Movi	Novo	Qwiz	Torsa	Vectra	Wit	Wit Side
<b>Solids</b>													
Apple	MC31	—	MC31	MC31	MC31	MC31	MC31	MC31	MC31	—	—	MC31	MC31
Aqua	MC30	—	—	MC30	—	—	MC30	MC30	MC30	—	—	MC30	MC30
Ash	—	—	MC45	—	—	—	—	—	—	—	—	—	—
Black	—	MC1	MC1	MC1	—	—	—	—	—	—	—	—	—
Charcoal	—	—	MC44	—	—	—	—	—	—	—	—	—	—
Desert	MC9	—	MC9	MC9	MC22	MC9	MC22	MC22	MC22	MC9	MC9	MC22	MC22
Dune	—	—	MC46	—	—	—	—	—	—	—	—	—	—
Electric Blue	MC24	—	MC13	MC24	MC24	MC13	MC24	MC24	MC24	—	—	MC24	MC24
Fire	MC10	—	MC10	MC10	MC25	MC10	MC25	MC25	MC25	MC10	—	MC25	MC25
Fog	MC7	—	MC7	MC7	MC23	MC7	MC23	MC23	MC23	MC7	—	MC23	MC23
Grape	—	—	—	—	—	—	MC26	MC26	MC26	—	—	MC26	MC26
Lemon	—	—	—	—	—	—	MC27	MC27	MC27	—	—	MC27	MC27
Midnight	—	—	MC43	—	—	—	—	—	—	—	—	—	—
Mist	—	—	—	—	—	—	—	—	—	—	MC41	—	—
Navy	MC8	—	MC8	MC8	MC8	MC8	—	—	—	MC8	MC8	—	—
Nickel	MC6	—	MC6	MC6	MC21	MC6	MC21	MC21	MC21	MC6	MC6	MC21	MC21
Ocean	—	—	MC29	—	MC29	MC29	MC29	MC29	MC29	—	—	MC29	MC29
Onyx	MC5	—	MC5	MC5	MC20	MC5	MC20	MC20	MC20	MC5	MC5	MC20	MC20
Platinum	—	—	—	—	—	—	—	—	—	—	MC42	—	—
Slate	—	MC2	MC2	MC2	—	—	—	—	—	—	—	—	—
Sand	—	MC3	MC3	MC3	—	—	—	—	—	—	—	—	—
Tangerine	MC28	—	MC28	MC28	MC28	MC28	MC28	MC28	MC28	—	—	MC28	MC28
<b>Stripes</b>													
Desert Stripe	—	—	—	—	—	—	—	—	—	MC16	—	—	—
Fog Stripe	—	—	—	—	—	—	—	—	—	MC15	—	—	—
Fog Woven Stripe	—	—	—	—	—	—	—	—	—	—	—	MC37	—
Freeway	—	MC33	MC33	MC33	—	—	—	—	—	—	—	—	—
Frost Woven Stripe	—	—	—	—	—	—	—	—	—	—	—	MC36	—
Impress	—	MC34	MC34	MC34	—	—	—	—	—	—	—	—	—
Nickel Woven Stripe	—	—	—	—	—	—	—	—	—	—	—	MC38	—
Onyx Stripe	—	—	—	—	—	—	—	—	—	MC14	—	—	—
Onyx Woven Stripe	—	—	—	—	—	—	—	—	—	—	—	MC35	—

# ARM ADJUSTMENT GUIDE

SitOnIt Seating offers a wide variety of arm styles and adjustments to accommodate all types of users doing a wide variety of tasks. The general adjustments for each arm type are described below. See the website or the product hang tag for specifics.

## Armless

Any discussion of arm styles must begin with armless. Armless chairs and stools are less expensive and are easier to get in and out of. However, they do not provide ergonomic support for long-term sitting and task functions.

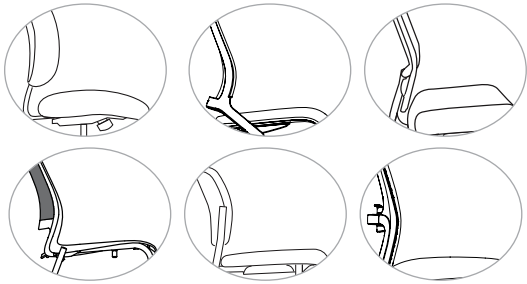

*Most chairs and stools are available armless, but the selection may be limited to specific models. For instance, Freelance multipurpose chairs and stools can be specified armless, but not Freelance bariatric chairs.*

## Fixed

As the name implies, fixed arms cannot be adjusted. Also known as loop arms, cantilever arms and other names, these arms are commonly found on side and multi-seating as well as basic task seating.

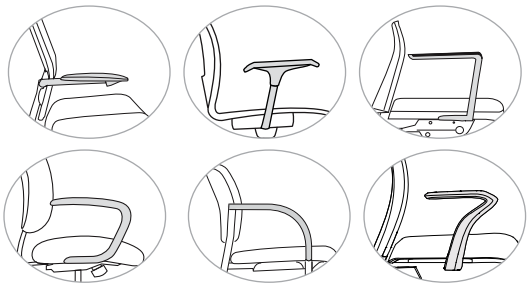

## Height-Adjustable

This is the most basic adjustable arm. The arm adjusts up or down. Height-adjustable arms are best for basic task work.

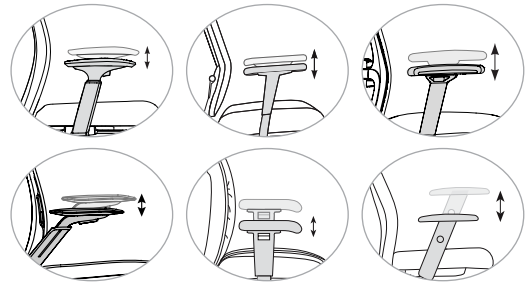

### INSTRUCTIONS:

#### **Glove Active, Knack, Non-Stop Heavy Duty, ReAlign, TR2 and Vectra**

- To increase or decrease the arm height, press the button and pull up or push down on the arm.

#### **Amplify, Focus, Focus 2.0, Vectra and Wit**

- To increase arm height, press the button located under the front of the arm pad and pull the arm up.
- To decrease arm height, press the button located under the front of the arm pad and push the arm down.

*Height-adjustable arms are available for Amplify, Focus, Focus 2.0, Glove Active, Knack, Non-Stop Heavy Duty, Novo, ReAlign, TR2, Vectra and Wit.*

# ARM ADJUSTMENT GUIDE

## Height-/Width-Adjustable | Multi-Adjustable

Height-/width-adjustable arms are sometimes called multi-adjustable arms on certain products. The arm adjusts up and down and side to side. This provides more “elbow room” for larger people. Best for basic task work.

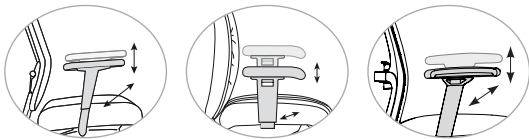

### INSTRUCTIONS:

- Height: See instructions in the height-adjustable section.
- Width: To adjust the arm width, push down the lever located under the seat to unlock the width adjustment. Move the arm to the desired width and pull up on the lever to lock the arm in place.

*Height-/width-adjustable arms are available for Focus, Glove Active, Knack, Non-Stop Heavy Duty, ReAlign and TR2.*

*Multi-adjustable arms are available for Amplify, Focus 2.0, Novo, Torsa and Vectra.*

## Height-Adjustable With Pivot

The arm adjusts up and down and 30-degrees in or out. The arms can be turned in to facilitate writing or keyboarding and turned out for other tasks.

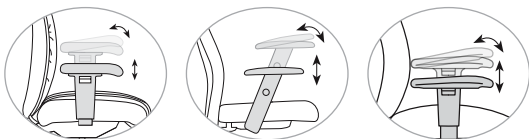

### INSTRUCTIONS:

- Height: To increase or decrease the arm height, press the button.
- Pivot: The armrest has three positions: 30-degrees in, center or 30-degrees out. To pivot the arm, grasp the arm pad and move it to one of the three positions.

*Height-adjustable arms with pivot are available for Glove Active, ReAlign and TR2.*

## Height-/Width-Adjustable With Pivot | Multi-Adjustable (Height/Width) With Pivot

This arm adjusts up and down, side to side and 30° in or out.

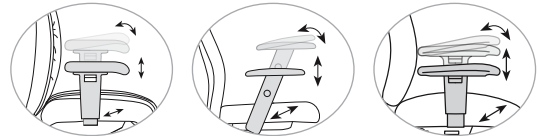

### INSTRUCTIONS:

- Height: The arm adjusts up or down. To increase or decrease the arm height, press the button.
- Width: The arm adjusts side to side. To adjust the arm width, push down the lever located under the seat to unlock the width adjustment. Move the arm to the desired width and pull up on the lever to lock the arm in place.
- Pivot: The armrest has three positions: 30° in, center or 30° out (Non-Stop Heavy Duty pivots 15-degrees). To pivot the arm, grasp the arm pad and move it to one of the three positions.

*Height-/width-adjustable arms with pivot are available for Glove Active, Non-Stop Heavy Duty, ReAlign and TR2.*

## Height-Adjustable Break-Away

The arm adjusts up or down and folds down 90-degrees. The folding arm allows for fast and easy ingress and egress and is also great for users with large key rings, tool belts or other personal gear.

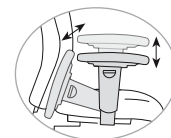

### INSTRUCTIONS:

- Height: The arm adjusts up or down. To increase or decrease the arm height, press the button.
- Break-Away: To fold the arm back, push down the lever located under the seat to unlock the arm and move the arm back. To return the arm to the original position, pull the arm up until it locks into place.

*Height-adjustable break-away arms are available for Non-Stop Heavy Duty (stool only).*

# ARM ADJUSTMENT GUIDE

## Multi-Adjustable (Height/Width) Articulating

The articulating arm adjusts up and down and side to side while the arm pad pivots left and right.

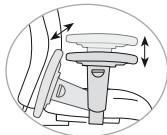

*Non-Stop Heavy Duty offers a multi-adjustable articulating arm option.*

## Fully Adjustable (6-Way)

The six fully adjustable arm adjustments are arm height (up/down), arm pad depth (forward/back) and arm pad side to side (in/out). This ergonomic arm is good for users engaged in a variety of task applications.

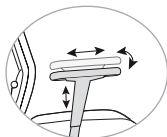

### INSTRUCTIONS:

- Height: The arm adjusts up or down. To increase or decrease the arm height, press the button.
- Arm pad depth: The arm pad slides forward or back.
- Width: The arm adjusts side to side.

*Fully adjustable (6-way) arms with arm pad depth adjustment are available exclusively on Focus.*

## Fully Adjustable (6-Way) With Pivot

The six fully adjustable arm adjustments are arm height (up/down), arm pad depth (forward/back) and pivot. This ergonomic arm is good for users engaged in a variety of task applications.

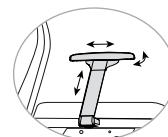

### INSTRUCTIONS:

- Height: The arm adjusts up or down. To increase or decrease the arm height, press the button.
- Arm pad depth: The arm pad slides forward or back.
- Pivot: The armrest has three positions: 25° in, center, or 25° out.

*Fully adjustable (6-way) arms with pivot are available on Sona and Prava.*

## Fully Adjustable (8-Way)

The 8-way fully adjustable arms go up/down for height adjustment while the arm pads go forward/back, in/out and pivot in/out for robust support. This all-encompassing arm style makes a perfect fit for today's workplace where broader work applications such as use of smartphones, tablets and other tech accessories are becoming the norm (and require complete forearm support). Pivoting of the arm pads also means that even the most petite of users can adjust accordingly for a more suitable fit.

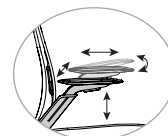

### INSTRUCTIONS:

- Height: The arm adjusts up or down. To increase or decrease the arm height, press the button.
- Arm pad depth: The arm pad slides forward or backward.
- Arm pad lateral: The arm pad moves in and out. Not to be confused with the arm width adjustment where the entire arm moves.
- Arm pad pivot: The arm pad pivots in and out to accommodate various work application postures.

*Fully adjustable (8-way) arms are available on Focus 2.0 and Vectra.*



## Fully Multi-Adjustable (10-Way)

The 10-way arm adjustments are arm height, arm width, arm pad depth, arm pad side to side and pivot. This is an excellent ergonomic task chair for executives or workers.

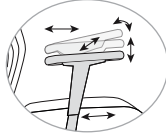

### INSTRUCTIONS:

- Height: The arm adjusts up or down. To increase or decrease the arm height, press the button.
- Width: The arm adjusts side to side. To adjust the arm width, push down the lever located under the seat to unlock the width adjustment. Move the arm to the desired width and pull up on the lever to lock the arm in place.
- Arm pad depth: The arm pad slides forward or back.
- Arm pad side to side: The arm pad slides from side to side. Not to be confused with the arm width adjustment where the entire arm moves.
- Pivot: The armrest has three positions: 30-degrees in, center or 30-degrees out. To pivot the arm, grasp the arm pad and move it to one of the three positions.

---

*Fully multi-adjustable (10-way) arms available exclusively on Focus.*

# MECHANISM FUNCTION GUIDE

SitOnIt Seating offers a wide range of function levels on our seating products. The descriptions and illustrations below are designed to introduce you to these mechanical functions and their primary advantages.

## Standard Synchro (F)

Use for a variety of task environments. This 1.5:1 ratio synchro offers simple features for the budget-conscious buyer.

### FEATURES

- Swivels 360°
- Gas cylinder seat height adjustment
- 1.5:1 seat to back synchronized recline movement
- Upright two-position tilt lock
- Tilt tension control
- Anti-kick feature
- Optional seat-depth adjustment on some models

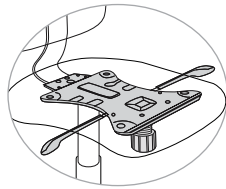

Standard synchro mechanism available on Hexy, Knack, Novo and Wit.

## Enhanced Synchro (Y)

Use for a variety of task positions and extended hours of usage. This 2:1 ratio synchro offers smooth and easy-to-operate adjustments combined with maximum user comfort while ensuring correct posture and support. Allows for a full range of movement.

### FEATURES

- Swivels 360°
- Gas cylinder seat-height adjustment
- 2:1 seat to back synchronized recline movement
- Upright two-position tilt lock
- Side tilt tension control
- Anti-kick feature

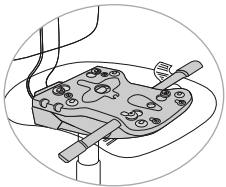

Internal back height adjustment not available on Focus and Prava.

Enhanced Synchro mechanism is available on Amplify, Focus, Focus 2.0, Glove Active, Knack, Prava, ReAlign, Sona, TR2 and Vectra.

## Enhanced Synchro with Seat-Depth Adjustment (Y/E3)

Ideal for a variety of task positions and extended hours of usage.

This 2:1 ratio synchro offers smooth and easy-to-operate adjustments combined with maximum user comfort while ensuring correct posture and support. Allows for a full range of movement.

### FEATURES

- Cable-driven control mechanism
- Swivels 360-degrees
- Gas cylinder seat height adjustment
- 2:1 seat to back synchronized movement
- Easy-to-adjust side activated tension control
- Upright two-position tilt lock
- Anti-kick feature
- Seat depth adjustment

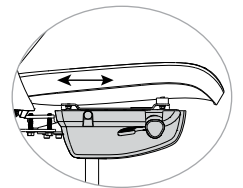

Enhanced Synchro with Seat Depth Adjustment is available on Amplify, Focus, Focus 2.0, Prava, Torsa and Vectra.

Internal back height adjustment not available on Focus and Prava.

Comfort Drive is available exclusively on Torsa.

## Advanced Synchro with Seat-Depth Adjustment (L/E3)

Use for today's variety of task positions and usages. Discover easy, intuitive adjustments with easy-to-reach, rapid-adjust controls for ongoing ergonomic support/comfort.

- Rapid-adjust tension knob with five positive clicks; experience tightest to loosest tension in fewer than two turns
- Easy-to-adjust tilt limiter knob with positive clicks; enables tilt-limitation and continuous support in five positions up to 19°
- 2.3:1 ratio synchro
- Swivels 360-degrees
- Built-in seat depth adjustment lever

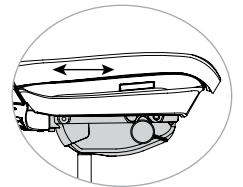

Advanced synchro mechanism available exclusively on Vectra.

# MECHANISM FUNCTION GUIDE

## Basic (Swivel Only) (B)

Use for short periods of time. Our most basic control has simple adjustments and works for casual meetings.

- Swivels 360-degrees
- Gas cylinder seat height

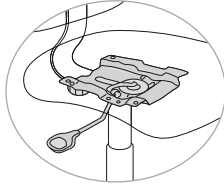

*Basic mechanism is available on Anytime, Focus, InFlex, Non-Stop, Novo, OnCall, ReAlign, Relay, TR2 and Wit.*

## Posture Back (P)

Ideal for shared workstations. Perfect for limited task applications. Independent back articulation ideal for extended stool models.

- Swivels 360°
- Gas cylinder seat height
- Infinite back angle adjustment
- Optional seat-depth adjustment

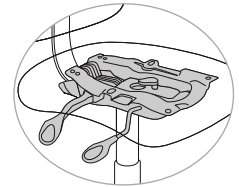

*The posture back mechanism is available only on TR2.*

## Swivel-Tilt (T)

Use for a variety of tasks and conferencing. Lean back and relax, or lock in the upright position and task with solid support.

- Swivels 360°
- Gas cylinder seat height
- Seat and back tilt as unit
- Tilt tension control
- Upright position tilt lock

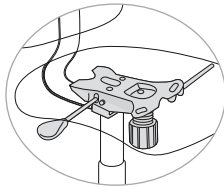

*Swivel-tilt mechanism available on Knack, ReAlign and Sona. Swivel tilt mechanism is available on Focus, Focus 2.0, Glove Active, Glove Executive, Knack, Mavic, Non-Stop Heavy Duty, Novo, OnCall, Prava, ReAlign, Relay, Sona and TR2.*

## Dual Torsion – Heavy Duty (DT)

Use for a variety of tasks and conferencing. Synchronized double-action rise allows full back recline for leg comfort and minimal front rise.

- Swivels 360-degrees
- Gas cylinder seat height
- Seat and back tilt as unit
- Upright position tilt lock
- Tilt tension control
- Reduced rise on front seat edge

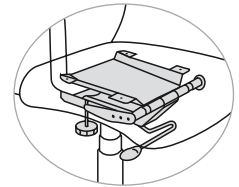

*Dual torsion heavy duty mechanism available only on Non-Stop Heavy Duty.*

## Knee Tilt (K)

Use for executive and managerial positions. The best of traditional tilt performance with a simple locking function. Allows for a full range of movement.

- Swivels 360°
- Gas cylinder seat height
- Seat and back tilt as unit
- Upright position tilt lock
- Tilt tension control
- Reduced rise on front seat edge

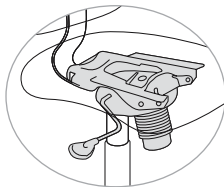

*Knee-tilt is available on Focus, Glove Executive, Prava, ReAlign, Sona and TR2.*

## Multi-Function (M)

Use for a variety of task positions and extended hours of usage. This control allows for an infinite range of movement and adjusts to a 5-degrees forward tilt.

- Swivels 360°
- Gas cylinder seat height
- Infinite back angle adjustment
- Seat and back tilt as unit
- Infinite position tilt lock
- Free floats in unlocked position
- Tilt tension control
- Seat pivots in a 5° forward position
- Optional seat depth adjustment

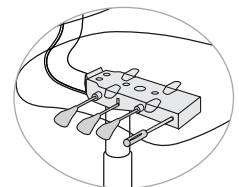

*Non-Stop Heavy Duty models have a manual back height adjustment. Multi-function mechanism available on Glove Active, Knack, ReAlign and TR2.*

## Weight-Activated (WA)

Let's replace it with: This control includes a weight-activated back recline tension control and a tilt-limiter function

- Height-adjustment
- Seat depth adjustment
- Recline tension override: if you need more or less tension than the one set by the mechanism automatically
- Tilt limiter sets how far the chair can be reclined

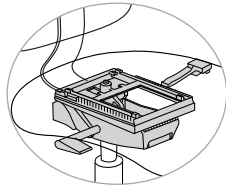

### INSTRUCTIONS:

- Recline tilt limiter: The tilt limiter is integrated into the height-adjustment control. Pull the paddle all the way out to lock the chair to a fully upright position. The three grooves in the handle correspond to three tilt ranges. Push the paddle in and the mechanism will subtly click into the groove when adjusted, locking in the range.
- Recline tension override feature: Pull the control out of its stowed position and turn to your right (clockwise from seated position) to increase the amount of tension. The mechanism has a total range of 18 half-turns. The default setting is five half-turns, which is perfect for shared collaborative applications. For longer task applications, try three more halfturns to the right.
- Height-adjustment: Facing forward, the single control paddle is under the seat on the right. Pull up on the paddle to adjust. Stand slightly to raise the seat. Sit to lower the seat.
- Seat slider: While seated, locate the tab on the left side of the chair. Pull lever out to adjust the seat position. Slide seat forward or back to desired setting.

*Weight-Activated mechanism available on Mavic.*

# EXECUTIVE AND CONFERENCE CHAIR OPTIONS

		GLOVE ACTIVE	GLOVE EXECUTIVE	HEXY	PRAVA	SONA	TR2 EXECUTIVE
BACK OPTIONS	Midback						
	Highback						
	Ballistic Nylon Back						
	Mesh Back						
	Plastic Back						
	Knit Back						
	Upholstered Back						
	Headrest						
	Pull Bar						
	HD	Heavy Duty (350 lb)					
SEAT	+1" Seat Foam						
	Upholstered Seat						
MECH + SEAT ADJ	Enhanced Synchro						
	Multi-Function						
	Posture Back						
MECH	Enhanced Synchro						
	Basic						
	Swivel-Tilt						
	Knee-Tilt						
	Multi-Function						
	Posture Back						
FRAME	Black						
	Fog						
	White						

		GLOVE ACTIVE	GLOVE EXECUTIVE	HEXY	PRAVA	SONA	TR2 EXECUTIVE
FIXED ARMS	Armless						
	Fixed						
	Fixed Loop						
ARM ADJUSTMENT OPTIONS	Height						
	Height With Pivot						
	Multi (4-Way)						
	Multi (4-Way) With Pivot						
	Fully (6-Way)						
BASE OPTIONS	Black Nylon						
	Fog Nylon						
	Silver Metallic						
	White Nylon						
	Brushed Aluminum						
	Polished Aluminum						
	Higher Cylinder						

# TASK CHAIR OPTIONS

		AMPLIFY	ANYTIME	FOCUS	FOCUS 2.0	HEXY	INFLEX	IONIQ	KNACK	LUMIN	MAVIC	MOVI	NON-STOP	NOVO	ONCALL	ORBIX	REALIGN	RELAY	RIO	TORSA	TR2	VECTRA	WIT	
BACK OPTIONS	Midback																							
	Highback																							
	Ballistic Nylon Back																							
	Mesh Back																							
	Plastic Back																							
	Thintex Back																							
	Upholstered Back																							
	Adjustable Lumbar																							
HD SERIES	Heavy Duty (350 lb)																							
	Large and Tall (400 lb)																							
	Extra Large (500 lb)																							
SEAT OPTIONS	+1" Seat Foam																							
	Large Seat Cushion																							
	Plastic Seat																							
	Upholstered Seat																							
MECH + SEAT-DEPTH ADJUSTMENT	Advanced Synchro																							
	Enhanced Synchro																							
	Standard Synchro																							
	Multi-Function																							
	Posture Back																							
MECH ADJUSTMENT NO SEAT ADJUSTMENT	Enhanced Synchro																							
	Standard Synchro																							
	Basic																							
	Swivel-Tilt																							
	Knee-Tilt																							
	Multi-Function																							
	Posture Back																							

# TASK CHAIR OPTIONS (CONT.)

	AMPLIFY	ANYTIME	FOCUS	FOCUS 2.0	HEXY	INFLEX	IONIQ	KNACK	LUMIN	MAVIC	MOVI	NON-STOP	NOVO	ONCALL	ORBIX	REALIGN	RELAY	RIO	TORSA	TR2	VECTRA	WIT	
<b>FRAME OPTIONS</b>	Accent Color																						
	Black																						
	Fog																						
	Graphite																						
	Silver																						
	White																						
<b>FIXED ARM OPTIONS</b>	Armless																						
	Fixed																						
	Fixed Loop																						
<b>ARM ADJUSTMENT OPTIONS</b>	Height																						
	Height With Pivot																						
	Multi (4-Way)																						
	Multi (4-Way) With Pivot																						
	Fully (6-Way)																						
	Fully (8-Way)																						
	Fully Multi (10-Way)																						
<b>BASE OPTIONS</b>	Black Nylon																						
	Fog Nylon																						
	Graphite Nylon																						
	Silver Nylon																						
	White Nylon																						
	Black Aluminum																						
	Brushed Aluminum																						
	Polished Aluminum																						
	Lower Cylinder																						
	Higher Cylinder																						

# TASK STOOL OPTIONS

		AMPLIFY	ANYTIME	FOCUS	FOCUS 2.0	HEXY	INFLEX	KNACK	LUMIN	MOVI	NON-STOP	NOVO	ONCALL	ORBIX	REALIGN	RELAY	RIO	TR2	WIT
BACK OPTIONS	Midback																		
	Highback																		
	Ballistic Nylon Back																		
	Mesh Back																		
	Plastic Back																		
	Thintex Back																		
	Upholstered Back																		
	Adjustable Lumbar																		
HD	Heavy Duty (350 lb)																		
SEAT OPTIONS	+1" Seat Foam																		
	Plastic Seat																		
	Upholstered Seat																		
MECH	Basic																		
	Posture Back																		
FRAME OPTIONS	Black																		
	Fog																		
	Silver																		
	White																		
	Accent Color																		
FIXED ARM OPTIONS	Armless																		
	Fixed																		
	Fixed Loop																		
ARM ADJUSTMENT OPTIONS	Height																		
	Height With Pivot																		
	Multi (4-Way)																		
	Multi (4-Way) With Pivot																		
	Fully (6-Way)																		
	Fully Multi (10-Way)																		



## TASK STOOL OPTIONS (CONT.)

		AMPLIFY	ANYTIME	FOCUS	FOCUS 2.0	HEXY	INFLEX	KNACK	LUMIN	MOVI	NON-STOP	NOVO	ONCALL	ORBIX	REALIGN	RELAY	RIO	TR2	WIT
BACK OPTIONS	Black Nylon																		
	Fog Nylon																		
	White Nylon																		
	Brushed Aluminum																		
	Polished Aluminum																		
	Stool Kit																		
	Extended Stool Kit																		

# MULTIPURPOSE CHAIR OPTIONS

		ACHIEVE	ANYTIME	BAJA	CORA	FOCUS SIDE	FREELANCE	FREELANCE BARIATRIC	INFLEX	IONIQ GUEST	IONIQ SIDE	LUMIN	MIKA	MOVI	ONCALL	ORBIX	QWIZ	RELAY	RIO	ROWDY	SPROUT	WIT SIDE	
BACK OPTIONS	Ballistic Nylon Back																						
	Mesh Back																						
	Plastic Back																						
	Upholstered Back																						
	Wood Back																						
SEAT OPTIONS	Plastic Seat																						
	Upholstered Seat																						
	+1" Seat Foam																						
HD SERIES	Heavy Duty (350 lb)																						
	Bariatric (500 lb)																						
	Bariatric (600 lb)																						
	Bariatric (750 lb)																						
	Bariatric (1000 lb)																						
FRAME OPTIONS	4-Leg																						
	4-Star																						
	Wire Rod/Sled																						
	Nester																						
	Bisque																						
	Black																						
	Chrome																						
	Fog																						
	Polished Aluminum																						
	Silver																						
	White																						
OTHER OPTIONS	Book Rack																						
	Ganging Bracket																						
	Stacking Cart																						
ARM OPTIONS	Armless																						
	Fixed																						
	Fixed Loop																						
	Tablet Arm																						

# MULTIPURPOSE STOOL OPTIONS

		ANYTIME	BAJA	FOCUS SIDE	FREELANCE	INFLEX	KICKSTAND	LUMIN	MIKA	ONCALL	ORBIX	RIO
<b>BACK OPTIONS</b>	Ballistic Nylon Back											
	Mesh Back											
	Plastic Back											
	Upholstered Back											
	Wood Back											
<b>SEAT OPTIONS</b>	Plastic Seat											
	Upholstered Seat											
	+1" Seat Foam											
<b>FRAME OPTIONS</b>	Bar Stool											
	Counter Stool											
	4-Leg											
	Wire Rod/Sled											
	Black											
	Chrome											
	Fog											
	Polished Aluminum											
	Silver											
<b>ARM OPTIONS</b>	Armless											
	Fixed											
	Fixed Loop											